

TENDER ISSUED TO: M/S _____

DATE: _____

**LIAQUAT UNIVERSITY OF MEDICAL AND
HEALTH SCIENCES**
JAMSHORO, SINDH

**CONSTRUCTION OF HOSTEL FOR MALE POST
GRADUATE STUDENTS AT LUMHS, JAMSHORO**
(CIVIL, PLUMBING & ELECTRICAL WORKS)

TENDER DOCUMENTS

1. NOTICE INVITING TENDER
2. SCOPE OF WORK
3. INSTRUCTION TO TENDERERS
4. SPECIAL CONDITIONS OF CONTRACT
5. SPECIAL STIPULATIONS
6. FORMS OF AGREEMENT / PERFORMANCE BOND
/ MOBILIZATION ADVANCE
7. TECHNICAL SPECIFICATION
8. LIST OF SPECIFIED MATERIAL
9. BILL OF QUANTITIES
10. FORM OF TENDER
11. TENDER DRAWINGS



YOUNG ASSOCIATES

CONSULTING ENGINEERS, ARCHITECTS & PLANNERS

9-C, 24TH COMMERCIAL STREET, PHASE – II (Ext.)

DEFENCE HOUSING AUTHORITY, KARACHI

PHONE # 021-35396444 , 021-35312244 Fax: 021-35883106

E-MAIL: info@youngassociates.com.pk

URL: www.youngassociates.com.pk

CONTENTS

SECTION	DESCRIPTION	PAGE NO.
I.	NOTICE INVITING TENDER	01 – 04
II.	SCOPE OF WORK	05
III.	INSTRUCTIONS TO TENDERERS	06 – 09
IV.	SPECIAL CONDITIONS OF CONTRACT	10 – 31
V.	SPECIAL STIPULATIONS	32 – 34
VI.	FORMS OF AGREEMENT/PERFORMANCE BOND/ MOBILIZATION ADVANCE	35 – 46
VII.	TECHNICAL SPECIFICATION	47 – 151
VIII.	LIST OF SPECIFIED MATERIAL	–
IX.	BILL OF QUANTITIES	
X.	FORM OF TENDER	
XI.	TENDER DRAWINGS	

SECTION – 1

NOTICE INVITING TENDER



LIAQUAT UNIVERSITY

OF MEDICAL AND HEALTH SCIENCES, JAMSHORO, SINDH-PAKISTAN

[URL:www.lumhs.edu.pk](http://www.lumhs.edu.pk)

[Tel:# 92-22-9213405](tel:92-22-9213405)

DOC#LUMHS/PMU/187

E-mail:pmu@lumhs.edu.pk

Issue Date:

PROJECT MANAGEMENT UNIT
22/11/2021

TENDER NOTICE

Sealed bids are invited from interested firms / contractors having vast experience in respective fields, registered with FBR, income tax department, Sindh Revenue board, valid registration with Electric license & registered with PEC in relevant category C-4 or above and discipline CE-10, CE-09 & EE-04, EE-06 on “single stage two envelope basis” for following works.

S.No.	Name of Works	Period for Completion
1.	Construction of Hostel for Male Post Graduate Students LUMHS Jamshoro.	15 Months

The tender documents can be obtained on payment of tender fee Rs. 5,000/- in shape of demand draft / Pay Order (Non-Refundable) in the favour of Vice Chancellors Liaquat University of Medical & Health Sciences, Jamshoro from the office of the Project Coordinator, Project Management Unit (PMU), 2nd floor institute of Dentistry, LUMHS, Jamshoro & can be download from SPPRA website i.e. <https://ppms.pprasinhd.gov.pk/ppms>, LUMHS website i.e. www.lumhs.edu.pk/tender on any working day from 1st December 2021 upto 16th December, 2021. The last date for submission of bids is 17th December upto 11:00 a.m.

The bids will be opened on the same day at 11:30 a.m. in the presence of all the bidders or their authorized representative.

The Financial Proposal of only technically qualified firms will be opened. Bid Security 5% of tender amount (refundable) in shape demand draft / pay order in the favour of Vice Chancellor Liaquat University of Medical & Health Sciences, jamshoro must be attached with bid document. The procuring agency may reject any bid subject to relevant provision of SPPRA rules 2010 amended 2019 and may cancel the bidding process at any time prior to the acceptance of Bid or proposal as per rules – 25(1) of said rules.

D.A / AS ABOVE.

**Project Coordinator
Project Management Unit
LUMHS, Jamshoro**

C.C. for information to:

- The Vice Chancellor, LUMHS, Jamshoro.
- The Registrar, LUMHS, Jamshoro.
- The Director Finance, LUMHS, Jamshoro.
- Sindh Public Procurement Regulatory Authority, Barrack 8 Secretariat 4A Court Road Karachi. Tel: 92-99205369 for hoisting on SPPRA's website.
- The Director I.T for hosting on LUMHS website.
- Notice Board.

CRITERIA OF QUANTIFICATION/QUALIFICATION

(a). The following documents should be attached with the Technical Proposal.

- i) Name of Firm, Postal Address, Telephone, Fax Number, E-mail Address and Organization Chart.
- ii) Legal Status of Firm.
- iii) Copy of valid PEC Contractor's License in category C-4 and discipline CE-09, CE-10, EE-04, EE-06, Electrical Inspectors License valid in Sindh (Mandatory).
- iv) Copy of NTN Certificate (Mandatory).
- v) Copy of Prequalification letters issued by other Govt. /Semi Govt. autonomous bodies and Organizations. (Building Works only)
- vi) Certificate of satisfactory completion of works by the clients. (Building Works only upto 50 Million)
- vii) List of Key Permanent Technical Staff Members along with their latest affidavit on judicial stamp paper of Rs.100/- that they are working with the applicant.
- viii) List of works completed in last five years with name and telephone No. of the clients and value of project (Mandatory). (Building Works only upto 50 Million)
- ix) List of work in hand including all details required in (viii) above. (building Works only)
- x) Affidavit on Rs.100/- Non Judicial Stamp Paper declaring that the firm has never been Blacklisted by any Govt./Semi Govt. Autonomous body or organization. (Mandatory).
- xi) List of Equipment/Plants available with the firms which can be verified.
- xii) Audit financial statement last 05 years.
- xiii) Bank Statement of last 05 years.
- xiv) Income Tax Return for last 05 years.

(b). Scope of Contract.

The Scope of Contract includes but not limited to the following:

- a. Construction of RCC structure
- b. finishing works
- c. Civil, Electrical, Firefighting & Plumbing works

- Note:**
- 1). Verification of the information provided by the applicants in the submissions for short listing may be made. In case the information is found to be wrong or incorrect in any material way or the applicant is found to be lacking in the capability or resources to successfully perform the contract, the application shall not be entertained.
 - 2). The document not containing Mandatories will not be entertained.

(c). Criteria for quantification & qualification

(a).	Legal Status of Firm	(Maximum 3 Points)
(i)	Limited Co.	3 Points
(ii)	Partnership	2 Points
(iii)	Individual	1 Point
(b).	PEC Registration C-4 (CE-09, CE-10)(EE-04.EE-06), Electrical Inspectors License	Mandatory
(c).	NTN Registration, SRB Registration	Mandatory
(d).	Certificate of completion of works (civil, plumbing & electrical works) with cost undertaken. (attached certificates) (Only Building Works more than 50 Million will be considered)	3 Point per Certificate (Max 15) Points.
(e).	List of works (civil plumbing & electrical works) in hand. Provide Documentary Evidence (work orders with cost) (Only Building Works more than 50 Million will be considered)	5 Point for each work order (Max 15 Points).
(f).	List of permanent technical Staff (a). Masters 3 Marks for each Engineer holding Masters Degree (b). Graduate 2 Marks for each Engineer holding Graduation Degree (c). Diploma Holder 1 Marks for each person having relevant certificate	Max 15 Points
(g).	Affidavit on Rs. 100/- stamp paper declaring that the firm has never been black listed.	Mandatory
(h).	List of equipment & plant (ownership document evidence is mandatory)	(Max 17 Points)
(i).	Concrete Mixers	2 Points
(ii).	Concrete Hoist	2 Points
(iii).	Vibrators	1 Point
(iv).	Tractor with Trolley	1 Point
(v).	Leveling instrument / Theodolite	1 Point
(vi).	Steel welding plant	1 Point
(vii)	Batching Plant	5 Point
(viii)	Shuttering (min. shuttering owned by contractor must be 100,000 sft including its vertical props)	4 Points
(i).	Average Annual Turnover of last 05 years from Audit Reports. (i). Above Rs. 100 million (ii). From Rs. 90 to Rs. 100 million (iii). From Rs. 70 to Rs. 90 million (iv). From Rs. 50 to Rs. 70 million (v). upto Rs. 50 million	(Max 25 Points) Full Points 25 Points 20 Points 15 Points 12 Points 10 Points
(j).	Bank Statements of last 05 years.	1 Points for each year (Max 5 Points)
(k).	Income Tax Returns (Last 05 Years).	1 Points for each year (Max 5 Points)
		100 Points

Qualifying Score: 75 Points

For Category C-4 (CE-09, CE-10) (EE-04, EE-06) and above

Signature with Official Seal

SECTION – 2

SCOPE OF WORK

SCOPE OF WORK

Liaquat University of Medical and Health Sciences, Jamshoro, Sindh intends to Construct **“HOSTEL FOR MALE POST GRADUATE STUDENTS”** in accordance with the drawings and specifications appended hereto.

The scope of contract for this bid shall be limited to Civil, Plumbing and Electrical works.

The Owner may increase or decrease the quantum of Work given in BOQ at his sole discretion at the rates quoted here in and no such increase or decrease shall give rise to any claim or compensation in this account.

The scope of work given in Contract Document includes items based on unit rates as indicated in schedule of rates, Govt. of Sindh (2012) for which Specifications of standing rates committee Govt. of Sindh be followed. (If Specification of any item is not indicated in Technical Specification of Tender Document) and / or items based on market rates for which Technical Specifications are given in the nomenclature and in section “Technical Specification”

The Contractor will be responsible for properly placing the location of the building as per Contour Plan and fix the plinth level in conjunction with the Bench Mark available at site as per the drawings provided by the Consultants and get it verified from them before taking up the works.

SECTION – 3

INSTRUCTIONS TO TENDERERS

INSTRUCTIONS TO TENDERERS

1. GENERAL

- 1.1 THE PROJECT MANAGER / PROJECT COORDINATOR, LUMHS, JAMSHORO, SINDH (hereinafter referred to as the "OWNER") through their Consultants viz YOUNG ASSOCIATES hereinafter referred to as "CONSULTANTS" invites from Contractors to submit tender for **"CONSTRUCTION OF HOSTEL FOR MALE POST GRADUATE STUDENTS"** as described in the scope of work in accordance with specifications and drawing requirements.
- 1.2 Tenders shall be prepared and submitted to the OWNER strictly in accordance with the instructions set forth herein.
- 1.3 All entries in the tender are to be in ENGLISH LANGUAGE, Corrections, overwriting etc, shall be signed by the authorized persons.

2. TENDER DOCUMENTS

The list of document indicated in the Form of Agreement shall form integral part of the agreement subsequently.

3. INSPECTION OF SITE AND LOCATIONS

- 3.1. The Tenderer shall inspect the site of work and surroundings and shall satisfy themselves before submitting their Tenders as to the qualities and nature of the work, the requirements and availability of manpower, labour, materials, water, electricity and roads, the means and access to the site. The tendered rates shall be considered to include all these factors as well as any, or all other factors which may influence the cost of construction.
- 3.2. The rates shall include the cost of all material, but in case, owner agrees to supply any or all the building materials to the Contractor, the deduction for the cost of these materials shall be made from the bills (Interim or final as the case may be) of the Contractor.

4. SUFFICIENCY OF TENDER

- 4.1. Each tenderer shall be deemed to have fully satisfied himself before submitting the Tender as to the Correctness and sufficiency of his Tender and of the rates and prices stated in the Bill of Quantities which rates and prices shall, except in so far as it is otherwise expressly provided in the Conditions of contract, must cover all his obligations under the Contract and all matters and things necessary for the proper completion of Project.
- 4.2. No tenderer shall have any right to make any objection, excuse or claim about correctness and sufficiency of his Tender after acceptance of his Tender by the OWNER.

5. VERBAL INSTRUCTIONS BE IGNORED

The Owner shall not assume any responsibility for information, interpretation and deductions the Tenderers may make from the data furnished by the Owner or the Consultants. No verbal understanding, agreement or conversation with any officer, employee or agent of the Owner or the Consultants, either before, during or after the execution of the Contract, shall affect or modify any of the terms or obligations contained in the Tender Documents.

6. EXPLANATION OF DOCUMENTS

Any tenderer who may have any doubt or question as to the true meaning of any part of the Tender Documents should deliver to the OWNER or the CONSULTANTS a written request for a clarification or answer thereof, prior to two days of the date set for opening of the Tender. Any explanations, revisions, additions or deletions to the tender documents will be made only by formal addendum, duly signed and issued with prior approval of OWNER and mailed or delivered to each tenderer who has received a set of Tender Documents. Such addendum will become an integral part of the Tender Documents and receipt thereof must be acknowledged by return of on the form issued with the addendum. Each addendum shall be signed by the Tenderers. The OWNER shall neither be responsible nor bound by any explanations, revisions, additions or deletions to the Tender Documents except those contained in the formal Addendum signed and issued by the OWNER or the CONSULTANTS.

7. DRAWINGS

The drawings showing the proposed work are also being issued with the Tender. The OWNER / CONSULTANT, however, reserves the right to make any addition, alteration or modification and / or deletion in these drawings, specifications and / or BOQ (Scope of work) at any time in the best interest of the work.

8. COST OF TENDERING

Tenderers shall have no claim for reimbursement of any expenses of any kind whatsoever incurred in connection with preparation and submission of their tenders.

9. INCOMPLETE TENDERS

Incomplete Tenders shall be liable for rejection by the Owner.

10. SUPPLY OF MATERIALS, WATER AND ELECTRICITY

- a). No materials of any kind what so ever required for execution of the work shall be supplied or arranged by the OWNER. It shall be the responsibility of the Tenderer to procure all materials required for timely completion of the work.
- b). The Contractor should make his own arrangements for water and electricity.
- c). If available electric supply and water may be supplied by the Owners the some may be shared with the contractor @0.25% for electric supply of the contract amount and 2 % for water supply service of the contract amount .

11. EARNEST MONEY

- 11.1. The original Tender shall be accompanied by Earnest Money 5% as specified in NIT in the form of Pay Order / Demand Draft issued by a Schedule Bank of Pakistan in favor of *The Vice Chancellor , Liaquat University of Medical and Health Sciences, Jamshoro, Sindh*. The money will be adjusted in Performance Guarantee of the successful bidders.
- 11.2. The Earnest Money will be refunded to unsuccessful bidders within 30 days from the date of opening of tenders.

12. SUBMISSION OF TENDER

The Tender Document duly signed on each page, corrections and overwriting alongwith the Earnest Money for the tender shall be properly signed and sealed and clearly marked as Technical & Financial Proposal and delivered in person or by registered mail or through Courier Service to the following address.

PROJECT MANAGEMENT UNIT
2ND FLOOR,
INSTITUTE OF DENTISTRY
LUMHS, JAMSHORO
PHONE: 022-9213405

so as to reach on or before the time and date given in the Notice of Tender at which time and place, they will be opened in the presence of such of the representatives of the Tenderers who may wish to be present. Only the name of the Tenderers and the Total quoted rates shall be announced by the OWNER at the time of opening of the Tender.

In case of any calculation errors detected during scrutiny of the Tenders, the unit RATE quoted by the Tender shall be taken as final and the tender value corrected accordingly.

13. AWARD OF CONTRACT

The OWNER does not bind himself to award the Contract to the lowest or to any other Tenderer but will take into consideration all aspects as are deemed relevant and applicable. Once the OWNER has arrived at the decision, he will issue a written letter of Award to the successful tenderer. Thereafter, the successful tenderer will be required to execute a formal agreement. Failure of the successful tenderer to sign the agreement within the prescribed time-schedule shall be a just cause for the annulment of the award of the contract and in the event of such annulment, the Earnest Money of the successful tenderer will be forfeited by and to the OWNER.

14. MOBILIZATION

If the tenderer to whom the Letter of Award is issued by the OWNER does not mobilize at the site of work within the stipulated time and take all appropriate steps to commence the work, the Earnest Money deposited by him along with his tender shall stand forfeited in favor of the OWNER as liquidated damages.

15. COMPLETION TIME AND COMPLETION CERTIFICATE.

- a). The work is to be substantially completed in all respects, in accordance with drawings and specifications, to the entire satisfaction of Engineer Incharge within the period set forth in the Tender. Failure of the Tenderer to complete the whole of the work within the specified time, will result in imposition and recovery of liquidated damages under the conditions of contract. This shall include amount payable to the CONSULTANTS as their remuneration on account of supervision services to be rendered for the period beyond the agreed date of completion, which will be proportionate to the supervision charges divisible by the period of completion on monthly basis.
- b). When the work is completed in all respects and handed over to the OWNERS the Consultant will issue the certificate that the works are substantially completed and Defect Liability Period will commence with effect from the date of issue of such certificate and will indicate the terminal date of such period.

16. MAINTENANCE PERIOD

The maintenance period of the work shall be 365 days effective from the date of issue of completion certificate by the Consultants.

17. SPECIAL STIPULATIONS

In case of doubt Special Stipulations will take precedence over all other conditions in Tender Documents.

SECTION – 4

SPECIAL CONDITIONS OF CONTRACT

SPECIAL CONDITIONS OF CONTRACT

1. DEFINITIONS AND INTERPRETATIONS

1.1. Definitions

In the Contract (as hereinafter defined), the following words and expressions shall all have the meanings herein assigned to them unless the context otherwise requires:

- a) "OWNER" means the M/s LUMHS, Jamshoro, Sindh legal successors and assignees.
- b) "CONSULTANTS" means M/S YOUNG ASSOCIATES, 9-C, 24th Commercial Street, Phase-II (Ext), DHA, Karachi, appointed by the OWNER as CONSULTANTS for the purpose of Technical assistance for supervision and management of the "WORKS" hereinafter defined.
- c) "ENGINEER" means the person or agency for the time being or from time to time designated or appointed in writing by the Consultant to represent them and to perform the duties set-forth in Article-4 hereof.
- d) "ASSOCIATE" means a firm / company hired to work in the trades of Electrical Installations / Air-Conditioning Installations or any other special trade having valid P.E.C. License in relevant category and also valid license issued by Electrical Inspector or by any other license granting Agency for the respective trades.
- e) "WORKS" means Construction of "**CONSTRUCTION OF HOSTEL FOR MALE POST GRADUATE STUDENTS**" LUMHS, Jamshoro, Sindh by virtue of the contract to be executed, whether temporary or permanent and whether original, altered, substituted or additional in accordance with the contract.
- f) "CONTRACTOR" means the person, firm or company whose Tender has been accepted by the OWNER and includes the contractor's representatives, successors and permitted assignees.
- g) "DRAWINGS" means the drawings showing the related details of architectural, structural, plumbing, electrical and mechanical services and other such works including the layout plans, elevations, sections, details, perspectives, sketches and other details and also the drawings referred to in the specifications and any modifications of such drawings approved in writing by OWNER / CONSULTANTS and such other drawings as may from time to time be furnished for approval in writing by the OWNER in Consultations with the CONSULTANTS.
- h) "SITE" means the land and other places on, under over, in or through the work s are to be executed or carried out and any other lands or places provided by the owner for the purpose of the Contract together with such other places as may be specified in or pursuant to the contract as forming part of the site.

- i) "TENDER" means the offer tendered by the Contractor for the Works governed by the Contract.
- j) "SPECIFICATIONS" means directions, provisions and requirements contained in the drawings or in the nomenclature or descriptions given in the contract documents and / or the verbal instructions of the Consultants.
- k) "CONTRACT DOCUMENT" means and includes the Letter of Work Award, agreement, conditions of contracts, specifications, schedule of quantities, Tender Drawings, details, sketches Performance / Bank Guarantee, Insurance Policies and all other papers pertaining to the construction work of this project. It shall also include any and all supplementary documents which may be necessitated to complete the work as required by the Owner through Consultant.
- l) "APPROVED" means approved in writing by Owner through Consultants.

2. SINGULAR & PLURAL

Words purporting the singular include the plural and vice-versa.

3. EXECUTION OF WORK

All works to be executed under the Contract shall be executed under the overall direction and subject to the approval in all respect of the OWNER.

4. ENGINEER

4.1. Duties and Power of the Engineer

The duties and power of the Engineer are to watch and supervise the Works and to test and examine any materials to be used or workmanship employed in connection with the works. He shall have no authority to relieve the contractor of any of his duties or obligations under the contract nor to make any variation of or in the works nor except as expressly provided hereunder order any works involving delay or any extra payment by the OWNER. The OWNER may from time to time in writing delegate to the Engineer through Consultant any of the powers and authorities and shall furnish to the contractor a copy of all such written delegations of powers and authorities and also of any revocation thereof.

Any written instructions or written approval given by the Engineer to the contractor within the terms of such delegations (but not otherwise) shall bind the contractor and the OWNER provided always as follows:

- i. Failure of the Engineer to disapprove any work or material shall not prejudice the power of the CONSULTANTS and the OWNER thereafter to disapprove such work or materials and to order the pulling down, removal or breaking up thereof.

- ii. If the Contractor shall be dis-satisfied by reason of any decision of the Engineer, he shall be entitled to refer the matter to the CONSULTANTS who shall thereon confirm, reverse or vary such decision. The CONSULTANTS's decision in such a case shall be final and binding upon the Contractor.
- iii. The fact that the CONSULTANTS or Engineer for whatever reasons, fail to detect defects in the layout or in the quality of the works executed shall not relieve the Contractor of his liability for rectifying the said defects in the layout or in the quality of the works at his own cost.

4.2. Emergency Powers of the Engineer.

Notwithstanding the provisions of Sections 4.1 hereof, if in the opinion of the Engineer an emergency occurs affecting the safety of lift or of the works or adjoining property he may direct the Contractor in writing to carry out all such work or to do all such things as may be necessary in his opinion to abate or reduce the risk. The contractor shall forthwith comply without appeal with any such direction of the Engineer.

5. CONTRACT DOCUMENTS

5.1. Language

The language according to which the Contract is to be construed and interpreted shall be English.

5.2. Documents Mutually Explanatory

The several documents forming Contract are to be taken as mutually explanatory of one another, but in case of ambiguities or discrepancies the same shall be explained and adjusted by the Consultant, who shall thereupon issue to the Contractor instructions directing in what manner the work is to be carried out. The provisions of special conditions of Contract shall prevail over the General Conditions of Contract and General Conditions over those of any other documents forming part of the Contract.

6. PERFORMANCE BOND

- a). The Contractor shall, within fourteen days after written Letter of Award has been issued by the Owner, provide a performance guarantee from a Scheduled Bank of Pakistan to be jointly and severally bound with the Contractor to the Owner for the due performance guarantee in the form appended to tender an amount equal to 5% (five percent) of the Contract Price.
- b). The Performance Bond shall be valid till the completion and end of the period of Maintenance. The cost of the Bond so entered into shall be at the sole expense, of the Contractor.
- c). No RA Bill will be processed unless the Performance guarantee is submitted.

6.1. INSURANCE OF WORKS ETC.

The Contractor shall, insure in the joint names of the Owner and the Contractor, against all loss or damage from whatever cause arising for which he is responsible under the terms of the contract and in such manner that the Owner and Contractor are covered during the period of the commencement to the completion of the works and are also covered during the period of Maintenance for loss or damage arising from a cause occurring prior to the commencement of the period of maintenance and for any loss or damage occasioned by the Contractor in the course of any operations carried out by him for the purpose of complying with his obligations.

- i) The works and temporary works to the full value thereof executed from time to time.
- ii) The maintenance, constructional plant and other things brought on to the site by the Contractor for the purposes of the contract to the full value of such materials, constructional plant and other things.
 - a) Provided always that without limiting his obligations and responsibilities as aforesaid nothing in this clause contained shall render the Contractor liable to insure against the necessity for the repair or reconstruction of any work constructed with materials or workmanship not in accordance with the requirements of the Contract.
 - b) Such insurance shall be effected with an insurer and in terms approved by the Owner and the Contractor shall whenever required produce to the Owner the original policy or policies of insurance and the receipt for payment of the correct premiums. The contract price shall be deemed to include in the Contractor's cost for the provision of such insurance.
 - c) All money received under any insurance mentioned in the Section shall be applied in or towards the cost of making good the loss or damage which has occurred but this provision shall not affect the contractor's liabilities under the contract.

6.2. DAMAGE TO PERSONS AND PROPERTY

The Contractor shall (except if and so far as the contract otherwise provides) indemnify and keep indemnified the Owner against all losses and claims for injuries or damage to any person or any property whatsoever which may arise out, or in consequence, of the performance of the Contract and against all claims, demands, proceedings, damages, costs, charges and expenses whatsoever in respect thereof or in relation thereto. Provided always that nothing herein contained shall be deemed to render the Contractor liable for or in respect of or to indemnify the Owner against any compensation or damages for or with respect to:

- i) The permanent use or occupation of land by the work for any part thereof.
- ii) Surface or other damage (caused by tenants or occupiers) to land or plants within the site which land or plants will be disturbed or damaged as an unavoidable result of the execution of the works.

- iii) The right of the Owner to construct the work for any part thereof on, cover, under, in or through any land.
- iv) Interference, whether temporary or permanent with any right of light, air, way, water or support or other easement or quasi easement which is the unavoidable result of the performance of the contract.

6.3. a) THIRD PARTY INSURANCE

Before commencing the execution of the works, the contractor shall, without limiting his obligations and responsibilities insure and, of the duration of the performance of the Contract, keep insured, in the joint names of the Owner and the Contractor against any damage, loss or injury which may occur to any property or to any person (including any employee of the Owner or Engineer or Consultants) by or arising out of the execution of the works or temporary works.

b) MINIMUM AMOUNT OF THIRD PARTY INSURANCE.

Such insurance shall be effected with an insurance company of AA rating and in terms approved by the Owner and for at least the amount stated in the Tender and the Contractor shall whenever required produced the original policies of insurance and the original receipts for payment of the current premiums. The Contract prices shall be deemed to include the contractor's costs of premium and incidental to the provision of such insurance.

6.4. a) ACCIDENT OR INJURY TO WORKMEN

The Owner shall not be liable for or in respect of any damage or compensation payable in law in respect or in consequence of any accident of injury to any workman or other person in the employment of the Contractor or any of his sub-contractors and the Contractor shall indemnify and keep indemnified the Owner against all claims, demands, proceedings, costs, charges and expenses whatsoever in respect thereof or in relation thereto.

b) INSURANCE AGAINST INJURY TO WORKMEN

The Contractor shall insure against any such liability with an insurer approved by the Owner and shall continue such insurance during the whole of the time that any persons that are employed by him on the works and shall when required produce to the Owner, in original, such policy of insurance and the receipt for payment of the current premium. Provided always that in respect of any persons employed by any of his sub-contractors, the Contractor's obligation to insure as aforesaid under this clause shall be satisfied if the sub-contractor shall have insured against the liability in respect of such persons in such manner that the Owner is indemnified under the policy but the Contractor shall require such sub-contractor to produce in the original to the Owner when required such policy of insurance and the receipt for payment of the correct premium. The contract price shall be deemed to include the costs of such insurance by the Contractor and his sub-contractors.

6.5. a) REMEDY ON CONTRACTOR'S FAILURE TO INSURE

If the Contractor fails to effect and keep in force the insurances or any other insurance which he may be required to effect under the terms of the contract or any applicable Laws / Bye-Laws, then in any case the Owner may (without prejudice to any other right or remedies) effect and keep in force such insurance and pay such premium or premiums as may be necessary for that purpose and from time to time deduct the amount so paid by the Owner as aforesaid from any moneys due or which may become due to the Contractor or recover the same as a debt due from the Contractor.

b) CONTRACTOR TO NOTIFY INSURERS

The Contractor shall notify the insurers of any of the insurance any matter or event which by the terms of such insurances are required to be so notified and the Contractor shall indemnify and keep indemnified the Owner against all losses, claims, demands, proceedings, costs, charges and expenses whatsoever arising out of or resulting from any default by the Contractor in employing with the requirements of this Section whether on account of the avoidance of any such insurance or otherwise.

7. DAMAGE TO PERSONS AND PROPERTY

The Contractor shall (except if and so far as the contract otherwise provides) indemnify and keep indemnified the Owner against all losses and claims for injuries or damage to any person or any property whatsoever which may arise out, or in consequence, of the performance of the Contract and against all claims, demands, proceedings, damages, costs, charges and expenses whatsoever in respect thereof or in relation thereto. Provided always that nothing herein contained shall be deemed to render the Contractor liable for or in respect of or to indemnify the Owner against any compensation or damages for or with respect to:

- i) The permanent use or occupation of land by the work for any part thereof.
- ii) Surface or other damage (caused by tenants or occupiers) to land or plants within the site which land or plants will be disturbed or damaged as an unavoidable result of the execution of the works.
- iii) The right of the Owner to construct the work for any part thereof on, cover, under, in or through any land.
- iv) Interference, whether temporary or permanent with any right of light, air, way, water or support or other easement or quasi easement which is the unavoidable result of the performance of the contract.

8. GENERAL OBLIGATIONS

8.1. Agreement

The Contractor shall, within fourteen days after the written Letter of Award has been issued to him by the OWNER, enter into and execute an Agreement (to be prepared at the cost of the Contractor) in the form appended to the Tender with such modifications as may be considered necessary by the OWNER.

8.2. Site Information

The Contractor shall be deemed to be in possession of all necessary information of the site and its surrounding, to have satisfied himself as to the nature of roads and as to possible interruptions thereto and the access to and exist from the site, to have made inquiries as to the available accommodation for his staff and labour, to have made inquiries as to the sub soil water levels and the variations thereof, and drains, storms, prevailing winds, climatic conditions generally and other similar matters, to have satisfied himself as to the courses and means of obtaining adequate supplies of skilled and unskilled labour and also all materials required for the works and the transport thereof, to have considered the possibility of delays or inconvenience that may be caused to his operations by any reasons of the breakdown of communications, storms, floods, adverse weather conditions to have acquainted himself as to his liability for payment of Government taxes another charges, to have examined the contract document generally to have obtained information on all matters whatsoever that might affect the carrying out of the works. The Contractor shall not be entitled to any claim if he fails to fulfill his obligation in acquiring the information before submitting his tender.

8.3. Works to be done to the satisfaction of the OWNER

The Contractor shall execute, complete and maintain the Works in strict accordance with the Contract to the satisfaction of the OWNER and the whole of the materials, plant, labour and other things to be provided by the Contractor in pursuant to the Contract and the mode, quality, manner and speed of execution and maintenance of the Works shall be of a kind conducted in a manner to the satisfaction of the OWNER and CONSULTANTS.

8.4. Compliance with CONSULTANT'S Instructions

The Contractor shall comply and adhere strictly to the CONSULTANT's instructions and directions (subject to the limitations referred to hereof) from the Resident Engineer on behalf of the OWNER regarding any matter (whether mentioned in the Contract or not) touching or concerning the Works.

8.5. a) Contractor's Agent

The Contractor shall with the approval of the CONSULTANTS (which approval may at any time be withdrawn) employ and arrange whole-time presence of a duly authorized agent or representative at the Site. The said agent or representative shall give his whole time superintendence to the Works and shall act in harmony with the CONSULTANTS and the OWNER. The said agent or representative shall not be removed by the Contractor from the Works or the Site without consent in writing of the CONSULTANTS.

b) Agent to Receive Instructions

The Agent and representative shall receive on behalf of the Contractor the instructions of the OWNER / CONSULTANTS or (subject to the limitations of Article 3, 4, 5 hereof) the Engineer.

8.6. Contractor's Employees

The Contractor shall employ in and about the execution and maintenance of the Works and provide at the Site:

- i. Only with technical assistants, foremen and leading hands as are careful, skilled and experienced in their respective trades and are competent to give proper supervision to the work they are required to supervise, and
- ii. Such skilled, semi-skilled and unskilled labour as necessary for the proper and timely performance of the Contract.

8.7. Assignment and Sub-Letting Assignment

The Contractor shall not assign the Contract or any part thereof or any benefit or interest therein or there under without the prior written consent of the Owner.

Subletting

The contractor shall not sub-let the whole of the works, except where otherwise provided by the Contract. The Contractor shall not sub-let any part of the works without the prior consent of the Owner and such consent if given not relieve the Contractor from any liability or obligation under the contract and he shall be responsible for the acts, defaults and neglects of any sub-contractor, his agents, servants or workman.

8.8. Security Deposit

- a). The Security Deposit of the contractor to be retained by the Owner shall be 5% of the total cost of the work carried out by the Contractor and it shall be deducted from each of the interim bill as well as from the final bill submitted by the Contractor and shall be retained by the Owner until the expiry of Defects liability period as guarantee of the good workmanship and good material used for the construction of project.
- b). 50% Amount of Security Deposit will be released after issuance of certificate of substantial completion of works by the Consultants.
- c). 50% Amount of Security Deposit will be released after completion of Defects Liability Period and after proper handing over by the Contractor and taking over by the Owner in writing.

9. MODE OF PAYMENTS

The Contractor shall submit 3 (three) copies of the Interim Bill accompanied by three copies of the details of measurement to the Consultants after completion of about one tenth (1/10th) portion of the total work. The Consultants shall scrutinize the same and issue to the Contractor the Certificate of payment on the basis of this scrutiny without prejudice to any of the rights of the Owner.

The payment made on the basis of interim bills shall be regarded as an advance against the total cost of work till the final bill is scrutinized and the cumulative amount paid by the Owner to the Contractor shall be adjusted against the overall amount of the final bill.

10. TIME ALLOWED FOR COMPLETION

The time allowed for completion and handing over the work complete in all respects to the Owner shall be as specified and shall be deemed to be effective from the date of Letter of Award. The contractors shall commence the work within 7 (seven) days of award of work. In case the contractor fails to commence the work within the stipulated time, the contract may be awarded to any other tenderer or party which in the opinion of the Consultants serves the best interest of the Owner. Earnest Money will be forfeited in favour of the OWNERS.

11. EXTENSION IN COMPLETION TIME

The Owner on the recommendations of Consultant reserves the right to refuse / grant reasonable extension in completion time under special circumstances which the CONSULTANTS / OWNER deem to regard as beyond the control of the contractor, and the Contractor has within One month after such circumstances have arisen or as soon thereafter as is practicable, delivered to the consultants full and detailed particulars of any claim to extension of time to which he may consider himself entitled in order that such claim may be investigated at that time.

12. PENALTY

(a) Penalty to the client

The completion time stipulated is the essence of this contract and for each day for which the work remains un-commenced or unfinished after the proper dates, the Contractor shall pay to the Owner a sum of Rs.0.05% (Point Zero Five Percent) of the contract value per day till such time the Project is completed in all respects and formally be handed over to the Owner, subject to a maximum of 10 % of the cost of the total works.

(b) This shall include penalty payable to consultant as per clause 15 page 7 of Instruction to Tenderers.

13. CONSTRUCTION SCHEDULE

Within 10 (ten) days of the Award of the work, the contractor shall submit to the Consultants a detailed phasing of the Construction programme he propose to adopt for completing the project within the stipulated period.

If the Consultants are not satisfied with this programme they may ask to revise the same to their satisfaction and the Contractor shall carry out the changes accordingly and will strictly adhere to this programme throughout the progress of the construction work. The Contractor will pay Rs.500/- (Rupees Five Hundred Only) per day for the delay beyond 15 days after the date of work order / Agreed Date of Commencement.

14. RIGHT TO ACCESS

The Owner and the Consultants reserve the right to enter upon the site at all times and the contractor or his representatives shall extend them all the cooperation for inspection of the quality and the progress of the Construction works.

15. REMOVAL OF EMPLOYEES WORKMEN AND FOREMEN.

The Owner / Consultant shall have full powers at all times to object to the employment of any of the workmen, foremen or other employees on the works by the contractor and if the contractor shall receive a notice from the consultants, requiring the removal of any person or persons from the works, the contractor shall comply with the instruction forthwith. The Contractor shall not be entitled to demand the reason from the consultants for such notice.

16. SETTING OUT

The Contractor shall be fully responsible for correctly setting out the work on the site as per dimensions indicated in the drawings and if any error is found at any stage of the work, the contractor shall rectify the same at his own risk and expense accordingly.

17. DISCREPANCY IN DRAWINGS

Only the written dimensions shall be followed for all the drawings and details. However, it will be the responsibility of the Contractor to study, check and tally the drawing/details issued to him by the consultants. Before proceeding with the construction, he shall be deemed to have thoroughly satisfied himself about the accuracy of all drawing/details. If any discrepancy is detected by him, he should immediately bring it to the notice of the consultants and get the same rectified before proceeding with the work or else the responsibility for the faulty construction shall rest with the contractor.

18. REPLACEMENT OF DEFECTIVE WORK

The Contractor shall be responsible for strictly observing his obligations as regards the correct interpretation of the drawings, details, specifications, schedule of quantities or any other relevant part of the contract documents. If during the progress of the work any defect is discovered either in the use of materials or the workmanship the contractor shall at once demolish such work on receiving instructions from the Owner, Agent or their accredited representative & replace the same as directed.

19. OWNER'S RIGHT TO IMPOSE PENALTY MEASURES

The Contractor shall strictly carry out the entire work according to the tender documents. However, at any stage of the execution of the work, if it is discovered that work carried out by the Contractor as regards the materials or the workmanship, or both, is not as per the drawings, details, specifications, and the instructions of the Owners agent, the Owner reserve the right to impose the lump-sum penalty on the contractor disown / order to dismantle, or to reduce the tendered rates of the contractor to commensurate with the actual quality of the work as carried out by the Contractor.

20. GUARANTEE FOR GOOD MATERIALS AND WORKMANSHIP

The Contractor shall execute a guarantee specimen draft valid for entire liability period after completion and handing over the works to the owner as regards the use of good construction materials and workmanship for the entire work, if any defect is discovered after completion within the said period, the Contractor shall replace the defective works at his own expenses. However, in the event of the failure on the part of the Contractor to rectify and replace the defective works, the Consultants may advise the owner to rectify the same at the expenses of the Contractor and to adjust such amount from his Security Deposit. In case the cost of replacement of defective works exceeds the amount of Security Deposit lying with the owner, the extra, expenditure so incurred shall be recovered from the Contractor.

21. CLERK OF WORK

The Owner may appoint the Site Engineer or site supervisor who may henceforth be referred to as the clerk of works, under the orders of the Owner and having the powers and authority so delegated to him by the Owner. The duties of the clerk of works shall be to inspect and supervise the works according to the specifications laid down by the Consultants. He shall have no power to relieve the Contractor of any obligation under the Contract nor to make any variation order nor to order any work involving delay or extra expenditure.

22. INTIMATIONS FOR INSPECTION

The Contractor shall inform the Owner when any parts of the work is ready for checking. No earth shall be backfilled until the Owner agent has inspected the foundations and plinth work. Any part of the work which shall not be visible in the subsequent stage of its completion shall be got inspected / measured by the Consultants.

23. OBSERVANCE OF CONSULTANTS / OWNER INSTRUCTIONS

The Contractor shall abide by the instruction of the Consultants / Owner or their duly accredited engineer or representatives as regards the progress and quality of the Construction. No work shall be continued without the approval of the Consultants / Owners. No concrete shall be poured in R.C.C. structures unless the reinforcement is checked and approved by the Consultants / Site Engineer in writing (Pour Slip).

24. PROGRESS REPORT AND PHOTOGRAPHS

The Contractor shall regularly submit to the Consultants every week, the progress reports in quadruplicate so as to reach them in the first working day of every month. If the Owner find the progress slow as compared to the Construction schedule already submitted and approved he may instruct the Contractor to increase the rate of progress and warn him about the possible enforcement of penalty clause and in that case the Owner shall take the necessary measures to accelerate the work. In the event of failure by the Contractor to comply with such instruction or such warnings, the penalty clause shall be strictly imposed upon the Contractor if the contractor falls behind the stipulated completion period. The report of every fourth week shall be fully supported with photographs of post card size depicting the completed stages of the work. No R.A Bill of Contractor shall be processed unless the photograph and monthly progress report are submitted on regular basis.

25. (A) MEETINGS ON PROGRESS OF WORK

The Contractor and his Agent shall attend any or all meetings when called by the Owner to discuss progress of the work and other matters related to the works and the contract.

(B) LIQUIDATED DAMAGES FOR DELAY.

Time shall be deemed to be the essence to the contract.

- a) It is agreed that the amounts specified hereinafter are reasonable compensation to the Owner without reference to the actual loss or damage sustained and whether or not any damage has or has not been sustained.
- b) If the work remains un-commenced at the expiry of the commencement period stipulated in the Tender, the contractor shall be liable (in addition to any other penalties liable under the contract) to pay to the Owner a sum of Rs.0.05% (Point Zero Five Percent) of the contract value for each day that the work remains un-commenced provided that the maximum amount under this sub-clause (excluding penalty or penalties under other sub-clause) shall not exceed 10 % (ten percent) of the contract price of the work.
- c) The contractor shall ensure good progress during the execution of the works and shall be bound in all cases to strictly comply with the programme submitted by him and approved by the owner under this contract.

In case the execution of work falls so much in arrears, behind the programme so as to necessitate a fresh programme the approval by the Owner of the revised programme shall not be deemed to prejudice the power of the Owner to levy penalty under this sub-clause with scale prescribed in sub-clause(c) above and the contractor shall remain liable to pay, Rs.0.05% (Point Zero Five Percent) of the contract value per day for the period revised programme had not been approved.

- d) If the Contractor shall fail to complete the works within the time prescribed by section 10 hereof or extended time, then the contractor shall pay to the Owner liquidated damages for such default and not as a penalty of Rs.0.05% (Point Zero Five Percent) of the contract value for each calendar day which shall elapse between the time prescribed by section 10 hereof or extended time as the case may be and the date of completion of the works but not exceeding a maximum of ten percent (10%) of the contract price. The Owner may, without prejudice to any other method of recovery deduct the amount of such damages from any moneys in his hands due or which may become due to the contractor. The payment or deduction of such damages shall not relieve the contractor from any other of his obligations and liabilities under the contract.
- e) If the contractor fails to complete the works in all respects or abandons in an incomplete state, or where his contract is rescinded due to breach of contract, the contractor shall be liable to pay to the Owner a sum equal to 10 % (Ten Percent) of the contract price as penalty.
- f) The Contractor shall not claim exemption from the penalties as aforesaid without obtaining a written approval of the Owner. Mere fact that the contractor has applied for such exemption would be granted. No such application for exemption shall be considered unless it is submitted within 15 days of the occurrence of the handicap resulting in the levy of penalty.
- g) The Owner may without prejudice to any other method or recovery, deduct the amount of the penalties including the amount paid to the consultant as remuneration for supervision beyond the time of completion as prescribed by the section 10 hereof or extended time as aforesaid from any moneys in their hand due or which may become due to the contractor.
- h) The contractor shall pay a penalty in terms of liquidated damages to the consultant for the supervision service rendered beyond the agreed date of completion as per clause 15 page 7 of Instruction to Tenderers.
- i) The payment or deduction of such penalties and / or liquidated damages shall not relieve the contractor from his obligation to complete the works or from any other of his obligation and liabilities under the contract.

26. VALUABLE / ANTIQUES ETC

If during the excavation on the site any valuable or antiques are found, their ownership shall rest with the owner and the Contractor shall immediately hand these over to the owner (where applicable).

27. SUB CONTRACTING

The sub-contracting of this work or part thereof shall not be allowed, however, in case the Contractors wants to sub-contract a part of the work, requiring specialized experience, he may ask for the permission of the Consultants / Owner to do so, but in no case the Contractor shall sub-contract with the work or any part thereof without the permission of the Consultants / Owner.

28. STORAGE

It shall be the responsibility of the Contractor to protect the materials stored on the site for the use at appropriate stage of work, against weathering for that he shall provide adequate storage depots on the site at his own expenses. In the event of the damage to these materials on account of negligence of the Contractor, the consultants shall order for removal of the materials from the site and replacement with fresh materials at the expense of the Contractor.

29. SAMPLES

The Contractor shall submit to Consultants for Owner's approval the samples of the material, fittings and fixtures which he may propose to use for the construction. He shall also provide the details of the origin of such samples to the consultant.

The Consultants may allow the use of these materials with the approval of Owners if he is satisfied with their quality. However, if he finds these samples not in conformity with the specification, he may reject them and ask the contractor to produce the required quality products. The contractor shall use only the materials fittings and fixtures of the approved quality.

30. USE OF SITE

The site handed over to the contractor by the owner for carrying out the tendered work shall not be used for any purpose other than the construction. Any activity other than related to the tendered work shall be considered to be illegal and tantamount to be the breach of the contract.

31. INDEMNIFICATION OF OWNER

The Contractor shall indemnify the owner in respect of all claims, damage, compensation or expenses by any workman or other persons in the employment of the contractor or not, while in vicinity or upon the said works or the site of the same and the owner shall not be responsible to defend all the suits, claims, damages etc. arising out of any activity or consequences thereof connected with the construction. Such activity shall include upon an alleged infringement of a prevented invention and or acts improperly carried out or omission to carry out a proper or delay in carrying out proper work.

32. SITE OFFICE AND STORAGE

The Contractor shall construct at his own expense the necessary site offices and toilet facilities both for his use and for the use of the owner. He shall also construct at his own expense the necessary godowns and storages and access roads if needed. He shall demolish if required by the owner all these structures and clear the site by removing debris.

33. TESTING OF MATERIALS

The contractor shall from time to time carry-out the testing of materials used for the construction as and when desired by the consultants at his own expenses, in the laboratories as approved by the consultants. In the event of the un-satisfactory test results, the consultants shall reject such materials and order demolition of the work constructed from these materials & further order the replacement of the same to meet the required specification at contractors own expense.

34. DEFECT LIABILITY

The Contractor shall be responsible for making good all the defects appearing within 365 days after the satisfactory completion of works. The security deposit of the contractor shall be retained until after the expiry of this defect liability period.

If the Contractor fails to rectify the defects which are brought to his notice by the Consultants, the owner shall get these defects rectified from the security deposit at the

risk of the Contractor. The owner may release the security deposit before the expiry of this period, in lieu of the suitable BANK Guarantee which shall be entirely to Owner's discretion.

35. FULFILLMENT OF CONTRACT

On completion of the contract work, the contractor shall intimate the owner in writing and arrange for joint inspection of the completed works by the owner & the consultants. On this inspection, the consultants shall scrutinize the completed work as regards its quality and adequacy in keeping with the contract documents.

If they find the completed works falling short of any of the specifications or other obligations under the contract, they may ask the contractor to rectify the same. If they find the works duly completed as per contract, they may issue the final certificate for payment to the contractor. However the fulfillment of contract shall not be considered until after the acceptance of the completed work.

36. FORFEITURE

If the contractor shall become insolvent to have an order admitting a petition in insolvency made against him or shall present his petition in insolvency or shall make an arrangement with or assignment in favour of his creditors or shall agree to carry-out the contract under a committee of inspection of his creditors or (being a corporation) shall go into liquidation (other than a voluntary liquidation for the purpose of amalgamation or reconstruction) or if the contractor shall assign the contract without the consent in writing of the owner first obtained or shall have an execution levied on his goods or if the consultant shall certify in writing to the owner that in his opinion the contractor.

- a) Has abandoned the contract, or
- b) Without reasonable excuse has failed to commence the work or has suspended the progress of work for 15 (fifteen) days after receiving from the consultant written notice to proceed, or
- c) Has failed to proceed with the works with due diligence, or
- d) Has failed to meet the desired schedule of progress of work, or
- e) Has failed to remove materials from the site or pull down and replace work for 15 (fifteen) days after receiving from the Owners through the Consultants written notice tht the said material or work has been condemned and rejected by the consultants under these conditions, or
- f) Is not executing the works in accordance with the contract or is persistently or flagrantly neglecting to carry out his obligations under the contract, or
- g) Has to the detriment of good workmanship or in defiance of the Engineer's instructions to the contrary sub-let any part of the contract, and so often as any of the events aforesaid shall occur, then the owner may adopt any of the following courses as it may deem best suited to the interest of the owner (without prejudice to any rights it may have against the contractor) after giving fifteen days notice in writing to the contractor.
 - i) Terminate the contract, enter upon the site and the works and expel the contractor there-from in which case the security deposit of the contractor shall stand forfeited and be absolutely at the disposal of the owner.
 - ii) Enter upon the site and the works and expel the contractor there-from without there by voiding the contract or releasing the contractor from any of his obligations or liabilities under the contract or affecting the rights and power conferred on the owner or the consultants by the contract and may itself complete the works or may engage any other contractor to complete the works at the risk and cost of the contractor.
 - iii) To complete the works or part of works by the owner at the cost of the contractor, viz to supply labour paid by the owner and to supply materials to carry out the works or any part of the works debiting the contractor with the cost (as hereinafter specified) of labour and materials and crediting with the value of the work done in all respects under same manner and at the same rates as if it had been carried out by the contractor under the terms of his Contract. For the purpose of this clause cost of labour shall be actual expenditure plus 25 % to cover overhead charges, if the materials have been supplied by the owner, the cost of material will be based on the market rate or stock issue rate whichever is greater plus 10 % overhead charges. The certificates of the authorized representative of the owner as to the value of the work done and as to the cost shall be final and conclusive against the contractor.

37. i) VALUATION OF VARIATION

The Consultants shall determine the amount (if any) to be added to or deducted from the sum named in the tender in respect of any extra or additional work done or work omitted by his order.

All such work shall be valued at the rate set out in the contract, if in the opinion of the consultants the same shall be applicable if the contract shall not contain any rates applicable to be the extra additional work then reasonable prices shall be fixed by the Consultants. This shall be with the approval of Owners only.

ii) POWER OF CONSULTANT TO FIX RATE

Provided that if the nature or amount of any omission or addition relative to the nature or amount of the whole of the contract work or to any part hereof shall be such that in the contract for any item or the works is by reason of such omission or additions rendered unreasonable or inapplicable the consultant shall fix such other rate or price as in the circumstances he shall think reasonable and proper. In the event of dispute the decision of the Owners shall be final.

38. VARIATIONS

a) CONTRACTOR NOT TO VARY WORKS.

The Contractor shall not make any variation in the works except in accordance with a written variation order of the Consultants duly approved by the Owner.

b) VARIATION ORDER

The Consultant with the prior approval of the Owner may from time to time make any variation in the form, quality or quantity of the works or any part thereof that may in his opinion be necessary and for that purpose or if for any other reason it

shall in his opinion be desirable shall have power by a written variation order to order the contractor to do and the Contractor shall do any of the following:

- i) Increase or decrease quantity of any work included in the contract.
- ii) Omit any such work.
- iii) Change the character or quality or kind of any such work.
- iv) Change the levels, lines, position and dimensions of any part of the work and
- v) Execute additional or substituted work of any kind necessary for the completion of the works.

c) (i) NOT TO INVALIDATE CONTRACT

No variation order shall in any way vitiate or invalidate the Contract but the value if any of all such variations ordered shall be taken into account in ascertaining the amount of the Contract price.

(ii) CHANGE IN QUANTITIES

No such variation shall be made by the Contractor without an order in writing of the Owners through Consultant or his authorized representative PROVIDED that no order in writing shall be required for increase or decrease in the quantity of any work where such increase or decrease is not a result of an order given under the clause but is the result of the quantities exceeding or being less than those stated in the bill of quantities.

Provided also that if for any reasons the Engineer shall consider it desirable to give any such order verbally, the Contractor shall comply with such order. Any confirmation in writing of such verbal order given by the Engineer whether before or after carrying out of the order shall be deemed to be an order in writing within the meaning of this clause.

(iii) NOTICE OF INTENDED CLAIMS

No claims for any variation shall be allowed except as per the provision contained in section 39. No increase of the Contract price under clause (iii) of this section shall be made unless as soon as practicable and not later than thirty days from the date of the variation order notice shall have been given in writing subject to the approval of the Owner.

(iv) CLAIMS

The Contractor shall send to the Consultant once in every month an account of full and detailed particulars of all claims for any additional expense to which the Contractor may consider himself entitled and of all extra or additional work ordered by the Consultant as per provision of clause (39) which he has executed during the preceding month and no claim for payment for any such work will be considered which has not been included in such particulars, provided always that the Consultant with the approval of the Owner shall be entitled to authorize payment to be made for any such work notwithstanding the Contractor's failure to comply with this condition if the Contractor has at the earliest practicable opportunity notified the Consultant that he intends to make claim for such work.

39. MEASUREMENT

(i) RECORD OF MEASUREMENT

The contractor shall submit the interim bills to consultants in triplicate with complete detailed measurements for scrutiny and approval. The consultant after scrutiny of the bill shall send one copy to owner for payment and other copy to the contractor for his record.

The contractor shall be solely responsible for correct recording of the measurement of the items & get them checked by consultants before covering the hidden items.

40. SETTLEMENT OF DISPUTES

In case of any dispute or difference arising between the parties (Contractor and Owner) out of Contract which cannot be amicably settled, shall be finally settled under the provisions of the Arbitration Act. 1940 and rules made there under as amended from time to time. The venue of Arbitration shall be at Karachi.

41. MISCELLANEOUS

Within the ambit of this Contract and to further its execution, the Owner may issue directions from time to time which will be binding upon the Contractor.

42. CONTRACTOR TO PROVIDE EVERY THING

The Contractor is to provide everything of every sort and kind which may be necessary and requisite for the proper execution of the works included in the contract whether original or altered according to the intent and meaning of the drawings and specification taken together, which are to be signed by the Owner and the contractor whether the same may or may not be particularly described in the specification or shown in the drawings provided that the same are reasonably to be inferred there-from and in case of any discrepancy between the drawings and the specifications the Owner is to decide which shall be followed. The contractor shall also provide all necessary fencing and lights required to protect the public from accident, & shall be bound to bear the expenses of defence of every suit, action or other proceedings at law that may be brought by any person for injury sustained owing to neglect of the above precautions, and to any damages and cost which may be awarded in any such suit, action or proceedings to any such person or which may with the consent of the Contractor be paid to compromise any claim by any such person.

43. ESCALATION

a). No escalation shall be entertained on any item during first year of project.

b) No Escalation / Claim on account of fluctuations of rates shall be entertained during the currency of Contract against any item under Schedule of Rates involved in Construction of Work, unless announced (on Items) by the Govt. of Sindh after Award of Work but within contract period on "Schedule of Rates Items" only.

b). Non-Schedule Rate Items.

Escalation / claim on account of fluctuations of rates will be paid during the currency of Contract on Non-Schedule items.

The following basic rates shall be considered for calculating the escalation of the following item (Ex-factory).

O.P Cement	Rs.15,000/- Per Tonne
S.R. Cement	Rs.15,600/- Per Tonne
Steel All Diameters	Rs.190,500/- Per Tonne.

Difference in cost (+ / -) will be paid only for material consumed as per R.A bill.

- c). No Escalation will be entertained on Schedule / Non-Schedule items after expiry of date of completion of project as envisaged in Contract unless the extension is granted due to conditions of force majeure or certain delays beyond the control of Contractor.
44. KEEP FOUNDATIONS AND WORKS FREE FROM WATER
If necessary, the Contractor shall provide and maintain power driven pumps to keep the works free from water. The water shall be disposed to the satisfaction of the local authorities and / or the Consultants.
45. WATER / POWER FOR CONSTRUCTION PURPOSES
The Contractor shall make at his own cost arrangements for water / power and shall have to lay his own distribution system to place where water / power is required. Contractor shall allow free use of water / power to his sub-contractors. If available the Owner may supply power @ 0.75% of the Contract amount and 2% for water of the contract amount for this service.
46. BAR BENDING SCHEDULE (FOR CIVIL WORKS CONTRACTOR ONLY)
The Contractor shall prepare bar bending schedule for commencing the work of cutting, bending and binding of the steel reinforcement of any structural member for approval of consultants and for recording in measurement book.
47. AS BUILD DRAWING (FOR CIVIL CONTRACTORS ONLY)
After the completion of the project the following as build drawings should be submitted to the CONSULTANTS for submission to the Owner. (To whom and where applicable)
i. Complete Architectural Plans.
ii. Plumbing / Drainage Layout Plans.
iii. Electrical Installations.
In service drawings all sizes and routing of pipes, cables and wires should be clearly indicated in different colours.
48. TERMS OF PAYMENTS
- a) **Mobilization Advance**
- (1) Mobilization Advance upto 10% of the Contract Price stated in the Letter of Acceptance shall be paid by the Procuring Agency to the Contractor on the works costing Rs. 2.5 Million or above on following conditions:
- On submission by the Contractor of a Mobilization advance Guarantee for the full amount of the Advance in the specified form from a Scheduled Bank in Pakistan to the Procuring Agency;
 - Contractor will pay interest on the Mobilization Advance at the rate of 10% per annum on the advance; and

- This Advance including the interest shall be recovered in 5 equal installments from the five (05) R.A bills and in case the number of bills is less than five (05) then $1/5^{\text{th}}$ of the advance **inclusive of the interest** thereon shall be recovered from each bill and the balance together with interest be recovered from the final bill. It may be incurred that there is sufficient amount in the final bill to enable recovery of the Mobilization Advance.

OR

(2) **Secured Advance on Materials**

- The Contractor shall be entitled to receive from the Procuring Agency Secured Advance against an INDENTURE BOND in P.W Account Form No. 31 (Fin. R. Form No. 2 acceptable to the Procuring Agency of such sum as the Engineer may consider proper in respect of non-perishable materials brought at the Site but not yet incorporated in the Permanent Works provided that:
 - The materials are in accordance with the Specifications for the Permanent Works.
 - Such materials have been delivered to the Site and are properly stored and protected against loss or damage or deterioration to the satisfaction and verification of the Engineer but at the risk and cost of the Contractor.
 - The Contractor's records of the requirements, orders, receipts and use of materials are kept in a form approved by the Engineer, and such records shall be available for inspection by the Engineer:
 - The Contractor shall submit with his monthly statement the estimated value of the materials on Site together with such documents as may be required by the Engineer for the purpose of valuation of materials and providing evidence of ownership and payment therefore:
 - Ownership of such materials shall be deemed to vest in the Procuring Agency and these materials shall not be removed from the Site or otherwise disposed of without written permission of the Procuring Agency:
 - The sum payable for such materials on Site shall not exceed 75% of the (i) landed cost of imported materials, or (ii) ex-factory / ex-warehouse price of locally manufactured or produced materials, or (iii) market price of stands other materials;
 - Secured Advance should not be allowed unless & until the previous advance, if an, fully recovered;
 - Detailed account of advances must be kept in part II of running account bill; and

- Secured Advance may be permitted only against materials / quantities anticipated to be consumed / utilized on the work within a period of 3 months from the date of issue of secured advance and definitely not for full quantities of materials for the entire work / contract.
 - Recovery of Secured Advance
 - Secured Advance paid to the Contractor under the above provisions shall be effected from the monthly payments on actual consumption basis, but not later than period specified in the usles and more than three months (even if unutilized). Other conditions.
 - As recoveries are made the outstanding accounts of the items concerned in Part – II should be reduced to making deduction entries in the column, - -- deduct quantity utilized in work measured since previous bill, equivalent to the quantities of materials used by the Contractor on items of work shown as executed in Part 1 of the bill.
 - Interim Payments. The Contractor shall submit to the Engineer monthly statements of the estimated value of the work completed less the cumulative amount certified previously.
 - The value of work completed comprises the value of the quantities of the items in the Bill of Quantities completed.
 - Value of secured advance on the materials and valuations of variations (if any).
 - Engineer may exclude any item certified in a previous or reduce the proportion of any item previously certified in any certificate in the light of later information.
- (v) Retention money and other advances are to be recovered from the bill submitted by Contractor.

SECTION – 5

SPECIAL STIPULATIONS AND FORMS

SPECIAL STIPULATIONS

The Stipulations outlined hereunder in the form of a Table summarize certain terms and conditions which are set forth in the Instructions to Tenderers and Conditions of Contract and these Stipulations form an integral part of the Contract.

1	Works	CONSTRUCTION OF HOSTEL FOR MALE POST GRADUATE STUDENTS
2	Owner	LUMHS, Jamshoro, Sindh.
3	Owner's Representative	PROJECT MANAGEMENT UNIT LUMHS, Jamshoro, Sindh.
4	Earnest Money	5% of the Tender Price of work in the Shape of Pay order / Demand Draft issued by a Scheduled Bank of Pakistan in Favour of Vice Chancellor, LUMHS, Jamshoro, Sindh.
5	Time for commencement	Within Seven (7) days from the date of receipt of Owner's letter of Award.
6	Time for furnishing the programme	Within Ten (10) days from the date of receipt of letter of Award
7	Time of completion	15 Months from the date of receipt of Owner's Letter of Award.
8	Defects liability period	365 days from the effective date of taking over / completion certificate whichever is later.
9	a). Amount of liquidated damages	Rs. 0.05% (Point Zero Five Percent) of contract value for each day of delay in Commencement / Completion of the works subject to a maximum of 10 % of contract price stated in the Letter of Award.
	b). Payment to be made to Consultants	As per Clause 15 Page-10 of instructions to the tenderers

11	Limit of Retention Money	5 % of Final cost of the Project. a). 50% amount will be released after issuance of completion certificate of substantial completion of works by the Consultants. b). 50% amount will be released after completion of Defects Liability Period and handing over the site by the Contractor and taken over by the Owners in writing.
12	Minimum amount of interim Payment Certificate (Running Bill)	1/10 th portion of total work
13	Time required to enter into and execute the Agreement.	14 (Fourteen) days from date of Award of Work.
14	Escalation in the cost of Material and Labour	All as per Clause 43 Page 29 of special conditions of contract.
15	Time of interim payment	Within 30 days from the date of delivery of consultant's certificate to the Owner.
16	Income Tax Deduction	As per Law of Pakistan.
17	Performance Bond	To be obtained from approved Bank for a sum equivalent to 5% of Contract Price stated in the Letter of Award for the whole completion period and also for Defect Liability Period. (No. RA Bill will be processed until the Bond is submitted).
18	Insurance cover for works	It shall be a Contractor All Risk Policy and workmen's compensation policy to cover an amount equal to full contract value and cost of equipment, the labour employed by the Contractor as well as the Owner, visitors and guests. Insurance cover will be arranged by the Contractor from Insurance Company, approved by the owner and should be submitted within 30 days from the date of Owner's Letter of Award. (No. RA Bill will be processed until C.A.R Policy is submitted).

- 19 Minimum Amount of Third Party Insurance Rs. 10,00,000/- (Rupees One Million)
- 20 Mobilization Advance Upto 10% (Ten Percent) of the Contract amount, payable to the Contractor against irrevocable guarantee from a schedule bank approved by Owner after execution of the agreement and all other bonds.
- 21 Secured Advance
- OR
- Secured advance may be paid against non-perishable items delivered at site (No secured Advance will be paid for cement being perishable item)

ACCEPTED

Contractor's Signature
With Stamp & Date

SECTION – 6

FORMS OF AGREEMENT / PERFORMANCE BOND /
MOBILIZATION ADVANCE / INTEGRITY PACT

AGREEMENT OF WORK

THIS AGREEMENT is made at Karachi on the _____ day of _____ 20-____ between THE PROJECT _____ COORDINATOR, LUMHS, JAMSHORO, SINDH (hereinafter called the OWNER) of the ONE PART.

and

M/S _____ having registered office at _____ (hereinafter called "Contractor") of the OTHER PART.

Whereas the OWNER is desirous that certain WORKS viz; **CONSTRUCTION OF HOSTEL FOR MALE POST GRADUATE STUDENTS** should be carried and has accepted a Tender by the Contractor for the construction, completion and maintenance of the works.

NOW THIS AGREEMENT WITNESSETH AS FOLLOWS;

1. In this Agreement, words and expressions shall have the same meanings as are respectively assigned to them in the Conditions of Contract hereinafter referred to.
2. The following documents shall be deemed to form and be read and construed as part of this Agreement, viz;
 - a. Tender Notice.
 - b. Instructions to Tenders.
 - c. Special Conditions of Contract.
 - d. Special Stipulations.
 - e. Addenda & Corrigenda, if any, issued by the Owner and duly accepted by the Contractor at the signing of the Contract.
 - f. Earnest Money
 - g. Form of Tender.
 - h. Letter of Award by the Owner
 - i. Form of Agreement / Contract Agreement.
 - j. Owner's Order to Commence the Works.
 - k. Performance Bond
 - l. Contractors All Risk (C.A.R) Policy
 - m. Third Party Insurance
 - n. Other Insurance required as per Contract
 - o. Limit of Retention Money
 - p. Any correspondence by the Owner / Contractor mutually accepted by the Owner and Contractor
 - q. Technical Specifications
 - r. Bill of Quantities
 - s. Detailed Working Drawings.

3. In consideration of the convenience and agreement to be kept and performed by the Contractor, and for the faithful performance of this contract and the completion of the works embraced therein, according to the specifications and conditions herein contained and referred to or agreed to in the course of subsequent negotiations and in accordance with the "General Conditions of Contracts" the owner shall pay and the contractor shall received full compensation for everything furnished and done by the contractor under this agreement, the contract price stipulated in the Contractor's tender, or such other sum as may be ascertained in accordance with such conditions of contract, etc, and rates quoted against each item of work and agreed to and accepted by the parties as one instrument and at the times in the manner prescribed by the conditions of contract.
4. The contractor, at his own proper cost and expense shall do all work and furnish all labour, materials, supplies, water & power, tools, machinery and other equipment and constructional plant that may be necessary for the execution of the work.
5. The maintenance of a rate of progress in the work which will result in its completion within the specified time, is an essential feature of this contract and the contractor agrees to proceed with all due diligence and care at all times and take all precautions to ensure the time of completion as defined herein, time being deemed to be the essence of the contract on the part of the Contractor.
6. The said works shall be started within 7 (Seven) days of the issue of Letter of Award from the Owner to the Contractor to proceed with the works, and the Contract shall be duly completed on or before _____
7. The Contract documents (Including any addenda thereto) consisting of the Instructions to Tenderers, the Tender for works, General Conditions of Contract, Special Provisions and Stipulations, Bill Of Quantities & rates Technical Specifications, Drawings, Performance Bond, Construction Schedule submitted by the Contractor, Letters of Award, forming part of this contract, are each and all made a part hereof, and have the same force and effect as if set forth at length herein.
8. The Owner shall deduct and retain an amount equal to 5% (Five Percent) of the amount payable to the Contractor under each "On Account" bill submitted by the Contractor as security deposit for the due and faithful discharge by the Contractor of his obligations under this agreement. The sum of such security deposit will be refundable to the Contractor after the successful completion and acceptance of works on expiry of twelve months of the maintenance period in a manner indicated in special stipulations. Income Tax will be deducted from every bill submitted by the Contractor as per Law of Pakistan.

9. That this contract agreement shall be executed in four original signed copies, three copies where of shall be filed in the office of the Owner and one given to the Contractor.

10. The owner shall make all possible efforts to pay off the running bills on account of work done, submitted by the Contractor as early as possible.

IN WITNESS WHEREOF, the Owner and the Contractor have executed this Agreement on the day and year mentioned above.

FOR AND ON BEHALF OF
CONTRACTOR

PROJECT MANAGER /
PROJECT COORDINATOR, LUMHS,
JAMSHORO, SINDH.
(OWNER)

(SEAL)

(SEAL)

Signed and delivered by the
Contractor above named in
the presence of :

Signed and delivered by the
Owner above named in the
presence of :

WITNESS:

WITNESS:

1. _____

1. _____

2. _____

2. _____

To,

PERFORMANCE BOND

WHEREAS

(hereinafter called the Contractor) of the one part by an agreement made between The Project Manager / Project Coordinator, LUMHS, Jamshoro, Sindh (hereinafter called the Owner) of the other part, has entered into a Contract (hereinafter called the Contract) for the construction, completion and maintenance in conformity with the provision of the Contract works viz

AND WHEREAS in accordance with the provision of the Contract, the Contractor is required to furnish a Performance Bond for the due performance and observance of all the terms, provision and stipulations of the Contract by the Contractor & the Contractor has requested us _____ to issue the said Bond for an amount of Rs. _____ (Rupees _____ only) equivalent to 5% (Five Percent) of the Contract price.

In consideration of the premises, we _____ scheduled bank _____ hereby guarantee irrecoverably and unconditionally forthwith to pay to the owner without any reference to the Contractor on the Owner's first demand in writing stating that the Contractor has committed a default under the Contract without any further statement of the particulars of such default and notwithstanding any contestation by the Contractor an amount not exceeding Rs. _____ (Rupees _____ only) limited do hereby further declare that no alternation in the terms of the Contract made by agreement between the Owner and the contractor or in the

extent or nature of works to be constructed, completed and maintained therein and no allowance of time by the Owner or the consultant under the Contract not forbearance of forgiveness in or in respect of any matter or thing concerning the Contract on the part of the Owner or the said consultant shall in any way release this _____ scheduled bank from any liability under this Bond.

This Bond shall remain valid & in force upto the completion works and completion of maintenance period and any demand for payment made by the Owner before the date of expiry of this Bond shall be paid forthwith by this _____ scheduled bank to the Owner.

Signed and delivered by the Contractor

Above named in the presence of

1 _____

2 _____

(CONTRACTOR)

Date: _____

Signed and delivered by the
Surety above named in the
presence of

1 _____

2 _____

(SURETY)

Date: _____

MOBILIZATION ADVANCE BANK GUARANTEE FORM

To,

Sir,

We understand that you have entered into Contract with:

Messrs

(Full Name and Address)

(hereinafter reference to as our Customer) and that one of the conditions of the Contract is submission of Bank Guarantee in the sum of _____ against Mobilization Advance and at the request of Customer and in consideration therefore, we hereby agree and undertake as under:

1. To pay to you on demand unconditionally and without any question and without any reference to our Customer an amount not exceeding the sum of Rupees _____

—

(in words)

As mentioned in your written demand notice in case of failure of M/s _____ to fulfill their obligation including non-completion of project within _____ months

2. We hereby guarantee to pay the full amount of this guarantee (as indicated herein above) to be beneficiary if the Contractor.
 - a. Fails to utilize the amount of Mobilization advance for the purpose agreed / indicated in the Contract.
 - b. Fails to repay and or adjust the advance by _____ irrespective of any reason.

3. In case beneficiary decides not to encash the guarantee under para 2 (b) above we guarantee to pay the interest @ _____ % month to beneficiary on the balance amount of advance outstanding against our customer till the full amount is recovered.
4. The validity period of this guarantee is upto _____ (date) unless otherwise extended by us, or when its value has been reduced to nil, or upon presentation of a copy of the Certificate with Clause _____ of the agreement, whichever is the sooner.
5. Claims, if any must be duly received by us on or before the validity date. Our liability under this guarantee will cease upon the close of banking business hours on this date. Claims received thereafter will not be entertained by us whether or not you have suffered and loss. On receipt of payment under this guarantee, this guarantee must be duly cancelled, discharged and returned to us.
6. We _____ (Bank) further agree and declare that the beneficiary shall have the fullest liberty without our consent or prior approval and without affecting in any manner our obligations, to vary and of the terms and conditions of the said agreement or to extend time of its performance by the said contractor(s) from time to time or to postpone for any time or from time to time any of the powers exercisable by the beneficiary against the contractor(s) and to forbear or enforce any of the terms and conditions relating to the said agreement and be it expressly declared that notwithstanding and such variations or extension being granted to the contractor(s) by the beneficiary of the beneficiary in favour of the contractor(s), the contractor(s) shall not be relieved of their liability by reason of such variation, extension or acts of forbearance.
7. In order to give full effect to the guarantee herein contained, our liability shall not be discharged or account of beneficiary forbearance, variation, extension nor shall we claim any rights or surety ship in respect of any security which you might be having in respect of the said agreement.

8. The maximum liability under this guarantee will be reduced equal to the amount recovered by the beneficiary through the contractors running bills
9. This guarantee, within the validity period shall not be affected by any change in the constitution of the contractor or us nor shall it be affected by any change in beneficiary constitution.
10. The guarantee shall come into force upon receipt by M/s _____ of the Mobilization advance.
11. This guarantee shall not be revocable by us except with beneficiary previous consent in writing.
12. It shall not be necessary for beneficiary to proceed against the contractor before proceeding against us and the guarantee herein contained shall be enforceable against us notwithstanding any security which beneficiary may have obtained or obtain from contractor(s) at any time or when proceedings are taken against us.
13. We certify that our bank is a scheduled bank.

Guarantor

(_____ Bank Limited.)
Bank seal and signature

Contractor:

The signature should be of the same person who had signed the Contract.

WITNESS:

1 _____

2 _____

Full Name, Address and
N.I.C. No. of the Bank Official.

INDENTURE FOR SECURED ADVANCES.

(For use in cases in which is contract is for finished work and the contractor has entered into an agreement for the execution of a certain specified quantity of work in a given time).

This INDENTURE made the _____ day of _____ 20___. BETWEEN (hereinafter called "the Contractor" which expression shall where the contract so admits or implied be deemed to include his heirs, executors, administrators and assigns) of the one part and THE GOVERNOR OF SINDH (hereinafter called " the Government" of the other part).

WHEREAS by an agreement, dated _____ (hereinafter called the said agreement, the contractor has agreed to perform the under mentioned works (hereinafter referred to as the said work): -

(Here enter (the description of the work).

AND WHEREAS the contractor has applied to the _____ for an advance to him of Rupees _____. (Rs. _____) on the security of materials absolutely belonging to him and brought by him to the site of the said works the subject of the said agreement for use in the construction of such of the said works as he has undertaken to execute at rates fixed for the finished work (inclusive of the cost of materials and labour and other charge) AND

WHEREAS the Government has agreed to advance to the Contractor the sum Rupees, (Rs. _____) on the security of materials the quantities and other particulars of which are detailed in Part II of Running Account Bill (E). the said works signed by the contractor (*Fin R. Form 17.A*) on _____ and on such covenants and conditions as are hereinafter contained and the Government has reserved to itself the option of marking any further advance or advances on the security of other materials brought by the Contractor to the site of the said works.

NOW THIS INDENTURE WITNESSETH that in pursuance of the said agreement and in consideration of the sum of Rupees _____ (Rs. _____) on or before the execution of these presents paid to the Contractor by the Government (the receipt whereof the Contractor doth hereby acknowledge) and of such further advances (if any) as may be made to him as aforesaid (all of which advances are hereinafter collectively referred to as the said amount) the Contractor doth hereby assign upto the Government the said materials by way of security for the said amount.

And doth hereby covenant and agree with the Government and declare by follow:

- That the said sum of Rupees _____ (Rs. _____) so advanced by the Government to the Contractor as aforesaid and all or any further sum or sums which may be advanced aforesaid shall be employed by the contractor in or towards expending the execution of the said works and for no other purpose whatsoever.
- That the materials detailed in the said Running Account Bill (B) which have been (*Fin R. Form No. 17.A*) offered to and accepted by the Government as security for the said amount are absolutely by the Contractor's own property free from encumbrances of any kind and the Contractor will not make any application for or receive a further advance on the security of materials which are not absolutely his own property and free from encumbrances of any kind and the Contractor hereby agrees, at all times, to indemnify and save harmless the Government against all claims whatsoever to any materials in respect of which an advance has been made to him as aforesaid.
- That the said materials detailed in the said Running Account Bill (B) and all other Materials on the security of which any further advance or advances may hereafter be made as aforesaid (hereinafter called the said materials) shall be used by the Contractor solely in the execution of the said works in accordance with the directions of the Divisional Officer _____ (hereinafter called the Divisional Officer) and in the terms of the said agreement.
- That the Contractor shall make at his own all necessary and adequate arrangement for the proper watch, safe custody and protection against all risks of the said material and that until used in construction as aforesaid the said materials shall remain at the site of the said works in the Contractor's custody and at his own risk and on his own responsibility and shall at all times be open to inspection by (the Divisional Officer or any Officer authorized by him. In the event of the said materials of any part (hereof being stolen, destroyed or damaged or becoming deteriorated in a greater degree than is due to reasonable use and wear thereof Contractor will forthwith replace the same with other materials of like quality or repair and make good the same as required by the Divisional Officer and the materials so brought to replace the said materials so repaired and made good shall also be considered as security for the said amount.
- That the said materials shall not on any account be removed from the site of the said works except with the written permission of the Divisional Officer or an officer authorized by him in that behalf.

- That the said amount shall be payable in full when or before the Contractor receives payment, from the Government of the price payable to him for the said works under the terms and provisions of the said

agreement PROVIDED THAT if any intermediate payments are made to the contractor on account of work done then on the occasion of each such payment the Government will be at liberty to make a recovery from the Contractors Bill for such payment by deducting there from in the value of the said materials (then actually used in the construction and in respect of which recovery has not been made previously the value for this purpose being determined in respect of each description of material at the rates at which the amount of the advances made under these presents were calculated.

- That if the Contractor shall at any time make any default in the performance or observation in any respect of any of the terms and provisions of the said agreement or of these presents the total amount of the advance or advances that may still be owing to the Government shall immediately on the happening of such default be repayable by the Contractor to the Government together with interest thereon at twelve percent per annum from the date or respective dates of such advance or advances to the date of repayment and with all costs, charges, damages and expenses incurred by the Government in or for the recovery thereof or the enforcement of this security or otherwise by reason of the default of the Contractor and any money so becoming due and payable shall constitute a debt due from the Contractor to the Government and the Contractor hereby covenants and agrees with the Government to repay and the same respectively to it accordingly.
- That the Contractor hereby charges all the said materials with the repayment to the Government of the said sum of Rupees: _____ (Rs. _____) and any further sum or sums which may be advanced as aforesaid and all costs charges damages and expenses payable under these presents PROVIDED ALWAYS and it is hereby agreed and declared that notwithstanding anything in the said agreement and without prejudice to the powers contained therein if and whether the covenant for payment and repayment hereinbefore contained shall become enforceable and the money owing shall not be paid to accordingly.

Once there with the Government may at any time thereafter adopt all or any of following courses as it may deem best: -

- Seize and utilize the said materials or any part thereof in the completion of the said works on behalf of the Contractor in accordance with the provisions in that behalf contained in the said agreement debiting the Contractor with the actual cost of effecting such completion the amount due in respect of advances under these presents and crediting the Contractor with the value of work done as he had carried it out in

accordance with the said agreement and at the rates thereby provided. If the balance is against the Contractor he is to pay the same to the Government on demand.

- Remove and sell by public auction the seized materials or any part thereof and out of the moneys arising from the sale retain all the sums aforesaid repayable to the Government under these present and pay over the surplus (if any) to the Contractor.
- Deduct all or any part of the moneys owing out of the security deposit or any sum due to the Contractor under the said agreement.

That except as is expressly provided by the presents interest on the said advance shall not be payable.

That in the event of any conflict between the provisions of these presents and the said agreement the provisions of these presents shall prevail and in the event of any dispute or difference arising over the construction or effect of these presents the settlement of which has not been hereinbefore expressly provided for the same shall be referred to the Superintending Engineer _____ Circle whose _____ decision shall be final and the provisions of the Indian Arbitration Act for the time being in force so far as they are applicable shall apply to any such reference.

In witnesses whereof the * _____ on behalf of the Governor of Sindh and the said _____ have hereunto set their respective hands and seals the day and first above written.

Signed sealed and delivered by* in the presence of

Seal

1st witness 2nd witness

Signed sealed and delivered by* in the presence of

Seal

1st witness 2nd witness

SECTION – 7

TECHNICAL SPECIFICATION

SECTION – I

TECHNICAL SPECIFICATIONS

CIVIL WORK

SCOPE OF WORK

The work covered by this section of the specifications consists of furnishing all plant, labour, equipment, appliances and materials and in performing all operations in connection with excavating filling and backfilling for building construction and other foundation complete in strict accordance with the applicable drawings and subject to the terms and conditions.

1 (a) – EXCAVATION AND BACK FILLING

As specified in the Bill of Quantities.

1. (b) - DISPOSAL OF SURPLUS EARTH AND RUBBISH

All surplus earth and rubbish shall be disposed off by the Contractor at his cost as directed by the Consultants. The terms of disposal shall include all operations of loading, unloading, stacking, spreading filling depressions, consolidating & ramming in layers not exceeding 12" (300 mm) thickness.

2 CONCRETE WORK

SCOPE OF WORK

The work covered by this section of the specifications consists of furnishing all labour, equipment, appliances and materials and in performing all operations in connection with concrete work complete in strict accordance with the applicable drawing and the specifications set here in and subject to the terms and conditions of the contract.

Electrical / Mechanical poker vibrator of suitable diameter shall be used for vibrating all concrete specially R.C.C. works.

a) Full cooperation shall be extended to other trades to install embedded items. Embedded items will be inspected and tests for concrete and other materials or for mechanical operations will be completed and approved before concrete is placed.

b) MATERIALS

i) WATER

Only clean water from the city supply, tube well installed at the site or from other sources approved by the Engineer In-charge shall be used in mixing concrete, Curing, Cleaning plant and tools. The water shall be tested according to B.S. 3148. When its suitability is doubtful.

The Engineer In-charge may refuse to permit water containing any sugar, excess, acid alkali or salt. As a guide the following concentrations represent the maximum permissible values:

- i. To neutralize 260 ml sample it should be required more than 2 ml of 0.1 normal NaOH.
- ii. To neutralize 200 ml sample it should not required more than 10 ml of 0.1 normal HCL.
- iii. Percentage of solids should not exceed the following.

*	Percentage
Organic	0.02
Inorganic	0.30
Sulphates	0.50
Alkali chlorides	0.10

Table 4.3

In case of doubt the Engineer In-charge may require that concrete mixed with water proposed to be used should not have a compressive strength lower then 90% of the strength of concrete.

ii) CEMENT:

In all the R.C.C. structure, sulphate resisting cement shall be used upto plinth level. (If Specified in Structural drawings).

In super structure ordinary grey Portland cement (local) shall be used. Use of imported cement is totally forbidden unless approved by the CONSULTANTS.

- iii) The Contractor shall provide at his own cost on the site all necessary sheds which shall be perfectly dry and water tight for the storing of cement to be delivered to the works to ensure adequate supplies being available for site work.
- iv) If at any time the Consultants consider that any batch of cement may have deteriorated on site during storage of any reason he will direct that tests shall be made and the batch of cement on the site which may be in question, shall not be used until it has been shown by test to be satisfactory. Any rejected cement shall be removed from the site by the Contractor without delay. Cement reclaimed from cleaning bags or leaking containers shall not be used.
- v) Cement shall be consumed in the sequence of receipt of shipment unless otherwise directed by the Consultants.

c) AGGREGATES

- i. All fine and coarse aggregate to be used shall be supplied from approved source which shall not be changed without permission in writing from the Consultants. Aggregate shall conform to the test requirements of B.S. No. 812 or equivalent ASTM or Pakistan Standard 243:1963.
- ii. Fine aggregate shall be approved sand to be obtained from approved source and shall be clean sharp, free from clay, earth, vegetable and organic matters, alkaline or acid reactions or other deleterious matter or impurities.

- iii. Fine aggregates shall conform to British Standard specifications B.S. No. 882 and shall be graded as follows:

B.S. Sieve		Percentage (weight) Passing	
No.	(Grading Zone -1)	(Grading Zone - 2)	
3/8" (10mm)	100	100	
3/16" (5mm)	90 – 100	90 – 00	
No. 7	60 – 110	75 – 100	
No. 14	30 – 70	55 – 90	
No. 25	15 – 34	35 – 59	
No. 52	5 – 20	8 – 30	
No. 100	0 – 10	0 – 10	

- iv. Locally available Coarse aggregate shall be crushed stone and shall be clean free from sand, dust, salt, lime, chalk, clay, organic impurities or other deleterious matter.
- v. Coarse aggregate shall conform to the relevant British Standard specifications or ASTM Standard.
- vi. If required, aggregate shall be washed and screened to the satisfaction of the Consultants before use by making proper screening and washing.
- vii. Sieve analysis and other necessary tests of all aggregates shall be carried out as and when required by the Consultants. Sample for such tests shall be taken in the presence of the Consultants.
- viii. All costs in connection with the tests shall be borne by the Contractor.
- ix. All aggregates shall be subject to the approval of the Consultants. Any aggregates not found to the required standard shall be rejected by the Consultants and shall have to be removed from site without any delay. Concrete structures executed with rejected aggregates shall be dismantled and rebuilt at the contractor's expense.

3. CLASSIFICATION OF CONCRETE

Classes of concrete to be used in various parts of the works shall be indicated on the drawings and concrete of various grades shall be proportioned as set out in Table-1 appended hereto.

Table-1 showing minimum required compressive strengths of 6 in. x 6 in. x 6 in. (150 x 150 x 150 mm) cubes and minimum quantity of cement required per 100 cubic feet of finished concrete for various mixes and under various conditions.

Class of Concrete	Nominal Mix-Ratio	Min.Qnty Bags per % cft.	Preliminary test Cubes strength.		Work test Cube strength.	
			p.s.i at 7 days	p.s.i at 28 days	p.s.i at 7 days	p.s.i at 28 days
A	1:1:2	30	4000	6000	3000	4500
B	1:1-1/2:3	24	3300	5000	2500	3750
C	1 : 2 : 4	17	2660	4000	2000	3000
D	1 : 3 : 6	13.5	1330	2000	1000	1500
E	1 : 4 : 8	10.0	900	1350	660	1000

The Mix-Ratio indicated in above table are only as guide line normally these ratios achieve the required strength but may vary due to quality of aggregates available in the area of work. The structural design is based on cube strength after 28 days. Therefore the strength should be achieved by design of mix.

To achieve the required strength is the sole responsibility of the Contractor. No Admixture is recommended for use in concrete for getting the required strength, if any Admixture is recommended by the Laboratory it may be used after approval from The Consultants at the entire RISK AND COST of the Contractor. No extra payment will be made in this regard even if the Admixture is approved by the Consultant.

4. PROPORTIONING OF CONCRETE MIXES

All concrete shall be proportioned by volume unless specifically allowed by Consultants. This proportions given in Table-1 above are suitable only when the specific gravities of the aggregate are in the region of 2.5.

The Contractor shall submit to the consultant proposed mix designs for concrete to be used, based on preliminary laboratory test to determine proportion of cement, aggregate and water in the concrete conforming to the quality and strength requirement specified herein Preliminary test results of at least three different mixes of each class of concrete with varied water cement ratio shall be submitted. The results of 7 days and 28 days cube tests shall be used to establish the ration between 7 days and 28 days strengths.

The consultants may make adjustments in the mix for a certain work. Preliminary design of mixes and testing shall be a responsibility of the contractor. The proportions voids in the aggregate shall be controlled and if it exceeds 45%, sand and consequently the cement shall be increased by the contractor without any charge. If the proportion is less than 40%, sand shall be decreased but not the cement.

5. WATER CEMENT RATIO

5.1 SLUMP TEST

A test of the plasticity and flow ability of concrete should be made in the field in presence of Representative of Owner during every concrete operation. The slump cone is a sheet metal (or frustum of a cone) 12" high, 4" in diameter at the top and 8" in diameter at the bottom. After the mixer is fully emptied of a batch, the cone is filled in three layers, roding each layer 25 times with a 5/8" dia bullet pointed rod. The cone is then lifted and the slump is measured. The height of the pile will be less than 12". The allowable slump is generally defined in specifications.

5.2 MAXIMUM ALLOWABLE WATER CONTENT

All concrete specimens shall be made, cured and tested in accordance with British Standard or ASTM Standard. A curve representing the relation between the water content and the average 28 days compressive strength earlier strength at which the concrete is to receive its full working load shall be established for a range of value including all the compressive strength shown on the Plans. The curve shall be established by at least four points, each point representing average values for at least four test specimens. The maximum allowable water content for the concrete shall be as determined from this curve and shall correspond to a strength 15% greater than indicated on the plans. The slump for concrete shall be minimum of 1" (25mm) and a maximum of 2-1/2" (75 mm) provided the requisite strength is obtained. Corrective additions to remedy deficiencies in aggregate gradations shall be used only with the written approval of the Consultants. When such permissions are permitted the material shall be measured separately for each batch of concrete.

6. SAMPLES AND TESTING

a. GENERAL

Test cubes concrete shall be provided and stored by the Contractor as and when directed by the Consultants. Test cubes shall be tested by the approved laboratory and the contractor shall bear the charges for the same.

b. Cement shall be tested as prescribed in British Standard or ASTM Standard, at the cost of Contractor.

c. AGGREGATES

Aggregates shall be tested at Contractor's cost as prescribed in British Standard 812. In additions, fine aggregates shall be tested for organic impurities in conformity with B.S. 812 or equal ASTM Standard.

d. TESTING OF CONCRETE

i. All test cubes shall be 6 x 6 x 6 inch (150 x 150 x 150 mm) size.

ii. Specimens shall be cured under laboratory conditions except that the Consultants may require curing under field conditions.

iii. Three cubes of the set shall be tested at 7 (seven) days and 3 (three) shall be tested at 28 days or at such ages as directed by the Consultants.

iv. All cube moulds shall be steel moulds perfectly true having all internal and the meeting faces machined to smooth surface as approved by the Consultants.

v. If the strength tests of the laboratory controlled specimens for any portion of the work falls below the minimum allowable compressive strength at 28 days required for the class of concrete used in that portion the consultants shall have the right to order replacement of the affected work.

e. PLACING CONCRETE

- i. All concrete shall be thoroughly compacted and consolidated by means of pneumatic mechanical or electrical vibrators or other approved compacting method. Care shall be taken to avoid segregation due to excessive vibration and placing / dropping of concrete from a height of more than 7'-0". The contractor shall maintain on site at all times one or more stand-by vibrators.
- ii. Compaction shall be done until the whole mass assumes a jelly like appearance and consistency, with the water just appearing on the surface. Concrete shall be sufficiently tamped and consolidated around the steel rods, care be taken that the vibrator does not as such touch steel or form work.
- iii. Hardened concrete, debris and foreign materials shall be removed from interior of forms and from inner surface of mixing and conveying equipments.
- iv. Construction joints in concrete shall only be given at location indicated in the drawings or as approved by the Consultants. At the end of the day's work the concrete shall be finished off against a temporary shutter stop which shall be vertical and securely fixed.
- v. Should any part of the exposed surface present a rough uneven or imperfect appearance when shuttering is removed, it shall be picked out to the such depth and refilled and properly resurfaced as per directions of the Consultants.
- vi. Whole work is to be smooth, pleasing and to the entire satisfaction of the Consultants.

7. FORM WORK

48. GENERAL

The form work shall be inclusive of all labour, material, workmanship and alike. All formwork and supports thereto shall be designed by the contractor and relevant drawings shall be submitted to the Consultant for approval before the work is put in hand. Such an approval shall not relieve the contractor for all the obligations of the contract or give rise to any claims.

49. FORM WORK NOT TO INTERFERE AND INJURE WORK.

The form work shall be so designed and arranged as not be unduly interfere with concrete, during its placing, and easy to be removed without injuring the finished concrete edges, clamps, bolts and tie rods shall be used, when permitted and where practicable, in making the form work rigid and in holding it to true position.

50. OPENINGS IN FORM WORK.

Wherever the concreting is required to be carried out within forms of considerable depths, temporary openings in the side of the form shall be provided to facilitate the pouring and consolidation of the concrete. Small temporary openings shall be provided at the bottom of all forms to permit the removal of rubbish etc.

51. OPENINGS IN THE STRUCTURE AND OTHER DETAILS.

Provisions shall be kept in the form work for openings such as recesses, holes, packets, fillets etc. for housing services and other architectural details in the finished concrete or on its surface and edges as shown on drawings or as directed by the Consultants to fix all necessary inserts, dowels pipe, holdfast, etc. as shown on drawings or as directed.

52. JOINTS IN FORM WORK.

All joints in the form work shall be sufficiently water tight to prevent undue leakage or cement slurry from concrete surface not to be exposed in the finished work. The joints in the form work for all concrete surfaces to be exposed in the finished work shall be water tight jointed and perfectly smooth so as not to allow any leakage of the cement slurry from the concrete.

53. TREATMENT AFTER REMOVAL OF FORMS.

All honey combing or other irregularities are to be properly made good upon the removal of the form work and the surface made good to the satisfaction of the Consultants. All such defects must be inspected by the CONSULTANT before carrying out any remedial work.

54. No form work shall be measured and paid for separately and shall be deemed to be included in the units price of Concrete whether cast-in-situ or pre-cast and subsequently fixed in position.

8. CLEARING AND REMOVAL OF RUBBISH

On completion of works herein the contractor shall remove all concrete debris, rubbish, shuttering materials, scraps etc. from the vicinity of the structures completed. All areas shall be cleaned to the satisfaction and approval of the Consultants.

9 REINFORCEMENT STEEL

9.1 SCOPE OF WORK

The work covered by this section of the specifications consists of furnishing all materials, tools, labours and in performing all operations in connection with providing, straightening, cutting, bending, binding and fixing in strict accordance with this section of specifications, the applicable drawings, bar bending schedule, (to be prepared by the CONTRACTOR as per terms and conditions of the contract).

9.2 MATERIALS:

- i). Reinforcing steel to be new billet stock of deformed steel as specified on the drawings and shall conform to British Standard Specifications or equivalent ASTM or Pakistan Standard.

- ii). The Contractor shall furnish to Consultants, Manufacturer's mills certificate to guarantee that steel meets the standard, specifications, requirements and minimum certified yield stresses as follows:

ALL REINFORCEMENT STEEL SHALL CONFORM TO ASTM A-615

YIELD STRENGTH	60,000 Psi
ELONGATION	14 %

10. BRICK MASONRY

10.1 SCOPE OF WORK

The work covered under this section of specifications consists of furnishing all labour, material tools and plants for the satisfactory completion of the works in accordance with the drawings as specified herein and subject to the terms and conditions of the contract.

10.2 GENERAL

Each finished brick shall not be less than 3" x 4½" x 9" in size and shall have a ¼" deep frog on the upper face. All the bricks shall be regular, of homogenous texture uniform in shape and size with sharp and square arises, parallel faces and deep red colour may vary by 1/8" from the standard size. When struck, they should give a clear ringing sound. They shall not absorb more than 1/6th of their weight of water after being soaked for one hour, and shall show no sign of effervescence on drying. A good brick should not break when struck against another brick or when dropped flat from a height of 3'-0" to 4'-0" on the ground. It should have a surface so hard that it cannot be scratched by finger nail. The average compressive strength of five representative bricks shall not be less than 1,800 P.S.I.

10.3 EXECUTION

- a) Unless otherwise specified, bricks shall be laid in English Bond with the frogs upwards. Each brick shall be set with both bed and vertical joints filled with mortar and thoroughly bedded in by tapping with handles of the trowel. No half bricks or bats shall be used except where necessary to complete the Bond. Simple lipping with mortar at the edges shall not be permitted.
- b) All bricks work shall be taken up truly plumb and should be so done with a plumb and straight edge.
- c) Brick work shall be carried up all round at the same height and during construction one part of wall should not be more than 3'-0" higher than any other part.
- d) Brick work constructed shall be of best standard of workmanship obtainable and objectionable offsets in the brick work shall be removed by and at the expense of the contractor.
- e) Each course in the wall after being laid should be properly grouted to fill all of the voids in the area. The grout should be fluid enough to perform this function.

10 PLASTERING.

11.1 SCOPE OF WORK.

The work covered under this section of specifications consist of furnishing all labour, material, tools and plants for the satisfactory completion of the works in accordance with the drawings, as specified herein and the terms and conditions of the Contract.

11.2 MATERIALS.

a) CEMENT

Cement shall be as specified in the section of Plain and Reinforced Cement Concrete.

b) SAND

Sand shall be as specified in the section of concrete work except that the maximum size shall be restricted to that passing a No. 14 sieve for finishing coat and passing a No. 7 sieve for base coat (if any)

c) WATER

Water shall be as specified in the section of Concrete work.

11.3 MORTAR COMPOSITION

a) Mortar for cement plaster shall be mixed in the properties as specified in the Bill of Quantities and shall be applied in one coat or two coats thickness as given in Bill of Quantities and relevant drawings.

11.4 MORTAR BATCHING

a) Methods sand equipment used for mixing mortar shall be such as will accurately determine and control the amount of such separate ingredient entering into mortar.

b) The mortar shall be prepared by mixing the ingredients twice in a dry state, on a pucca platform or in trough and then mixing thoroughly after the addition of water.

c) Mortar shall be mixed only in sufficient quantities for immediate use and all mortar not consumed within 30 minutes after the addition of water to the dry mix shall be rejected and the same will not be allowed to be used. Mixing troughs and pans shall be thoroughly cleaned and washed at the end of each day work.

11.5 PLASTERING

a) The joints of Block Masonry, which in to be plastered, shall have ½" deep grooved join which should be raked before the mortar sets each day.

b) The concrete surfaces to receive plaster shall be properly roughened by dragging with wire brushes while the concrete has not hardened. In case of the hardened concrete, the surface shall be roughened.

c) The surfaces to be plaster shall be kept damp for at least two hours and then treated with cement slurry before plastering.

- d) Level pegs shall be made for all plaster work and shall be got checked from the Engineer at least one day before the plastering work is carried out.
- e) The plaster shall be laid to a true and plumb bob and a straight edge not less than 10 feet in length. All horizontal lines and surfaces shall be tested with a level and all vertical lines and corners with a plumb bob as the work proceeds. The plaster shall be finished perfectly smooth and shall be without wavy surfaces. The edge and corners shall be rounded or chamfered if instructed by the Engineer.

12. GLAZED, MATT FINISH WALL AND FLOOR TILES

12.1 GENERAL

The contractor shall supply and fix tiles as described in B.O.Q.

12.2 LAYING

- i) All tiles should be soaked in water before laying in sufficient quantity to complete a days work.
- ii) All tiles shall be set in bed of cement sand mortar to its correct level and line the mortar shall be evenly spread on the full bottom of tiles.
- iii) Joints shall be grouted with white cement mixed with matching colour of tiles as approved by the Engineer Incharge.

13. PORCELAIN, TERRAZO AND MARBLE TILES

13.1 GENERAL

- a) The contractor shall submit samples of Marble and Porcelain Tiles for flooring and dado required in various locations. The finished floors and dados shall conform in all respects to the characteristics of approved sample by the CONSULTANT / OWNER.
- b) Marble tiles shall be of first quality, free from cracks chips or any other defects and shall be uniform in tone and colour, as selected by Consultant. Marble Tiles be ½” thick, on floors and ¾” thick on steps of staircases where specified.
- c) Marble Tiles in floor, steps and Risers be laid on a layer of pure white cement slurry over cement Concrete Bed.

13.2 LAYING

- i) Immediately prior to laying the tiles will be checked the lot and rejected tiles be replaced.
- ii) All Tiles shall be set in bed of cement / sand mortar to their correct lines and level and the mortar shall be spread evenly on the full bottom of tiles.

iii) All Tiles should be set without joints (Butt joints) as approved by the Consultants.

iv) Marble Tiles be polished and finished with chemical polish.

14. CARPENTRY, JOINERY AND HARDWARE

14.1 SCOPE OF WORK

The work covered by this section of the specifications consists of furnishing all plant, labour, equipment, appliances and materials and in performing all operations in connection with fabrication and installation of shelves, cupboards paneling, doors /

windows frames, shutters etc. as per size, thickness, dimension and details shown on the working drawings, compete schedule of Doors and Windows in strict accordance with this section of the specification and the applicable drawings, finishing schedule, instructions of the Engineer.

14.2 MATERIALS, FITTINGS & SAMPLES

(i) SOFT WOOD

The timber of trees belonging to the botanical group Gymnosperms, commercial timber deodar of this group, with best quality shall be used.

(ii) PLYWOOD

Shall comply in all respects with B.S.S. 1455: 1948. The plywood shall only be obtained from approved manufactures.

The plywood used for doors, paneling and the like shall be of the thickness as specified. The grade shall be first quality. The face and back shall be free from end-joints, dead-knots, overlaps, patches and other defects. Edge joints in veneers shall be well made. Isolated pinworm holes shall be permitted provided they do not run along with plane of the veneer. The face and back shall be free smooth for painting or polishing.

(iii) TEAK VENEER BOARD

Shall be first quality obtained from the manufacture approved by the Engineer / Consultant.

14.3 HARDWARE AND FITTINGS

Hardware and fittings shall be heavy duty hardware of approved quality and manufacture otherwise mentioned in the drawings and Bill of Quantities.

14.4(i) LOCKS AND DOOR CLOSER

Shall be of the best quality available from the approved manufacturers according to the Samples approved by the Consultants.

(ii) HINGES

Shall of best quality (local) heavy duty steel hinges 3" (75 mm) in windows, 4" (100 mm) in single leaf doors and 5" (125 mm) in Main door every leaf should have 4 hinges fixed with steel screws.

(iii) All other fittings shall be best quality available from approved manufacturer. Samples shall be submitted to the consultants, for his approval. Cost of hardware shall be included in item of door and no separate payment will be made.

(iv) HARDWARE-SCHEDULE

Each flush door shutter shall be furnished with the following.

- Best quality (aluminum or bronze) Mortice lock / knobset (local)-1 No.
- Tower-bolts 8" (200 mm) long chromium plated / Aluminum (local)-2 Nos.
Door closers (Japan) of approved Manufacturer where directed by the Engineer-1 No.
- Kick-plates / push plates of stainless steel 6" x 1/8" (150 mm x 3mm) where directed by the Engineer-both sides. All material will be best quality as approved / specified by the owner.

(ii). HINGES

Shall of best quality (local) heavy duty steel hinges 3" (75 mm) in windows. 4" (100 mm) in single leaf doors and 5" (125 mm) in Main door every leaf should have 4 hinges fixed with steel screws.

(iii). All other fittings shall be best quality available from approved manufacturer. Samples shall be submitted to the consultants, for his approval. Cost of hardware shall be included in item of door and no separate payment will be made.

(iv). HARDWARE – SCHEDULE

Each flush door shutter shall be furnished with the following.

- Best quality (aluminum or bronze) Mortice lock / knobset (local) -1 No.
- Tower-bolts 8" (200 mm) long chromium plated / Aluminum (local) -2 Nos.
Door closers (Japan) of approved Manufacturer where director by the Engineer-1 No.
- Kick-plates / push plates of stainless steel 6" x 1/8" (150 mm x 3mm) where directed by the Engineer-both sides. All material will be best quality as approved / specified by the owner of the time of installation.

14.5 WOOD TREATMENTS

In addition to the prior seasoning treatment of timbers, ceilings frame joints, purlins, planks, all the door frames, furring strips blocking grounds, nailing strips in contact with concrete or masonry or wood or other materials, shall first be treated with the pesticides designated in relevant section on Termite control of these specifications and then with solignum or equally approved material in accordance with manufacturers / consultant's instructions.

14.6 FLUSH DOORS

Flush doors shall be solid cored as per description in Bill of Quantities covered on both side with commercial ply or Teak veneered block board as specified in drawing. The doors shall be lipped and edges fitted and hung to the frames. The flush door shall be obtained from the source approved by the consultant and shall be of uniform quality and texture.

14.7 FABRICATION

- (a) The contractor shall perform all necessary groovings, notching, tonguening, housing, rebating and all other work necessary for the correct jointings. The contractor shall also provide all metal plates, screws, nails and other fixing that may be necessary for the proper execution of the joinery work specified. The contractor shall also required to carry out all works necessary for the proper construction of all framings, etc. and for their support and fixing in the building. All wood work shall be approved and initialled be the consultant or Engineer before being fixed in position.
- (b) Any joinery which may show signs of defects arising from the unsound materials or defective workmanship before the expiry of the maintenance period shall be cut out and replaced at contractor's own expense.
- (c) All hold-fast are to be cut to size and shall be 1/8" thick M.S. flat iron as shown on the drawing.
- (d) Solid wood frames as per BOQ or as shown on drawing are to be prepared with posts tenoned with the beads or as shown on the drawings.
- (e) The shutters will be fixed to the frames with approved quality fittings. The frames will be secured with wrought iron clamps.
- (f) All doors and windows shutters shall be fabricated in workman like manner in accordance with the drawings or as directed by the Engineer.
- (g) All articles of ironmongery to be soundly and strongly made well finished and equal in quality to first grade articles of approved manufacturers.
- (h) Steel fittings are to be furnished and oxidized on exposed surfaces. Aluminum fittings are to be anodized on exposed surfaces. Aluminum fittings are to be the best quality of their kind and shall have a base coat of brass or copper.

- (i) Locks, or knob sets, handles, heavy handles etc. shall be as specified and approved by Engineer / Consultant.
- (j) Paint and Polish shall be carried out as specified in relevant section.
- (k) Anti-termite treatment of approved quality shall be applied to frames on the surface in contact with earth, or wall etc. as per directions of Engineer. Contractor's rates in BOQ for doors, windows shelves etc. shall include this item and no additional payment shall be made.
- (l) (i) Three coats of Enamel paint should be applied on all wood work after preparing all surfaces.
- (ii) Three coats of Enamel paint on all steel works over priming coat of Red oxide.

14.8 SHOP DRAWINGS AND SAMPLES

The contractor should submit the shop drawings for the approval of Consultants or should submit sample of one complete door and window for approval of Consultant / Owner.

15. GLAZING

15.1 SCOPE OF WORK

The work covered under this section of specifications consists of furnishing all labour material, tools and plants and performing all operations in connection with fixing of the glass to the doors windows, skylights etc in accordance with the drawings, as specified herein and subject to the terms and conditions of the contract.

15.2 GENERAL

- (a) Size of glass indicated on drawings are only approximate actual sizes required shall be determined by measuring all panels. Glass shall be without wave, distortion or bulbs.
- (b) For wooden Doors and Windows, where provided, glass shall be secured in place with Deodar wood beading.
- (c) All glass shall be of manufacture and quality approved by the consultant or Engineer. 5 mm thick glass should be used in doors and windows and 3 mm thick glass should be used in ventilators.

15.3 ACCEPTANCE

Glass shall be protected against damage. After inspection any labels, paint smears and the glass shall be washed clean on both sides. Damaged or broken glasses shall be removed and replaced with new ones before acceptance at no additional cost.

15.4 ROOF WATER PROOFING AND INSULATION

Providing and Supplying Heat & U/V resistant Protective Liquid Membrane Roof water proofing water shield ZSAC-10/55 of M/s ZAHABIYA or MATRIX water stopper MT 22/6 in white colour etc. etc. complete as described in Nomenclature of BOQ.

16. PAINING AND FINISHING

16.1 SCOPE OF WORK

The work covered in this section of the specifications consists of furnishing all plants, labour, equipment, appliances and materials and in performing all operations in connection with protective and general painting and finishing complete in strict

accordance with this section of the specifications and applicable drawings and subject to the terms and conditions of the contract.

16.2 GENERAL

The terms "Paints" as used herein means enamel paints Emulsion Paint, primers, colour washes, chalk washes etc. All colours shall be subject to the approval of the Consultants / Owner.

All Paints shall be of first class quality product made by an approved manufacturer ICI or equivalent approved and shall conform to the requirements of current British Standards specifications or ASTM standards.

16.3 All colours and shades shall be as directed by the Consultants / Owner. The colour of each coat of paint shall not be of a different shade from the following coat.

17. COOPERATION WITH OTHER TRADES

(a) All work under this section shall be coordinated with the work to be done as specified under other sections of the specifications.

(b) The contractor shall drill, tap, cut and fit the work included herein as required, to accommodate work of other trades in conjunctions with it.

18. SAMPLE

Samples of materials specified shall be submitted for approval when required by the Consultant / Owner.

TECHNICAL SPECIFICATIONS – AIR CONDITIONING & MECHANICAL VENTILATION WORKS

1.0 GENERAL:

The contract drawings indicate the extent and general arrangement of the Air Conditioning and Mechanical Ventilation System. Equipments, ducting and piping shall fit into the space allotted and shall allow adequate and acceptable clearance for entry, servicing and maintenance. Where component parts of equipment or system cannot be service without distributing adjacent work resulting from original installation of other work, corrective action satisfactory to the Client / Project Managers / Consultant shall be taken, without any additional cost to the Owner.

- (a) Capacities of equipment and materials shall not be less than those indicated.
- (b) Conformance with Agency requirements: Where materials or equipment are specified to conform to requirements of Air-conditioning and Refrigeration Institute of Heating, Refrigeration and Air-conditioning Engineers, etc., the Contractor shall submit proof of conformance. The label or listing of the specified agency will be acceptable evidence.
- (c) Nameplates: Each major item of equipment shall have the manufacturer's name, address serial and model numbers on a plate securely attached to the item.
- (d) Protective and Access requirements: Belts, pulleys, chains, gears, coupling, projecting set-screws, keys and other rotating parts are so located that any person in close proximity shall be fully enclosed or properly guarded. High temperature equipment and piping so located as to endanger personnel or create a fire hazard shall be properly guarded or covered with insulation of a type as specified by the manufacturer. Items such as catwalk ladders and quadrails shall be provided where indicated for safe operation and maintenance of equipment.
- (e) Verification of dimensions: The Contractor shall visit the premises to thoroughly familiarize himself with all details of the work and working conditions and verify all dimensions in the field, and shall advise the Client / Project Managers / Consultant of any discrepancy before performing any work. The Contractor shall be specifically responsible for the co-ordination and proper relation of his work to the building structure and to the work of all trades.
- (f) Pipes crossing fire rated wall, the gap between wall and pipes shall be filled with soft packing like mineral wool, the ends shall be closed with approved sealant shall be deemed to have been included in the relevant items.

1.1 Equipment and Material:

(a) General:

These shall conform to the respective publications and other requirements specified herein, and as shown on the drawings and shall be the products of the manufacturers regularly engaged in the manufacture of such products. Items of equipment shall essentially be duplicate of equipment that has been in satisfactory use at least 10 years prior to bid opening and shall be supported by a service organization that is, in the opinion of the Client / Project Managers / Consultant, reasonably convenient to the site. It shall be solely the Contractor's responsibility to ensure that the equipment / material supplied by him shall fit into the space allotted for the purpose. If at any stage it is detected that the equipment supplied by him cannot fit into the space provided for the equipment, then the Contractor shall be responsible for supplying other equipment of suitable size, without incurring any additional cost to the Owner.

(b) Approval of Equipment and Material:

Before starting installation of any material or equipment, the Contractor shall submit for approval, working drawings of all areas and lists of materials and equipments to be incorporated in the work. The layout drawings shall include a plan and elevations of the proposed work, piping and equipment to establish that the equipment will fit in the allotted space with clearances for installation and maintenance. The drawings shall show proposed details for attachment anchoring, and hanging to structural framing of the building; vibration isolation units; foundation and support; location and size of sleeves and prepared openings for passage of pipes. If departures from the contract drawings are deemed necessary by the Contractor, details of such departures including changes in related portions of the project and the reasons thereof shall be submitted with the drawings. Approved departures shall be made at no additional cost to the Owner. A complete electrical connection diagram, for each electrically controlled component having automatic or manual control device, shall be submitted for approval. Wiring diagrams shall identify each component and one diagram shall show all interconnected or interlocked components. The lists of materials and equipment shall be supported by sufficient descriptive

material, such as catalogs, diagrams, performance curves, charts, Layout drawings and other data published by the manufacturer, to demonstrate conformance to the specifications requirements; model numbers alone will not be acceptable. The data shall also include the name and address of the nearest service and maintenance organization that regularly stock repair parts. Listings of items that function as parts of an integrated system shall be furnished at one time. One copy of the layout drawings, wiring diagrams and lists will be returned, marked to indicate approval.

All material / equipment shall be submitted for approval and only approved material / equipment shall be supplied to the site.

1.2 Equipment and Material:

The contract shall provide at his cost, samples of material, equipment for approval by the Engineer before order is placed for the same. Engineer may waive this requirement, if detailed published catalogues submitted by the contractor provide sufficient information for approval. These samples shall include but not limited to:

- (a) Pipe Insulation and Covering
- (b) Adhesive and Tapes
- (c) Electrical Items (Power and Control Cables, Conduit, Circuit Breakers)
- (d) Hangers and supports
- (e) Copper Piping and fittings
- (f) Condensate Drain Piping and fittings

2.0 DX SPLIT AIR CONDITIONING UNITS:

2.1 General:

Dx Split system air-conditioning Units, cool only type Units to be in two parts indoor & outdoor units, including filters, evaporator coils, compressors, condenser coils, and fan section, connection to electric power point, refrigerant piping, remote sensors, control wiring, complete in all respect.

Provide units pre-piped, pre-wired, pre-charged refrigerant gas (Ozone Friendly Green Gas), factory assembled and factory tested, with all controls pretested prior to shipping. Provide a terminal strip with each electrical component individually and separately wired to strip. Provide a separate fuse, internally mounted, for each electrical component. A single fuse for multiple compressors or fan motors will not be accepted.

2.2 Indoor Unit:

2.2.1 Cabinet, Casing and Frame:

Unit framework to be formed of structural steel members of 12 to 14 gauge mild steel. After assembly paint the framework for maximum protection against rust. Exterior panels to be fabricated of 18 gauge galvanized steel finished with a baked acrylic enamel over an epoxy primer. Provide neoprene gasketing between panels and frame members; panels to be attached to the frame with quick release latches (no sheet metal screws). Insulate sections including compressor compartment with 1" thick, 3-lb./cu. ft. density fiberglass having an R value of 4.16.

Arrange units for full front, side and rear service access to all mechanical, electrical and refrigeration controls, check out of electrical control panel, without disrupting or interfering with air flow.

2.2.2 Supply Fan and Motor:

Provide single width, forward curved Class I & II supply fans secured to a machined, ground and polished solid steel shaft. Coat shaft with a rust inhibitor and support by two outboard bearings selected for a minimum 200,000 hours average life.

Provide three-phase NEMA design 'B', 40qC continuously rated fan motor with energy-saving design, .85 power factor, NEMA 'T' frame, open drip-proof, operating at 1750 rpm and supplied with grease-lubricated ball bearings.

2.2.3 Direct Expansion Coil:

Provide direct expansion coil with ½" OD seamless copper tubes

Expanded into copper fins, not less than 3 rows deep or more than 12 fins per inch. Provide evaporator coil with a distributor with side port for hot gas bypass and thermostatic expansion valve with adjustable superheat and external equalizer. Test coil at 300 PSIG air pressure under water, completely dehydrate and pressure test with refrigerant. Provide coils with heavy gauge, insulated, galvanized steel drain pans complete with mastic coating for corrosion protection.

2.2.4 Filters:

Provide filters having a 40% ASHRAE dust spot efficiency, U.L. Class I pleated media type 2-inch deep.

2.2.5 Evaporator Defrost Thermostat:

Provide defrost thermostat package with enclosure, wiring and hardware for field installation.

2.3 Condensing Unit:

2.3.1 General:

Provide units pre-piped and pre-wired, pre-charged refrigerant gas, factory assembled and factory tested, with all controls pre-tested prior to shipping. Design units for use with Ozone Friendly Green Gas Refrigerant.

Assemble all condenser components on a common base in a weatherproof housing. Provide condenser coil, condenser fans and motors, refrigerant reservoir, charging valve, all controls and holding charge of Refrigerant.

2.3.2 Condenser Coil:

Construct condenser coil of copper plate fins, mechanically bonded to seamless copper tubes. Circuit coil for sub-cooling. Test coils to 425 psi.

2.3.3 Condenser Fans and Motors:

Furnish direct driven, propeller type belt driven, centrifugal fans arranged for vertical horizontal discharge. Provide condenser fan motors of the permanently lubricated type, resiliently mounted. Provide a safety guard for each fan. Include controls for cycling fans for intermediate season operation and low ambient control. Balance each fan statically and dynamically.

2.3.4 Controls:

Locate factory wired controls in a separate enclosure. Provide high and

Low pressure switches and compressor overload devices. Incorporate a positive acting timer to prevent short cycling of compressor if power is interrupted. Timer to prevent compressor from restarting for approximately 5 minutes after shutdown.

2.3.5 Refrigerant Circuits:

Each refrigerant circuit is to be an independent circuit completely piped, tested, dehydrated and fully charged with oil and Ozone Friendly Green Gas Refrigerant. The Refrigerant circuits are to include compressor, condenser coil with integral liquid sub-cooler, liquid line service and charging valve, filter drier, and sight glass. Compressor units to include suction and discharge line braided-wire isolators.

2.3.6 Casing:

Make unit casing fully weatherproof for outdoor installation. Construct casing of galvanized steel, zinc phosphatized and finished with baked enamel. Provide openings for power and refrigerant connections. Make panels removable for servicing. Provide heavy duty coil guards, unit mounting rails and drain holes.

2.4 Execution:

Provide refrigerant piping and accessories to connect condensing unit's condensers to indoor air conditioning units according to manufacturer's instructions.

Copper pipes shall be insulated with 1-1/4" (32 mm) thick closed cells synthetic elastomeric foam insulation and wrapped with self-adhesive waterproofing tape. Condensate drain shall be insulated with 3/8" (10mm) thick closed cell synthetic elastomeric foam insulation. Contractor to provide minimum 25 mm dia Condensate Drain and terminate to nearest drain point.

No insulation shall be applied to any system of piping until all pipe work has been tested, cleaned out and made tight. All insulation shall be applied in a manner consistent with good practice and methods. All longitudinal joints of pipe shall be at the top and bottom. Insulation shall be continuous through walls, floors, ceiling and partitions etc.

All insulated refrigerant pipes exposed to atmosphere shall be provided with a cladding of 26 gauge (0.55 mm) thick G.I. or aluminium sheet metal with proper support system for cladding works. Cladding works shall be painted with one coat of primer and two coats of finish paint, as approved by the Engineer and as direct by Engineer in charge.

2.4.1 Startup and Testing:

- a. Manufacturer's service technician to check alignment of bearings, drives and motors after installation to ensure that no misalignment exists, or make any necessary alignment adjustments prior to startup.
- b. The manufacturer shall furnish a start up check list to the Owner at least two months prior to start up. The list must be explicit as to the various items to be checked prior to start up.
- c. Before units are started up, manufacturer to pump new grease into bearing housings to force out old grease and provide adequate lubrication.
- d. Before acceptance of the equipment by the Owner, conduct all tests as required to demonstrate that the equipment operates mechanically, electrically and acoustically as specified.
- e. Conduct a satisfactory performance test in the presence of the Owner / Engineer incharge. Any units found to vibrate beyond acceptable levels must be rebalanced in the field at the Contractor's expense.

2.5 Spare Compressors and Parts:

Minimum 10% spare shall be supplied as per Manufacturer's recommendations for two years continues operation.

3.0 VENTILATION AND EXHAUST FANS:

3.1 GENERAL:

The contractor shall supply and install fans of the type and capacity specified in Schedule Sheet and conforming to the specifications given herein. The contractor shall be responsible for the proper selection of the fans so that the specified operating conditions are obtained. Connection to the electric power point is in contractor scope. Motor shall be sized to provide the required BHP for meeting the specified conditions without overloading. The Fans shall be provided as per List of Approved Manufacturer's.

External static pressure given in the schedule are indicative and for guidance only. The Contractor shall calculate the external and total static pressure for all fans and shall submit the same for Engineer's review and approval before ordering the fans. Required fan and motor shall be provided without any additional cost and no variation or claim shall be entertained in this regard.

3.2 PROPELLER FANS:

Shall be supplied of the quality indicated on the drawings. Propeller fans shall operate on 220V/1 phase/50 Hertz A.C. current. Fans shall be directly mounted on the motor, and shall operate without disturbing noise, during normal operation. The discharge side of the fan shall be provided with self-closing shutters. Propeller fans shall be as manufactured by National Japan or approved equal local brand.

3.3 INSTALLATION:

3.3.1 General: Fans as shown on drawings shall be installed by the Contractor, complete in all respects and as per satisfaction of the Consultants. Fans shall be rigidly secured so that they operate without vibration and transmission of vibration to the structure shall be through isolated. Connection to ducting shall be through flexible connectors. Ducting connection to fan shall ensure lowest turbulence and smooth transition of sizes. All supporting arrangements of the fans shall be drawn up by the Contractor and submitted to the Engineer for approval.

Floor mounted fans shall be installed on concrete housekeeping pad at minimum of 100 mm above the floor, fan shall be mounted on vibration isolator. Structural suspended fans shall be installed using threaded rods and vibration isolator.

3.3.2 Commission & Testing: The fans shall be commissioned and tested by the Contractor

6.0 LIST OF APPROVED MANUFACTURERS:

S.NO.	EQUIPMENT / MATERIAL	RECOMMENDED MANUFACTURERS
1	WALL MOUNTED DX SPLIT AIR CONDITIONING UNITS	a) DAIKIN b) GREE c) HITACHI d) MITSUBISHI
2	COPPER PIPING	a) MUELLER b) YORKSHIRE c) CRANE ENFIELD d) NIBCO
3	HANGERS & SUPPORTS	a) HILTI, GERMANY b) FISHER, GERMANY c) SIKLA, UK d) MUNGO, SWITZERLAND
4	HVAC FANS	a) SASA. b) AEROTECH c) JALAL
5	ELECTRIC CABLES	a) PAKISTAN CABLES b) NEW AGE CABLES c) POWER CABLES
6	STEEL CONDUIT FOR ELECTRICAL WORKS	a) HILAL, PAKISTAN b) PREMIER, PAKISTAN

PLUMBING SYSTEM WORKS SPECIFICATIONS

DOMESTIC WATER PIPING

PART 1 - GENERAL

1.0 RELATED DOCUMENTS

- a. Drawings and general provisions of the Contract, including General and Supplementary Conditions apply to this Section.

2.0 SUMMARY

- a. This Section includes domestic water piping inside the building.

3.0 DEFINITIONS

- a. CPVC: Chlorinated polyvinyl chloride plastic.
- b. PEX: Crosslinked polyethylene plastic.
- c. PVC: Polyvinyl chloride plastic.
- d. PPR: Poly propylene Random

4.0 PERFORMANCE REQUIREMENTS

- a. Provide components and installation capable of producing domestic water piping systems with 125 psig (860 kPa) unless otherwise indicated.

5.0 SUBMITTALS

- a. Product Data: For pipe, tube, fittings, and couplings.
- b. Water Samples:
- c. Field quality-control test reports.

6.0 QUALITY ASSURANCE

- a. Piping materials shall bear label, stamp, or other markings of specified testing agency.
- b. Comply with NSF 14, "Plastics Piping System Components and Related Materials," for plastic, potable domestic water piping and components
- c. Comply with NSF 61, "Drinking Water System Components - Health Effects; Sections 1 through 9," for potable domestic water piping and components.

PART 2 - PRODUCTS

1.0 MANUFACTURERS

- a. In other Part 2 articles where titles below introduce lists, the following requirements apply to product selection:
 - 1. Manufacturers: Refer Approved List of Manufacturers.

2.0 PIPING MATERIALS

- a. The pipe materials shall as stated below.

3.0 DOMESTIC COLD WATER BELOW AND ABOVE GRADE

- 1. Polypropylene pipes and pipe fitting PN20 to DIN 8077 for pipe size upto 110mm dia.
- 2. uPVC pipes to BS 3505 with Class E with solvent welded fittings to BS 4346 for pipe sizes above 110mm dia.

4.0 DOMESTIC HOT WATER PIPING

- 1. Polypropylene pipes and pipe fitting PN20 to DIN 8077 for pipe size upto 110mm dia.
- 2. cPVC Sch 80 pipes with solvent welded fittings for pipe sizes above 110mm dia.

5.0 IRRIGATION PIPES

- 1. uPVC pipes to BS 3505 with Class E with solvent welded fittings to BS 4346 for all pipe sizes.

6.0 VALVES

- a. Generally, all valves of the same type shall be of the same manufacturer. All gate, globe, angle, and swing check valves as a group shall be of the same manufacturer. All valves 50 mm and smaller shall be threaded and have bronze bodies.
- b. All valves 65 mm and larger shall be Cast iron type and shall be flanged (or grooved for grooved coupling joints).
- c. For PPR piping use PPR Coated valves of the same piping material and manufacturer.
- d. Each valve shall be marked (engraved, stamped, or cast on each valve or metal tag, permanently attached to the valve) at the factory with the following minimum information
 - 1. Manufacturer's Name.
 - 2. Catalogue or Figure No.
 - 3. Size and Pressure Class.
- e. Arrows to indicate direction of flow on check, globe, angle, non-return, and eccentric plug valves.

7.0 GATE VALVES

- a. [Size 50 mm and Smaller]. Furnish bronze valves with screwed-in bonnet, non-rising stem, solid wedge disc, and threaded ends. Pressure rating PN20.
- b. [Size 65 mm and Larger]. Furnish Iron Body Bronze Mounted (IBBM) valves, i.e. cast iron body bronze trim valves, with bolted bonnet, non-rising stem, solid wedge disc, flanged ends, and renewable seat rings.

8.0 GLOBE VALVES.

- a. [Size 50mm and Smaller]. Furnish valves designed for minimum PN20 working pressures.
- b. [Size 65 mm and Larger]. Furnish valves designed for minimum PN16 working pressure.

9.0 CHECK VALVES

- a. [50 mm and smaller]. Furnish swing valves designed for minimum PN20 non-shock working pressures. Valves shall have renewable discs and side plugs, integral seats.
- b. [Size 65 mm and Larger Water Check Valves]. Valves shall be silent type spring loaded of the double door or wafer style. Valves shall be designed for minimum PN16 non shock water working pressure.

10.0 RELIEF VALVES.

Domestic Water Temperature and Pressure Relief Valve.

- a. On hot water storage tanks provide an ASME rated thermostatic, self-closing, temperature and pressure relief valve, located in the relief valve openings of tanks. Valve shall have a minimum thermal discharge capacity equal to the input capacity of the heater standard pressure setting of 600 kPa and standard temperature setting of 100 - 140 degrees C. Relief valve pipe to discharge to floor drain.

11.0 BALL VALVES.

- a. [Size 50 mm and Smaller]. Valves shall be standard port, 2-piece construction with screwed ends. Valves shall be designed for minimum PN25. Valves shall have bronze or brass body, stainless steel ball, steel handle with vinyl grip.
- b. [Size 65 mm and Larger]. Valves shall be standard port, BS 5159 with flanged ends. Valves shall be designed for minimum PN16 working pressure. Valves shall have steel body, chrome or nickel plated steel or stainless steel ball.

12.0 FLOAT VALVES

- a. Float valves shall be installed as indicated in the drawings to provide consistent level control in reserve supply water storage tanks. The valve shall meet the requirements of the Water Byelaws for air gaps and shall be constructed throughout in approved materials and shall prevent back siphoning. Bronze equilibrium float valves 80 and above shall be flanged end, flat faced and drilled to suit BS4504 PN16.

- b. Bronze equilibrium float valves upto 50 shall be screwed end BS2779 parallel and shall be provided complete with back nut.
- c. Floats for valve sizes 80mm and above shall be of copper.

13.0 SOLENOID VALVES

- a. Electrically operated solenoid valves shall be single phase 220V and shall be rated for the system pressure

14.0 BIB TAPS

- a. Bib-cocks shall be in accordance with BS 1010: 1973. They shall be provided with hose union nosepiece and hand wheel operated.

15.0 AUTOMATIC AIR VALVES

- a. Automatic air valves shall have a bronze body with bolted cover and a 9mm top outlet.

16.0 STRAINERS

- a. Up to and including DN50 strainers shall be manufactured from bronze and shall be of the 'Y' type with bolted cap, PN25 temperature/pressure rating.
- b. Strainers above DN50 shall be manufactured from cast iron and shall be of the 'Y' type with bolted cap, PN16 temperature/pressure rating and shall be complete with drilled and tapped caps complete with drain cocks.
- c. Strainers shall be provided with a medium grade screen sized such that in their clean condition the maximum pressure drop at the design flow rate shall not exceed 6kPa.

PART 3 - EXECUTION

1.0 EXCAVATION

- a. Excavating, trenching, and backfilling are specified in Section "Earthwork."

2.0 PIPE AND FITTING APPLICATIONS

- a. Transition and special fittings with pressure ratings at least equal to piping rating may be used in applications below, unless otherwise indicated.
- b. Flanges may be used on aboveground piping, unless otherwise indicated.
- c. Grooved joints may be used on aboveground grooved-end piping.

3.0 VALVE APPLICATIONS

- a. Drawings indicate valve types to be used. Where specific valve types are not indicated, the following requirements apply:
 1. Shutoff Duty: Use bronze ball or gate valves for piping NPS 2 (DN 50) and smaller. Use cast-iron butterfly or gate valves with flanged ends for piping NPS 2-1/2 (DN 65) and larger.
 2. Hot-Water-Piping, Balancing Duty: Calibrated balancing valves.
 3. Drain Duty: Hose-end drain valves.
- b. PPR Coated PN-25 rated ball, butterfly, and check valves may be used in matching piping materials.

4.0 PIPING INSTALLATION

- a. Install domestic water piping level without pitch and plumb.
- b. Rough-in domestic water piping for water-meter installation according to utility company's requirements.

5.0 HANGER AND SUPPORT INSTALLATION

- a. Install supports according to Division 15 Section "Hangers and Supports."
- b. Support vertical piping and tubing at base and at each floor.
- c. Rod diameter may be reduced 1 size for double-rod hangers, to a minimum of 3/8 inch (10 mm).
- d. Install hangers for PVC/cPVC/PPR and PE piping with the following maximum horizontal spacing and minimum rod diameters:
 1. NPS 2 (DN 50) and Smaller: 48 inches (1200 mm) with 3/8-inch (10-mm) rod.
 2. NPS 2-1/2 to NPS 3-1/2 (DN 65 to DN 90): 48 inches (1200 mm) with 1/2-inch (13-mm) rod.
 3. NPS 4 and NPS 5 (DN 100 and DN 125): 48 inches (1200 mm) with 5/8-inch (16-mm) rod.
 4. NPS 6 (DN 150): 48 inches (1200 mm) with 3/4-inch (19-mm) rod.
 5. NPS 8 (DN 200): 48 inches (1200 mm) with 7/8-inch (22-mm) rod.
- e. Install supports for vertical PVC/cPVC/PPR piping every 48 inches (1200 mm).

6.0 FIELD QUALITY CONTROL

- a. Inspect domestic water piping as follows:
 1. Do not enclose, cover, or put piping into operation until it has been inspected and approved by authorities having jurisdiction.
 2. During installation, notify authorities having jurisdiction at least 24 hours before inspection must be made. Perform tests specified below in presence of authorities having jurisdiction:
 - a. Roughing-in Inspection: Arrange for inspection of piping before concealing or closing-in after roughing-in and before setting fixtures.
 - b. Final Inspection: Arrange final inspection for authorities having jurisdiction to observe tests specified below and to ensure compliance with requirements.

3. Reports: Prepare inspection reports and have them signed by authorities having jurisdiction.
- b. Test domestic water piping as follows:
1. Fill domestic water piping. Check components to determine that they are not air bound and that piping is full of water.
 2. Test for leaks and defects in new piping and parts of existing piping that have been altered, extended, or repaired. If testing is performed in segments, submit separate report for each test, complete with diagram of portion of piping tested.
 3. Leave new, altered, extended, or replaced domestic water piping uncovered and unconcealed until it has been tested and approved. Expose work that was covered or concealed before it was tested.
 4. Cap and subject piping to water pressure of 150 psi or 50 psi above operating pressure, without exceeding pressure rating of piping system materials. Isolate test source and allow to stand for four hours. Leaks and loss in test pressure constitute defects that must be repaired.
 5. Repair leaks and defects with new materials and retest piping or portion thereof until satisfactory results are obtained.
 6. Prepare reports for tests and required corrective action.

DOMESTIC WATER PIPING SPECIALTIES

PART 4 - GENERAL

1.0 RELATED DOCUMENTS

- a. Drawings and general provisions of the Contract, including General and Supplementary Conditions Specification Sections, apply to this Section.

2.0 SUMMARY

- a. This Section includes the following domestic water piping specialties:
 1. Balancing valves.
 2. Strainers.
 3. Outlet boxes.
 4. Hose stations.
 5. Hose bibs.
 6. Drain valves.
 7. Water hammer arresters.
 8. Air vents.
 9. Flexible connectors
 10. Flow Sensing Devices
 11. Puddle flanges

3.0 PERFORMANCE REQUIREMENTS

- a. Minimum Working Pressure for Domestic Water Piping Specialties: 125 psig (860 kPa), unless otherwise indicated.

4.0 SUBMITTALS

- a. Product Data: For each type of product indicated.
- b. Shop Drawings:
- c. Field quality-control test reports.
- d. Operation and Maintenance Data: For domestic water piping specialties to include in emergency, operation, and maintenance manuals.

PART 5 - PRODUCTS

1.0 BALANCING VALVES

- a. Refer Section 15140

2.0 HOSE BIBBS

- a. Hose Bibbs :
 - 1. Standard: ASME A112.18.1 for sediment faucets.
 - 2. Body Material: Bronze.
 - 3. Seat: Bronze, replaceable.
 - 4. Supply Connections: NPS 1/2 or NPS 3/4 (DN 15 or DN 20) threaded or solder-joint inlet.
 - 5. Outlet Connection: Garden-hose thread complying with ASME B1.20.7.
 - 6. Pressure Rating: 125 psig (860 kPa).
 - 7. Finish for Equipment Rooms: Rough bronze, or chrome or nickel plated.
 - 8. Finish for Service Areas: Rough bronze, or chrome or nickel plated.
 - 9. Finish for Finished Rooms: Chrome or nickel plated.
 - 10. Operation for Equipment Rooms: Wheel handle or operating key.
 - 11. Include operating key with each operating-key hose bibb.
- b. Gate-Valve-Type, Hose-End Drain Valves
 - 1. Standard: MSS SP-80 for gate valves.
 - 2. Pressure Rating: Class 125.
 - 3. Size: NPS 3/4 (DN 20).
 - 4. Body: ASTM B 62 bronze.
 - 5. Inlet: NPS 3/4 (DN 20) threaded or solder joint.
 - 6. Outlet: Garden-hose thread complying with ASME B1.20.7 and cap with brass chain.
- c. Stop-and-Waste Drain Valves :
 - 1. Standard: MSS SP-110 for ball valves or MSS SP-80 for gate valves.
 - 2. Pressure Rating: 200-psig (1380-kPa) minimum CWP or Class 125.
 - 3. Size: NPS 3/4 (DN 20).
 - 4. Body: Copper alloy or ASTM B 62 bronze.
 - 5. Drain: NPS 1/8 (DN 6) side outlet with cap.

PART 6 - EXECUTION

1.0 INSTALLATION

- a. Install water regulators with inlet and outlet shutoff valves. Install pressure gages on inlet and outlet.
- b. Install balancing valves in locations where they can easily be adjusted.
- c. Install Y-pattern strainers for water on supply side of each pump.
- d. Install water hammer arresters in water piping according to PDI-WH 201.
- e. Install air vents at high points of water piping. [Install drain piping and discharge onto floor drain.]
- f.

SANITARY WASTE, VENT AND STORM PIPING

PART 7 - GENERAL

1.0 RELATED DOCUMENTS

- a. Drawings and general provisions of the Contract, including General and Supplementary Conditions apply to this Section.

2.0 SUMMARY

- a. This Section includes the following for soil, waste, and vent piping inside the building:
 1. Pipe, tube, and fittings.

3.0 DEFINITIONS

- a. ABS: Acrylonitrile-butadiene-styrene plastic.
- b. EPDM: Ethylene-propylene-diene terpolymer rubber.
- c. LLDPE: Linear, low-density polyethylene plastic.
- d. NBR: Acrylonitrile-butadiene rubber.
- e. PE: Polyethylene plastic.
- f. PVC: Polyvinyl chloride plastic.
- g. TPE: Thermoplastic elastomer.

4.0 PERFORMANCE REQUIREMENTS

- a. Components and installation shall be capable of withstanding the following minimum working pressure, unless otherwise indicated:
 - 1. Soil, Waste, and Vent Piping: 10-foot head of water (30 kPa) .
 - 2. Sanitary Sewer, Force-Main Piping: 150 psig (1035 kPa).
- b. Seismic Performance: Soil, waste, and vent piping and support and installation shall be capable of withstanding the effects of seismic events.

5.0 SUBMITTALS

- a. Product Data: For pipe, tube, fittings, and couplings.
- b. Shop Drawings:
 - 1. Design Calculations: Signed and sealed by a qualified professional engineer for selecting seismic restraints.
 - 2. Drainage System: Include plans, elevations, sections, and details.
- c. Field quality-control inspection and test reports.

6.0 QUALITY ASSURANCE

- a. Piping materials shall bear label, stamp, or other markings of specified testing agency.

PART 8 - PRODUCTS

1.0 PIPING MATERIALS

- a. Piping materials shall be as under.

2.0 ABOVE GROUND SOIL, WASTE AND VENT PIPE

- a. All horizontal soil, waste pipes and rain water shall be Poly Propylene (PP) sound proof drainage pipes as per DIN 4109 and Din 4102 and fittings made of mineral-reinforced polypropylene homopolymer and copolymer. The typical density of the mineral filler shall be between 1.65 to 2.03 g/cm³ according to DIN 53479.
- b. The sound isolation shall be 13 DB for 4.0 l/s flow rate in accordance with DIN 52379 and DIN 4109
- c. The sound proof pipes & fittings shall be fire resistant class B2 to DIN 4102.
- d. The sound proof pipes & fittings shall be fungus and bacteria resistant, and shall have smooth surface, corrosion resistant.
- e. Soundproof drainage pipe system shall comply with following standards:
 - 1. DIN 4109m sound proof, absorption standards.
 - 2. DIN 4102, B2. Self-extinguishing flameless.
 - 3. DIN 19560 / DIN EN 1451. Hot water resistance, 95°C (Long term), 95°C (short term).

4. Physical Characteristics

Density	1.65 g/cm ³ DIN 53479
Elongation at break	50%
Tensile strength E-modulus Linear expansion	20N / mm ²
E-modulus	3800 N / mm ²
Linear expansion	0.04 mm / mk

5. The floor trap shall also be of sound proof material to DIN 4109.

3.0 BELOW GROUND SOIL AND WASTE PIPE

- a. uPVC conforming to the following British Standards:
 - 1. Pipes 110mm and 300mm diameter: uPVC pipe with solvent weld fitting as per BS 4660 (BS EN 1401)
 - 2. Pipes larger than 300mm diameter: to BS 3506.

4.0 STORM WATER PIPE

- a. Plastic pipes shall be extruded un-plasticized PVC (UPVC) conforming to the following British Standards:
 - 1. uPVC pipe with solvent joints (as approved by consultant) as per DIN 8061/8062 and ISO 3633 Type B

5.0 CONTENSATE DRAIN PIPING (ABOVE AND BELOW GRADE)

- a. uPVC conforming to the following British Standards:
 - 1. Pipes 20mm and 300mm diameter: Upvc class 'E' pipe with solvent weld fitting as per BS 3505 (EN 1401).

6.0 SPECIAL PIPE FITTINGS

7.0 ENCASEMENT FOR UNDERGROUND PIPING CROSSING DRIVEWAYS

- a. All Drainage pipes crossing driveways and subjected to heavy traffic shall be provided in concrete encasement.

PART 9 - EXECUTION

1.0 EXCAVATION

- a. Refer to "Earthwork" for excavating, trenching, and backfilling.

2.0 PIPING INSTALLATION

- a. Install cleanouts at grade and extend to where building sanitary drains connect to building sanitary sewers.
- b. Install cleanout fitting with closure plug inside the building in sanitary force-main piping.
- c. Make changes in direction for soil and waste drainage and vent piping using appropriate branches, bends, and long-sweep bends. Sanitary tees and short-sweep 1/4 bends may be used on vertical stacks if change in direction of flow is from horizontal to vertical. Use long-turn, double Y-branch and 1/8-bend fittings if 2 fixtures are installed back to back or side by side with common drain pipe. Straight tees, elbows, and crosses may be used on vent lines. Do not change direction of flow more than 90 degrees. Use proper size of standard increasers and reducers if pipes of different sizes are connected. Reducing size of drainage piping in direction of flow is prohibited.
- d. Lay buried building drainage piping beginning at low point of each system. Install true to grades and alignment indicated, with unbroken continuity of invert. Place hub ends of piping upstream.
- e. Install soil and waste drainage and vent piping at the following minimum slopes, unless otherwise indicated:
 1. Building Sanitary Drain: 2 percent downward in direction of flow for piping NPS 2 DN 50 and smaller; 1 percent downward in direction of flow for piping NPS 3 (DN 75) and larger.
 2. Horizontal Sanitary Drainage Piping: 1 percent downward in direction of flow.
 3. Vent Piping: 1 percent down toward vertical fixture vent or toward vent stack.
- f. Install PVC soil and waste drainage and vent piping according to ASTM D 2665.
- g. Install underground PVC soil and waste drainage piping according to ASTM D 2321.
- h. Do not enclose, cover, or put piping into operation until it is inspected and approved by authorities having jurisdiction or Consultant.

3.0 HANGER AND SUPPORT INSTALLATION

- a. Pipe hangers and supports are specified in Division 15 Section "Hangers and Supports." Install the following:
- b. Install hangers for PVC piping with the following maximum horizontal spacing and minimum rod diameters:
 1. NPS 1-1/2 and NPS 2 (DN 40 and DN 50): 48 inches (1200 mm) with 3/8-inch (10-mm) rod.
 2. NPS 3 (DN 80): 48 inches (1200 mm) with 1/2-inch (13-mm) rod.
 3. NPS 4 and 5 (DN 100 and 125): 48 inches (1200 mm) with 5/8-inch (16-mm) rod.
 4. NPS 6 (DN 150): 48 inches (1200 mm) with 3/4-inch (19-mm) rod.

5. NPS 8 to NPS 12 (DN 200 to DN 300): 48 inches (1200 mm) with 7/8-inch (22-mm) rod.
- c. Install supports for vertical PVC piping every 48 inches (1200 mm).

4.0 CONNECTIONS

- a. Drawings indicate general arrangement of piping, fittings, and specialties.
- b. Connect soil and waste piping to exterior sanitary sewerage piping. Use transition fitting to join dissimilar piping materials.
- c. Connect drainage and vent piping to the following:
 1. Plumbing Fixtures: Connect drainage piping in sizes indicated, but not smaller than required by plumbing code.
 2. Plumbing Fixtures and Equipment: Connect atmospheric vent piping in sizes indicated, but not smaller than required by authorities having jurisdiction.
 3. Plumbing Specialties: Connect drainage and vent piping in sizes indicated, but not smaller than required by plumbing code.
 4. Equipment: Connect drainage piping as indicated.

5.0 FIELD QUALITY CONTROL

- a. During installation, notify authorities having jurisdiction at least 24 hours before inspection must be made. Perform tests specified below in presence of authorities having jurisdiction.
 1. Roughing-in Inspection: Arrange for inspection of piping before concealing or closing-in after roughing-in and before setting fixtures.
 2. Final Inspection: Arrange for final inspection by authorities having jurisdiction to observe tests specified below and to ensure compliance with requirements.
- b. Reinspection: If authorities having jurisdiction find that piping will not pass test or inspection, make required corrections and arrange for reinspection.
- c. Reports: Prepare inspection reports and have them signed by authorities having jurisdiction.
- d. Test sanitary drainage and vent piping according to procedures of authorities having jurisdiction or, in absence of published procedures, as follows:
 1. Test for leaks and defects in new piping and parts of existing piping that have been altered, extended, or repaired. If testing is performed in segments, submit separate report for each test, complete with diagram of portion of piping tested.
 2. Leave uncovered and unconcealed new, altered, extended, or replaced drainage and vent piping until it has been tested and approved. Expose work that was covered or concealed before it was tested.
 3. Roughing-in Plumbing Test Procedure: Test drainage and vent piping, except outside leaders, on completion of roughing-in. Close openings in piping system and fill with water to point of overflow, but not less than 10-foot head of water (30 kPa). From 15 minutes before inspection starts to completion of inspection, water level must not drop. Inspect joints for leaks.

4. Finished Plumbing Test Procedure: After plumbing fixtures have been set and traps filled with water, test connections and prove they are gastight and watertight. Plug vent-stack openings on roof and building drains where they leave building. Introduce air into piping system equal to pressure of 1-inch wg (250 Pa). Use U-tube or manometer inserted in trap of water closet to measure this pressure. Air pressure must remain constant without introducing additional air throughout period of inspection. Inspect plumbing fixture connections for gas and water leaks.
5. Repair leaks and defects with new materials and retest piping, or portion thereof, until satisfactory results are obtained.
6. Prepare reports for tests and required corrective action.

6.0 PROTECTION

- a. Exposed PVC Piping: Protect plumbing vents exposed to sunlight with two coats of water-based latex paint.

DRAINAGE PIPING SPECIALTIES

PART 10 - GENERAL

1.0 RELATED DOCUMENTS

- a. Drawings and general provisions of the Contract, including General and Supplementary Conditions apply to this Section.

2.0 SUMMARY

- a. This Section includes the following drainage piping specialties:
 1. Cleanouts.
 2. Floor drains.
 3. Trench drains.
 4. Channel drainage systems.
 5. Roof drains.
 6. Manhole Covers
 7. Miscellaneous drainage piping specialties.

3.0 DEFINITIONS

- a. ABS: Acrylonitrile-butadiene-styrene plastic.
- b. FOG: Fats, oils, and greases.
- c. FRP: Fiberglass-reinforced plastic.
- d. HDPE: High-density polyethylene plastic.
- e. PE: Polyethylene plastic.
- f. PP: Polypropylene plastic.

- g. PUR: Polyurethane plastic.
- h. PVC: Polyvinyl chloride plastic.

4.0 SUBMITTALS

- a. Product Data: For each type of product indicated above.
- b. Shop Drawings: Show fabrication and installation details for frost-resistant vent terminals.
- c. Field quality-control test reports.
- d. Operation and Maintenance Data: For drainage piping specialties to include in emergency, operation, and maintenance manuals.

5.0 QUALITY ASSURANCE

- a. Drainage piping specialties shall bear label, stamp, or other markings of specified testing agency.

6.0 COORDINATION

- a. Coordinate size and location of concrete bases.
- b. Coordinate size and location of roof penetrations.

PART 11 - PRODUCTS

1.0 CLEANOUTS

- a. Plastic Floor Cleanouts:
 - 1. Size: Same as connected branch.
 - 2. Body: PVC.
 - 3. Closure Plug: PVC.
 - 4. Riser: Drainage pipe fitting and riser to clean out of same material as drainage piping.
 - 5. Finish: Stainless steel cap

2.0 FLOOR DRAINS

- a. Plastic Floor Drains:
 - 1. Material: PP Soundproof as per piping material
 - 2. Outlet: Side
 - 3. Sediment Bucket: Not required.
 - 4. Top or Strainer Material: Stainless steel <Refer Architect finishes schedule>.
 - 5. Top of Body and Strainer Finish: Stainless steel.
 - 6. Top Shape: Square. <Refer Architect finishes schedule>.
 - 7. Trap Material: Plastic drainage piping.
 - 8. Trap Pattern: Standard Multi Floor Trap with Multiple inlets and one outlet.

- b. Funnel floor drain where specified on drawings shall include a nickel bronze funnel secured to the grating

3.0 TRENCH DRAINS

- a. Trench Drains :
 1. Standard: ASME A112.6.3 for trench drains.
 2. Outlet: Side.
 3. Grate Material: Cast Iron/PVC. <Refer Architect finishes schedule>.
 4. Grate Finish: Epoxy coated for cast iron <Refer Architect finishes schedule>.
 5. Dimensions of Frame and Grate: Refer drawings
 6. Top Loading Classification: As mentioned on MEP drawings and BOQ.

4.0 ROOF DRAINS

- a. Plastic Roof Drains:
 1. Standard: ASME A112.21.2M.
 2. Pattern: Balcony/ Roof drain.
 3. Body Material: PVC.
 4. Dimensions of Body: Refer Drawings
 5. Outlet: Bottom.
 6. Dome Material: PVC/Stainless Steel <<Refer Architect finishes schedule>>.

5.0 MISCELLANEOUS DRAINAGE PIPING SPECIALTIES

- a. Vent Caps:
 1. Description: PVC of same brand as of piping.
 2. Size: Same as connected stack vent or vent stack.
- b. Expansion Joints:
 1. Standard: ASME A112.21.2M.
 2. Body: Cast iron with bronze sleeve, packing, and gland.
 3. End Connections: Matching connected piping.
 4. Size: Same as connected soil, waste, or vent piping.
- c. Manholes/gully traps covers
 1. All covers shall be Cast Iron with black bitumen coating. Manhole covers shall have clear opening of 600 x 600 mm.
 2. All manholes and gully traps shall be vented as per drainage department requirements.
 3. Gully trap covers shall have clear opening of 300 x 300 mm.
 4. All manhole covers and frames shall comply with BS 497:1976 (BS EN 124:1994)

PART 12 - EXECUTION

1.0 INSTALLATION

- a. Install cleanouts in aboveground piping and building drain piping according to the following, unless otherwise indicated:
 1. Size same as drainage piping up to NPS 4 (DN 100). Use NPS 4 (DN 100) for larger drainage piping unless larger cleanout is indicated.
 2. Locate at each change in direction of piping greater than 45 degrees.
 3. Locate at minimum intervals of 50 feet (15 m) for piping NPS 4 (DN 100) and smaller and 100 feet (30 m) for larger piping.
 4. Locate at base of each vertical soil and waste stack.
- b. For floor cleanouts for piping below floors, install cleanout deck plates with top flush with finished floor.
- c. For cleanouts located in concealed piping, install cleanout wall access covers, of types indicated, with frame and cover flush with finished wall.
- d. Install floor drains at low points of surface areas to be drained. Set grates of drains flush with finished floor, unless otherwise indicated.
 1. Position floor drains for easy access and maintenance.
 2. Install floor-drain flashing collar or flange so no leakage occurs between drain and adjoining flooring. Maintain integrity of waterproof membranes where penetrated.
 3. Install individual traps for floor drains connected to sanitary building drain, unless otherwise indicated.
- e. Install trench drains at low points of surface areas to be drained. Set grates of drains flush with finished surface, unless otherwise indicated.
- f. Assemble and install ASME A112.3.1, stainless-steel channel drainage systems according to ASME A112.3.1. Install on support devices so that top will be flush with surface.
- g. Install fixture air-admittance valves on fixture drain piping.
- h. Install stack air-admittance valves at top of stack vent and vent stack piping.
- i. Install air-admittance-valve wall boxes recessed in wall.
- j. Install flashing fittings on sanitary stack vents and vent stacks that extend through roof.
- k. Install through-penetration firestop assemblies in plastic stacks at floor penetrations.
- l. Install floor-drain, trap-seal primer fittings on inlet to floor drains that require trap-seal primer connection.
 1. Exception: Fitting may be omitted if trap has trap-seal primer connection.
 2. Size: Same as floor drain inlet.
- m. Install vent caps on each vent pipe passing through roof.

- n. Install frost-resistant vent terminals on each vent pipe passing through roof. Maintain 1-inch (25-mm) clearance between vent pipe and roof substrate.
- o. Install expansion joints on vertical stacks and conductors. Position expansion joints for easy access and maintenance.
- p. Install grease interceptors, including trapping, venting, and flow-control fitting, according to authorities having jurisdiction and with clear space for servicing.
 - 1. Above-Floor Installation: Set unit with bottom resting on floor, unless otherwise indicated.
 - 2. Flush with Floor Installation: Set unit and extension, if required, with cover flush with finished floor.
 - 3. Recessed Floor Installation: Set unit in receiver housing having bottom or cradle supports, with receiver housing cover flush with finished floor.
 - 4. Install cleanout immediately downstream from interceptors not having integral cleanout on outlet.
- q. Install grease removal devices on floor. Install trap, vent, and flow-control fitting according to authorities having jurisdiction. Install control panel adjacent to unit, unless otherwise indicated.
- r. Install oil interceptors, including trapping, venting, and flow-control fitting, according to authorities having jurisdiction and with clear space for servicing.
- s. Install solids interceptors with cleanout immediately downstream from interceptors that do not have integral cleanout on outlet. Install trap on interceptors that do not have integral trap and are connected to sanitary drainage and vent systems.
- t. Install traps on plumbing specialty drain outlets. Omit traps on indirect wastes unless trap is indicated.

2.0 CONNECTIONS

- a. Install piping adjacent to equipment to allow service and maintenance.
- b. Grease Interceptors: Connect inlet and outlet to unit, and connect flow-control fitting and vent to unit inlet piping. Install valve on outlet of automatic drawoff-type unit.
- c. Oil Interceptors: Connect inlet, outlet, vent, and gravity drawoff piping to unit; flow-control fitting and vent to unit inlet piping; and gravity drawoff and suction piping to oil storage tank.

3.0 LABELING AND IDENTIFYING

- a. Equipment Nameplates and Signs: Install engraved plastic-laminate equipment nameplate or sign on or near each of the following:
 - 1. Grease interceptors.
 - 2. Oil interceptors.
 - 3. Solids interceptors.
- b. Distinguish among multiple units, inform operator of operational requirements, indicate safety and emergency precautions, and warn of hazards and improper operations, in addition to identifying unit.

4.0 FIELD QUALITY CONTROL

- a. Perform tests and inspections and prepare test reports.
 - 1. Manufacturer's Field Service: Engage a factory-authorized service representative to inspect field-assembled FOG disposal systems and grease removal devices and their installation, including piping and electrical connections, and to assist in testing.
- b. Tests and Inspections:
 - 1. Leak Test: After installation, charge system and test for leaks. Repair leaks and retest until no leaks exist.
 - 2. Test and adjust controls and safeties. Replace damaged and malfunctioning controls and equipment.

5.0 PROTECTION

- a. Protect drains during remainder of construction period to avoid clogging with dirt or debris and to prevent damage from traffic or construction work.
- b. Place plugs in ends of uncompleted piping at end of each day or when work stops.

6.0 DEMONSTRATION

- a. Engage a factory-authorized service representative to train Owner's maintenance personnel to adjust, operate, and maintain FOG disposal systems and grease removal devices.

PLUMBING FIXTURES

7.0 QUALITY ASSURANCE

- a. Quality Standard: NSF 61 for fixture materials in contact with potable water.

8.0 WARRANTY

- a. Materials and Workmanship:
 - 1. Commercial Applications: One year.

9.0 FAUCETS

- a. Lavatory Faucets, <Refer Architecture fixture selection and Specifications>:
 - 1. Two-handle mixing non-pressure type valve.
 - a. Body Material: Commercial, solid brass (with non-metallic coatings or Chrome finish as required by the architect.
 - b. Finish: Polished chrome plate.
 - c. Maximum Flow Rate: Maximum [2.5 gpm (9.46 L/min.)],
 - d. Mounting: [Deck, exposed] [Deck, concealed] [Back/wall, exposed] [Back/wall, concealed].

- e. Spout: [Rigid, gooseneck] type.
 - f. Spout Outlet: Aerator/ Spray
- b. Sink Faucets, <Refer Architecture fixture selection and Specifications>::
- 1. [Kitchen faucet with spray, three-hole fixture].
 - a. Body Material: [Commercial, solid brass] (with non-metallic coatings or Chrome finish as required by the architect).
 - b. Finish: Polished chrome plate]
 - c. Maximum Flow Rate: 2.5 gpm (9.46 L/min.), unless otherwise indicated.
 - d. Mixing Valve: Two-lever handle.
 - e. Backflow Protection Device for Hose Outlet: Not required.
 - f. Mounting: Deck, Back/wall as recommended by the architect.
 - g. Spout Outlet: Aerator/ Spray
 - h. Drain: Stopper with chain.

10.0 TOILET SEATS

- a. Toilet Seats :
 - 1. Toilet seat for water-closet-type fixture.
 - a. Material: Molded, solid plastic.
 - b. Configuration: front with cover.
 - c. Size: Regular.
 - d. Class: Standard commercial.

11.0 FIXTURE SUPPORTS

- a. Water-Closet Supports :
 - 1. Combination carrier designed for standard mounting height of wall-mounting, water-closet-type fixture.
- b. Lavatory Supports:
 - 1. Type [lavatory carrier with exposed arms and tie rods] or [lavatory carrier with concealed arms and tie rod] for wall-mounting, lavatory-type fixture.
- c. Sink Supports:
 - 1. Type [sink carrier with exposed arms and tie rods] or [II, sink carrier with hanger plate, bearing studs, and tie rod] for sink-type fixture.

12.0 WATER CLOSETS (WESTREN)

- a. Water Closets, <Refer Architecture fixture selection and Specifications> :
 - 1. Floor-mounting, floor-outlet, vitreous-china fixture designed for [gravity-type tank] operation.

- a. Style: [Close coupled] [One piece].
 - 1) Bowl Type: Round front design. Include bolt caps matching fixture.
 - 2) Height: Standard.
 - 3) Design Consumption: Dual Flush Design with Major (6.0 L/flush) Minor (4 L/flush)].
 - 4) Tank: Gravity type. Include cover.
- b. Supply: [NPS 3/8 (DN 10)] [NPS 1/2 (DN 15)] chrome-plated brass or copper with wheel-handle stop.
- c. Toilet Seat: Included

13.0 WATER CLOSETS (EASTREN)

- a. Squatting WC, <Refer Architecture fixture selection and Specifications> :
 - 1. Flat Bowl, vitreous-china fixture designed for [gravity-type tank] operation.
 - 1) Type: Flat and Shallow design
 - 2) Flush Tank : Yes (check drawings for installation height)
 - 3) Design Consumption: Single Flush Design with Major (6.0 L/flush).
 - 4) Tank: Gravity type.
 - 5) Color (Refer Architecture fixture selection and Specifications)
 - b. Supply: [NPS 1/2 (DN 15)] chrome-plated brass or copper with wheel-handle stop.
 - c. DN50 supply pipe from Flush tank to WC. Pipe shall be concealed.

14.0 LIST OF APPROVED MANUFACTURERS:

EQUIPMENT DESCRIPTION	RECOMMENDED MANUFACTURER
European Water Closet	Owner Supplied or Grohe or equivalent
Flush Tank (Wall Mounted)	Owner Supplied or Grohe or equivalent
Wash Basin (Counter type)	Owner Supplied or Grohe or equivalent
Wash Basin (Half Pedestal)	Owner Supplied or Grohe or equivalent
Shower Assembly	Owner Supplied or Grohe or equivalent
Bath Tube Assembly	Owner Supplied or Grohe or equivalent
Kitchen Sink	Owner Supplied or Grohe or equivalent
Basin Mixer	Owner Supplied or Grohe or equivalent
Sink Mixer	Owner Supplied or Grohe or equivalent
Bottle Trap	Owner Supplied or Grohe or equivalent
Toilet Paper Holder	Owner Supplied or Grohe or equivalent
Transfer Pump, Booster Pump, Sump Pumps	KSB Pumps, Grundfos
Gas geysers	Super Asia, Canon
G.I. Pipes	KLM, IIL
PVC Pipes	IIL, Dadex, Advance Piping Industries
Valves	Niko, IIL, Advance Piping Industries
Floor traps, Drains, Roof drains	Jasom, Dadex, Beta Pipes,, Advance Piping Industries
PPRC pipes	Advance Piping Industries, Dadex

ELECTRICAL SPECIFICATION

SECTION –E - 1 GENERAL SPECIFICATIONS

FOREWORD

This document is to describe the minimum requirements for the equipment and installations and to ensure that the Contractor is fully aware of his duties to perform the required works, in accordance with the terms of the Contract.

1.0 SCOPE OF WORK

The works related to the electrical system which are included in the scope of this Contract are shown on the Drawings, stated in the Particular Specifications, Bill of Quantities and explained in these specifications. The works shall broadly include but not limited to the following:

Section – E2:	Low Voltage Switch Boards / Distribution Boards	Section –
E3:	Low Voltage Cable and Wires	Section – E4:
	Conduits and Pipes	
Section – E5:	Wiring Accessories	
Section – E6:	Interior Lighting Fixtures	
Section – E7:	Addressable Fire Alarm System	
Section – E8:	Telephone & Data Cabling System & Accessories	
Section – E9:	Cable Tray, Ladder and Trunking	
Section – E10:	Close Circuit Television (CCTV) System	
Section – E11:	Earthing System	

List of Approved Manufacturer

All material and equipment supplied by the Contractor shall be new and in all respects conform to the high standards of Engineering design, workmanship, performance and function as here in specified and fully meet the quality level and rugged requirements of the specifications.

The Contractor shall also be responsible to supply any other equipment not specifically mentioned in these documents but which is necessary for proper operation of the works / system, shall be considered to have been so specified and accordingly shall be provided by the Contractor as part of the Contract.

The Contractor shall be solely responsible for ensuring proper functional requirements of various equipment and shall also be responsible for furnishing any additional piece of equipment and for making modification in the equipment as desired and / or approved by the Owner or his representative, to achieve proper coordination with various equipment offered in the bid and also those installed by others.

Approval of the Contractor's supplied equipment / installation works shall not relieve the Contractor of any of his obligations or liabilities under the Contract, except insofar as provided under the conditions of the Contract.

2.0 RULES AND REGULATIONS

The entire electrical installation / work shall be carried out by licensed contractor, authorized to undertake such work under the provisions of Electricity Act 1910 and The Electricity Rules 1937 as adopted and modified up to date by the Government of Pakistan.

All works shall be carried out in accordance with the latest edition of the Regulations of the Electrical Equipment of Buildings issued by the Institute of Electrical Engineers - London, the Contract documents, the Electricity Rules 1937 and bye-laws that are in force from time to time. Any discrepancy between these specifications and any other rules and regulations shall be brought to the notice of Owner or his representative, and his decision shall be final and conclusive.

The Contractor shall be responsible for completing all formalities and submitting the test certificates as per prevailing rules and regulations and shall have the installation passed by the Government Electric Inspector of that region. All requirements of the Electric Inspector and the Electric Company shall be complied with.

3.0 STANDARDS

All works, equipment and materials shall conform to:

On the one hand:

The specification recommended practices, official standards and codes the non - restrictive List of which is given below.

International Electro-technical Commission (IEC)

British Standards (BS)

National Electric Code (NEC)

National Standards

In the event of conflict between standards, the most stringent shall prevail.

Whenever the electrical equipment to be installed, does not hold national standards, the Contractor shall take into account the specific standards chosen by the Owner and make sure that the equipment he has to install, meets these standards.

In addition, even if no mention is stipulated in this specification, it is implied that the equipment be tropicalized, if required, by the conditions of the site of installation.

In any case, the standards and codes to be taken into consideration are those in force at the date of delivery.

4.0 INSTALLATION AND SERVICE CONDITIONS

4.1 Site Conditions

All material and equipment supplied and installed shall be designed, manufactured and tested to meet the following ambient conditions unless specifically stated otherwise for any material / equipment:

- a. Maximum outdoor ambient temperature : 45 degree C
- b. Minimum Indoor ambient temperature : 0 degree C
- c. Maximum relative humidity : 90 %
- d. Minimum relative humidity : 26 %

4.2 Service Conditions

Equipment shall be designed and built for continuous service with a minimum of supervision and maintenance.

5.0 MAIN ELECTRICAL CHARACTERISTICS

5.1 Power Supply System

Unless otherwise specified elsewhere, all equipment and material shall be designed to operate and function satisfactorily with the following minimum requirements without any de-rating:

- Voltage 400 ± 10%
- Phase 3, 4 wire system
- Frequency 50 Hz. ±2 Hz.

5.2 Degree of Protection of Enclosures

For indoors, IP31 minimum degree of ingress protection of the enclosures against contact with line or moving parts and against ingress of solid foreign bodies or liquids, shall be selected, in accordance with IEC 60529.

6.0 GUARANTEE

The Contractor shall furnish written grantee which should clearly state that the works he will carry out as well as the materials he will supply, meet with this specification and that compliance thereto constitutes an official clause, added by implication to the general conditions of his offer when signing the Contract.

Guarantee shall also be for replacement and repair of part or whole of the equipment which may be found defective in material or workmanship. The grantee shall cover the duration of Maintenance Period as defined in the conditions of the Contract. This guarantee shall not relieve the Contractor of his obligations and he will fully be responsible for the repair or replacement of any defective material in time, so as not to cause any undue delay in carrying out the repairs and/or replacements.

The Contractor shall acquaint himself fully with the existing conditions and limitations at site and all works necessary to complete the project under the Contract, to be carried out by the Contractor.

7.0 EXCEPTIONS TO SPECIFICATION

Any exception or deviation from this specification or the codes and standards shall be listed separately in the Contractor's "List of Deviations". Any exception, which shall not be listed, shall not be considered later.

8.0 AVAILABILITY OF SPECIFICATIONS, DRAWINGS AT SITE

The Contractor shall assume at his own cost the permanent availability of this specification and drawings on site where applicable.

9.0 DISCREPANCIES IN TENDER DOCUMENTS AND DRAWINGS

The Contractor shall carefully examine the documents and drawings and if he finds any discrepancies or omissions from the specifications, bill of quantities or drawings, or is in doubt as to the meaning, he shall at once notify the Owner or his representative for receiving his instructions before proceeding with the works. If such defective or modified work is carried out by the Contractor on his own, he shall rectify the same at his own cost.

10.0 MEASUREMENT OF WORKS

The quantities set out in the bill of quantities are the estimated quantities and they shall not be taken as actual and correct quantities of work to be executed by the Contractor. The Contractor shall carry out actual measurement of works at the site.

11.0 INSTALLATIONS DETAILS

The locations, routings, installation heights, detail etc. for electrical equipment are indicated on the drawings. If any information is not stated on the drawings or wherever modifications are required the Contractor shall obtain prior instructions from the Owner or his representative.

12.0 DRAWINGS AND DATA

The Contractor shall provide dimensional outline drawings, arrangement drawings and technical data for the equipment offered, for the approval of Owner or his representative.

13.0 PRIOR APPROVAL OF SHOP DRAWINGS, MATERIALS AND EQUIPMENT

The Contractor shall provide shop drawings for the electrical installations showing the exact routes of all underground cables and ducts, the exact run of all conduits and trunking, draw-in and junction boxes, the number and size of wires in each conduit, the final connection arrangements at distribution boards and the details of ducts for the approval of consultant / Owner's representative before commencing any portion of the works. All such working drawings shall be submitted in suitable number of copies as indicated in the particular conditions and within the periods stipulated below:

a. Cable entry ducts into buildings:

Working drawings shall be submitted within two weeks of handing over the site.

- b. All other working drawings shall be submitted to the Engineer against signed receipt and dated within two months of signing the Contract. Should however the Contractor be obliged to install electrical conduits prior to this period then he shall submit the relevant working drawings at least two weeks prior to the proposed date of commencement of the work. The Contractor shall submit the program indicating the dates on which coordination in different sections will take place, together with the submission of the working drawings. The Engineer shall arrange to return to the Contractor at least one week prior to the commencement of concreting of the section, his comments or approval of the working drawings.

The Contractor shall supply detailed specifications, dimensional drawings, etc., of equipment that he proposes to supply and install.

Where this Contract requires the approval of Engineer to material and goods, the Contractor must seek to obtain this approval within eight weeks after signing of the Contract. No extension of time will be granted for non-availability of material or goods if this clause is not complied with. Approval of the Engineer does not relieve the Contractor of placing his orders in due time for the materials he needs to complete the Contract on time. The approved samples shall be retained on site for comparison with commodities used in works and removed when no longer required.

14.0 MATERIAL ORIGIN AND QUALITY

The material and equipment shall be purchased from Consultant / Owner's agreed suppliers.

The consultant / owner shall retain the right to at any time demand the indication of origin of the materials, and to eventually refuse products, the origin of manufacturing of which have not been previously agreed to without consideration of quality.

On specific agreement of the Owner, the materials may be delivered progressively to the field, but in such a manner as to allow sufficient time for their reception.

When choice of manufacturer is allowed for any particular commodity the Contractor shall obtain the whole quality required to complete the work from one manufacturer or obtain approval of any change in source of supply. He shall produce written evidence of sources of supply when requested to do so by the Engineer.

15.0 IDENTIFICATION OF EQUIPMENT

For each piece of equipment, identification label shall be fitted in front of the casing. The label shall have block letter 7mm high, black on white back ground of trifoliate and fixed with screws.

16.0 MARKINGS

The contractor shall provide "Danger Boards "and" Shock Charts "wherever required to comply with the requirements of local Electricity Rules and according to normal practice.

17.0 FACTORY TESTS

All equipment supplied by and installed as part of the Contract such as distribution boards and like shall be fully tested at the manufacturer's works to the requirements of appropriate standards called for later in the particular specification.

The Contractor shall inform the Engineer in writing about the date and time of test of each equipment at least two weeks in advance. The witnessing of test by the Owner or his representative shall not absolve the Contractor from his responsibility for the proper functioning of the equipment and for furnishing the guarantees referred to in Clause 6.0. All test results in the form of certificate of test / test record certificates, signed by all the witnesses, for each item in the scope of Contractor's supply shall be supplied to the Engineer within seven days of the test date, and in any event before delivery to the site.

All expenses for carrying out the tests and witness by the Owner or his representative shall be borne by the Contractor and deemed to have been included in the tender bid.

18.0 STORAGE

The Contractor shall store the equipment in such conditions that it can not be damaged, i.e., in a dry warehouse. As particular concerns; fragile components, these shall be stored on shelves in their original packing, fitted with identification labels so as to avoid unnecessary manipulation or handling.

The Contractor shall handle, store and fix each commodity in accordance with the manufacturer's recommendations. He shall inform the Engineer if these conflicts with any other specified requirement and submit copies of manufacturer's recommendations to the Engineer when requested to do so.

19.0 LABOR AND STAFF OF CONTRACTOR

The Contractor shall provide / furnish and arrange for:

- Skilled and unskilled labor required for performing the works in accordance with the technical specifications and drawings within the agreed time schedule.
- Supervisory technical staff with appropriate experience and requisite expertise to ensure quality of work performed.

- Supervisory administration and clerical staff to ensure smooth functioning of the activities at site.
- Construction equipment, meggers, tools, etc.

The Contractor shall supply all labor, materials and equipment necessary for the installation of low voltage distribution boards, cables, lighting and power equipment, together with all other apparatus shown on the drawings and as detailed in the Particular specification.

20.0 SMALL INSTALLATION MATERIAL

The Contractor shall supply all small installation and consumable materials such as nuts, bolts, washers, shims, angles, leveling materials, insulation tape, solder, PVC strap-on or heat shrinkable type cable tags, cable ties, bushes, sealing compound, Avometer, electrical testing and measuring instruments, etc., and all such other material not listed in BOQ, required for complete installation as intended by the specification and scope of works.

21.0 INSTALLATION INSTRUCTIONS - GENERAL

The Contractor shall set out the works himself as per specifications and drawings and shall properly position the equipment on specified foundation / location. In general, the manufacturer's instructions for installation shall be followed. Any defect or faulty operation of equipment due to Contractor not following the manufacturer's instructions shall be corrected and repaired by the Contractor at his own cost.

22.0 ASSOCIATED CIVIL WORKS

The expression 'Associated Civil Works' shall mean civil work to be carried out by the Contractor under the direction of the Engineer in connection with the Electrical Service.

The Contractor shall prepare accurate drawings giving details of all holes, fixings, bases and other civil work requirements and shall be responsible for their accuracy. The cost of preparing shop drawings shall be considered to have been so specified in the tender price.

The following is a summary of the work to be carried out by the Contractor:

- a. The cutting and forming of holes for conduits or pipes, or conduit or pipe fixings through walls, floors, ceilings, partitions, roofs, etc., and making good after the work is sufficiently advanced.
- b. The building of concrete and / or brick ducts in floors, walls, etc.
- c. The formation of concrete bases, etc., for equipment
- d. Excavation forming for underground services of ducts and courses and then covers it.
- e. The cutting or forming of chases, recesses, etc., in floors, walls, etc., for conduits and fittings in and making good.
- f. Excavation for and laying of cable carrying pipes.
- g. The building in of brackets and supporting bars or other form of conduit or pipe suspensions.
- h. The painting of all pipes, tube and conduits etc. after fixing unless specified to the contrary.
- i. The providing and building in of sleeves through slabs and walls.

In general all required holes through walls, floors and beams for pipes and ducts will be left out by the Contractor during the process of building.

Where conduits, pipes or fittings are fixed to concrete or woodwork by means of saddles or clips, the Contractor shall himself execute the work necessary and the cost of such work shall be considered to have been so specified in the price.

Cutting, fitting, repairing, patching or plastering and finishing of carpentry work shall be done by craftsmen skilled in their respective trades, when cutting is required it shall be done in such a manner as not to weaken structure, partitions or floors. The holes required to be cut must be directed without breaking out around the holes. Where patching is necessary in finished areas of building, the Engineer shall determine the extent of such patching or refinishing.

23.0 TESTING – GENERAL

Upon completion of installation, at least seven days notice is to be given of intention to perform any test. The Contractor shall perform all static, semi-dynamic (by simulation), and dynamic field testing on all the equipment and systems.

All tests shall be conducted in the presence of the Engineer for the purpose of demonstrating equipment or system compliance with specifications. The Contractor shall submit for Engineer's approval complete details of tests to be performed describing the test procedure, test observations and expected results.

The Contractor shall furnish all tools, instruments, test equipment, materials, etc., and all qualified personnel required for the testing, setting and adjustment of all electrical equipment and material including putting the same into operation.

All tests shall be made with proper regard for the protection of the personnel and equipment and the Contractor shall be responsible for adequate protection of all personnel and equipment during such tests. The cost of any damages or rectification work due to any accident during the tests shall be the sole responsibility of Contractor.

The Contractor shall record all test values of the tests made by him on all equipment. Four copies of all test data and results certified by the Engineer shall be given to the Engineer for record purposes. These shall also include details of testing method, testing equipment, diagrams, etc.

The witnessing of any tests by the Engineer does not relieve the Contractor of his guarantees for materials, equipment and workmanship, or as any obligations of Contract.

In addition to installation testing, the Contractor is to carry out operation testing of all sections and is to clean, set, calibrate and fully commission, demonstrate and hand over to the Owner the entire Contract works in a thoroughly complete and operational state to the satisfaction of the Engineer.

The acceptance - provisional or final- shall be made by the Owner. This reserves him the right to be represented or assisted by a representative or an organization (whether official or not) of his choice, which may decide on his behalf any repairs deemed necessary resulting from lack of observations of this specification, or of the rules and standards. In addition, he may judge the quality of the works and the materials supplied.

This remains in force in case of sub-contracting.

The Contractor shall formally engage his direct responsibilities to the Owner or his representative, and likewise, shall assume all responsibility for work performed by sub-contractors and materials he has supplied and installed.

23.1 Insulation Resistance Test

Insulation resistance test shall be made on electrical equipment by using a megger of 1000 volts for circuits between 250 and 500 volts. The insulation resistance of distribution boards, cables, etc., shall be as per IEC, IEEE, BSS and Pakistan Electricity Rules.

The distribution boards shall be given an insulation resistance measurement test after installation, but before any wiring is connected. Insulation tests shall be made between open contacts of circuit breakers, switches and between each phase and earth.

If the insulation resistance of the circuit under test is less than specified value, the cause of the low reading shall be determined and removed. Corrective measures shall include dry-out procedure by means of heaters, if equipment is found to contain moisture. Where corrective measures are carried out, the insulation resistance readings shall be taken after the correction has been made and repeated twice at 12 hours interval. The maximum range for each reading in the three successive tests shall not exceed 20% of the average value. After all tests have been made, the equipment shall be reconnected as required.

23.2 Earth Resistance Test

Earth resistance tests shall be made by contractor on the earthing system, separating and reconnecting each earth connection as may be required by the Engineer. If it is indicated that soil treatment or other corrective measures are required to lower the ground resistance values, the Engineer will determine the extent of such corrective measures.

The electrical resistance of the E.C.C. together with the resistance of the earthing lead measured from the connection with earth electrode to any other position in the completed installation shall not exceed one ohm.

Earth resistance test shall be performed as per Electrical Inspector's requirements. Where more than one earthing sets are installed, the earth resistance test between two sets shall be measured by means of Resistance Bridge Instrument. The earth resistance between two sets shall not exceed one ohm.

23.3 Switchgear

Each circuit breaker shall be operated electrically and mechanically. All interlocks and control circuits shall be checked for proper connections in accordance with the wiring diagrams given by the manufacturer.

The Contractor shall properly identify the phases of all switchgear and cables for connections to give proper phase sequence.

Trip circuits shall be checked for correct operation and rating of equipment served. The correct size and function of fuses, disconnect switches, number of interlocks, indicating lights and alarms shall be in accordance with approved manufacturer drawings. Nameplates shall be checked for proper designation of equipment served. Protective relays shall be tested and set at site prior to commissioning of the equipment.

23.4 Special Systems Tests

The special systems such as telephone, intercom, etc., shall be tested according to the procedures laid down in the respective sections of the technical specifications. However, any specific tests recommended by the manufacturer shall also be carried out as approved by the Engineer.

23.5 Complete Tests

After any equipment has been tested, checked for operation, etc., and is accepted by the Engineer, the Contractor shall be responsible for the proper protection of that equipment so that subsequent testing of other equipment do not cause any damage to the already tested equipment.

24.0 ELECTRICAL CONNECTION

Electrical connection for each building shall be supplied by other but necessary arrangement coordination to be done by this Contractor.

25.0 SHOP DRAWINGS/ AS BUILT DRAWINGS AND SERVICE MANUALS

A record shall be kept both in hard and soft copies as the work proceeds of any work not in accordance with the working drawings, and upon completion of the work, the Contractor shall prepare the following drawings and forward them to the Engineer for approval:

- a. Duplicate prints of as built single line diagram of the main and sub main distribution network, indicating all cables, their size and type, and the rating of all protection devices such as circuit breakers, fuses, etc.
- b. Duplicate prints of asbuilt/shop drawings of Lighting, Power, Telephone, Data, Fire Alarm, Public Address,CCTV, Access Control, and QueueManagement systems,as applicable.
- c. Duplicate prints of as fixed control and wiring diagrams for the equipment installed as part of the Electrical Contractor works.

After these drawings have been approved, the Contractor shall supply two prints on paper of each and insert these in the operating and maintenance manual specified below.

The Contractor shall submit to Engineer for approval a sample of manufacturer instructions for installation, testing, commissioning, operation and maintenance manuals including manuals of spare parts and tools of the equipment. Upon acceptance, the Contractor shall supply three copies to the Engineer for forwarding to the Owner. These manuals should be in properly bound form. At least two copies of the documents shall be submitted in original. The installation instruction shall be submitted two weeks prior to commencement of installation of each equipment, and operation and maintenance instruction at the time of commissioning. If the Contractor fails to provide the documents, the Engineer shall withhold issuance of requisite certificates and deduct suitable amount from the payments to the Contractor.

26.0 WORK COMPLETION

The Contractor shall further make good, repair, replace all defective works and clear away on completion and leave all installations in perfect working order and to the satisfaction of the Owner or his representative.

27.0 PAYMENT

No separate payment shall be made for work involved within the scope of this section unless specifically stated in the Bill of Quantities or herein.

SECTION - E - 2
LOW VOLTAGE SWITCHBOARDS / DISTRIBUTION BOARDS

1.0 GENERAL

1.1 Purpose

This section together with its appending document covers the minimum requirement for the design, construction and performance of factory built assemblies of LV switchboard.

1.2 Scope of Work

The work under this scope consists of supplying, installation, testing, connecting and commissioning of all material and services of the complete switchboard as specified herein and/ or shown on the Tender Drawings and given in the Bill of Quantities.

The Contractor shall discuss the electrical layout with the Engineer and coordinate at site with others for exact route, location and positions of electrical lines and equipment.

1.3 Standards

Switchboards shall comply with Section - E - 1, Clause 3.

Particular reference shall be made to:

IEC 60027	Letter symbols to be used in Electrical technology.
IEC 60051	Direct setting electrical measuring instruments.
IEC 60073	Colour for indicator lights and push bottoms
IEC 60158	LV Switch gear and control gear.
IEC 60185	Current Transformers.
IEC 60186	Voltage Transformers.
IEC 60269	LV fuses.
IEC 60439	Factory built assemblies of LV switch gear and control gear.
IEC 60529	Degree of protection provided by enclosures.
IEC 60617	Graphic symbols for diagrams.
IEC 60947-2	LV Switch gear and Control gear.
BS 951	Earthing Clamps
BS 1433	Hard drawn bare copper conductor for earthing.
BS 2874	Nuts, Bolts, Washers and Rivets for use on copper.
BS 6346	PVC Insulated Cables.
CP 1013	Earthing

Any other standard referred to in above standards or these specifications.

1.4 Installation and Service Conditions

For general site conditions refer to Section - E- 1, Clause 4.

Switchboard shall be installed indoor. The equipment shall be capable of operation under the prevailing ambient conditions without any deleterious effect of any kind. Switchboard shall be suitable for continuous operation at full load rating under combined variation of both voltage and frequency as stated in Section - E-1, Clause 5.1.

Transient voltage depression down to 80% of rated voltage shall not affect the performance of the equipment and dip voltage must be within permissible limit.

2.0 MAIN ELECTRICAL CHARACTERISTICS

2.1 Power Supply System

Main characteristics of power supply system applicable to all switchboards are:

- Voltage 400 V \pm 10%
- Phase 3 ϕ , 4 Wire.

- Frequency 50 Hz. \pm 2 Hz.
- Neutral system Solidly grounded.
- Peak asymmetrical SCC To be specified by the bidders.
- RMS symmetrical SCC To be specified by the bidders.

Main characteristics of auxiliary supply system are:

- Control / Command system 24 VDC.
- Space heater system 230 VAC.

2.2 Ratings

The equipment shall be capable of carrying the specified current on a continuous basis of 24 hours / day, without exceeding the permitted temperature.

The current ratings of all equipment must be guaranteed at the specified design temperature. Equipment shall be fully rated and constructed for withstanding, making and breaking the specified short circuit duty.

Pins of auxiliary circuits shall be sized for a rated circuit of 10 Amp. Minimum.

3.0 GENERAL REQUIREMENTS

3.1 Concept

The Switchboard shall be of standard, prefabricated metal clad cubicle(s), floor mounting type, totally enclosed, dead front, dust tight and vermin proof requiring front access only. It shall complete in all respects with material and accessories, factory assembled, tested and finished all according to the specifications and to normal requirements. For indoor installations the international classification shall be IP42.

The Switchboard with all components and accessories shall be suitable for front operation only and shall:

- have a rated service short service breaking capacity, Ics at 400 VAC, conforming to IEC 60947-2 unless otherwise stated on the drawings.
- be provided with adequate clearance from live parts so that flash over cannot be caused by switching, vermin, pests, etc.
- have all components rated for insulation class 600-volt minimum.
- be designed for flush mounting of all instruments on the front side.
- have all incoming or outgoing connections from the top or bottom as required. Have the components mounted so as to facilitate ease of maintenance from the front. Have common lamp test facility for all lamps.
- have wiring diagram on the inside of door of the switchboard. Be labeled with nameplate on the front side of door.
- have arrangements for extension of switchboard in future.

3.2 Accessibility

Switchboard shall preferably be arranged for bottom cable entries. Adequate space must be provided for cable entries and termination. It shall be possible to work easily and safely on cable of a main or control outgoing circuit in OFF position with the remainder of the board alive.

Adequate system shall be provided for installation and clamping of cables inside the cable compartment. Position of terminals and cables shall allow use of clamp ammeter.

Power and Control cable termination shall avoid obstruction to other cable termination and provide easy access for terminating cables. Cable supports shall be provided to avoid undue strain on cable termination. Easily accessible locations shall be reserved in the compartment for measuring transformers.

3.3 Heaters

Space heaters shall be provided for prevention of moisture in each cubicle. Heaters shall be wired together and shall be automatically controlled to avoid over heating the equipment. Heater shall be suitable for operation on 230 VAC supply from an external source (to be provide in main Distribution Board)

3.4 Name plates

On the front side, a name plate shall be provided at the top to indicate the name of manufacturer, system voltage and frequency and the current carrying capacity of switchboard.

Each breaker shall have a circuit identification label fitted below the breaker aperture or as suitable.

Drawing indicating the branch circuit names, breaker elements, cable sizes and connecting services shall be placed in a clear plastic pocket provided at the back of the front access.

Labels described shall have block letters 7 mm high on a white back ground, to be made from traffolite and be fixed with screws.

Each incoming and outgoing circuit shall also be labeled with name plate 75 mm x 15 mm, as described above on the front side of door.

4.0 MECHANICAL DESIGN

4.1 General Construction

The switchboard shall be fabricated, welded; grinded, finished with angle iron framework and clad with 14 SWG MS sheet, to form a rigid, free standing, flush mounting fronted assembly.

It shall be suitably divided into panels and compartments for accommodating the required number of circuit components, instruments and accessories. Each compartment shall be fully partitioned from its neighbor both horizontally and vertically, allowing safe cable routing / termination without shutting the switchboard down.

All live parts within cubicles, compartments or modules, which have to accessible during normal maintenance operations, shall be adequately protected and / or barred to ensure protection of works and to avoid accidental contact. Barriers may be rigid, transparent, insulating material fitted with warning labels.

The doors shall be provided with hinges on the left-hand side and locking handles on the right hand side for fastening the door. The front assembly shall be fastened to the enclosure by means of self locating fasteners for quick and easy fixing.

All holes, cutouts shall be tool or jib manufactured and free from burrs and rough edges. All structural components shall be of standardized design to provide complete uniformity and inter change ability of common parts. Removable gland plated shall be provided at top and / or bottom as required.

The switchboard shall be supplied complete with foundation bolts and other installation materials as recommended by the manufacturer. Proper size cable clamping channels with galvanized steel clamps and brass cable clamps respectively for unarmoured and armoured cables shall be provided.

The cabling inside the Switchboard shall be suitably numbered and harnessed by means of straps or cords. Wiring to door mounted components shall be in flexible PVC conduit. All indicating, control and selecting equipment shall be suitably arranged and clearly labeled with indelible labels indicating the rating of fuses, switches, etc.

All metal work of the switchboard shall be cleaned down to bare shining metal, phosphate and the surfaces chemically prepared for powder coating. Then these shall be coated with powder of colour RAL 7032 and then baked in oven. The thickness of powder coating shall not be less than 120 microns.

4.2 Bus Bars

Bus bars and droppers supported on non - hygroscopic material are to be high conductivity electrolytic tinned copper, completely isolated and mechanically braced and rated to withstand the specified short circuit currents for one second duration.

Bus bars and droppers shall be housed in a separate compartment and shall be clearly marked with their respective colors. Bus bars shall be provided for three phases, neutral and multi - terminal earth. The temperature rise shall not exceed 50 degree centigrade at rated current. Neutral bus assembly shall consist of outgoing screw terminals with one terminal for every MCCB / MCB.

Neutral Bus bar should be of same ampere rating as phase bar.

Removable metal covers on the bus bar chamber shall be provided with suitably sized labels at regular intervals, fixed with self tapping screws and warning of live metal work.

All bus connectors shall be tinned plated connections and joints. Horizontal bus bars shall be of the same current rating throughout their length.

4.3 Earthing

A copper earth bar of suitable section for the specified fault level shall extend the entire length of the Switchboard. Provisions shall be made for possible future extensions at both ends.

Earthing facilities shall be provided on each incoming and outgoing unit to permit earthing of the connections.

All metallic non-current carrying parts of the Switchboard shall be bonded together and connected to the Switchboard's earth bar.

Each circuit wiring shall be green / yellow colour. Earthing mass continuity between withdrawable parts and fixed frame shall be correctly ensured whatever the withdrawable part position.

Provision shall be made adjacent to cable termination for earthing cable armour to the earth bus bar.

Earthing switch shall be provided wherever mandatory as per rules and regulations / codes and standards and shall be manually operated. An interlocking system shall provide the following locking and safety functions:

- Impossibility of closing the earth switch if the switching device is closed.
- Visual check of earthing switch positions to be possible.
- Possibility of locking the earthing switch operating handle in open and closed position.
- The earthing of the bus bar shall be done manually by the operator without provision of general earthing system.

5.0 DISTRIBUTION BOARDS

The enclosure of the LV Distribution Board shall be fabricated from electro-galvanized / zinc coated sheet steel.

The LV Distribution Board shall be fabricated with 16 SWG sheet steel recess mounting. All components shall be installed on a common component mounting plate made of 14 SWG sheet steel inside the enclosure and protected from the front with screwed sheet steel front plate. The door and dead front covers shall be made of 14 SWG sheet steel. The door shall be fully gasket with hinges on the left hand side and locking handle on the right hand side for fastening the door. The locking handle should be detachable. The dead / front assembly shall be fastened to the enclosure by means of self - locating fasteners for quick and easy fixing.

The distribution board shall be supplied complete with all installation materials as recommended by the manufacturer. The incoming and outgoing cable connections shall be according to the wiring requirements. If required, an adapter box for accommodating the cables and conduits may be provided. The box shall be of the same material and finish as the Distribution Boards.

An earth bar or terminal strips shall be provided for connection of incoming and outgoing earth conductors. The earth bar or terminals shall be permanently connected to the body of Distribution Boards at two points. Flexible copper strip shall be provided for earthing of the door of Distribution Board.

Neutral bus assembly shall consist of out going screw terminals with one terminal for each MCB. All holes, cutouts, etc., shall be tool or jib manufactured and free from burrs and rough edges. Removable gland plates shall be provided at both the top and / or bottom, as required.

The cabling inside the distribution board shall be suitably numbered and harnessed by means of straps or cords. Wiring to door mounted components shall be in flexible PVC conduit. All indicating, control and selecting equipment shall be suitably arranged and clearly labeled with indelible labels indicating the rating of fuses, switches, etc.

All metal work of the distribution board shall be cleaned down to bare shining metal, phosphate and the surfaces chemically prepared for powder coating. Then these shall be coated with powder of colour RAL 7032 and then baked in oven. The thickness of powder coating shall not be less than 120 microns.

6.0 COMPONENTS

The switchboards shall be provided with all components as specified or shown on the Drawings and as necessary for the satisfactory operation of the Switchboard and of the electrical system. All components should comply with IEC 60947-2. Typical specifications are given hereunder:

6.1 Air Circuit Breaker (ACB)

Air circuit breaker should be draw out type with three poles / four poles as mentioned in drawing suitable for making and breaking a fault condition. Operating mechanism shall be manually or motor operated charged spring with front drive grip handle. These shall be locally operative. Mechanically operative ON-OFF-OFF indicators positively driven in both directions shall be provided to indicate the position of the unit.

Overload and over current features / relays shall be of an adjustable, manually resettable type, according to manufacturer's standard range.

Each ACB shall have built in tester with the selection of Trip or Non-Trip Functions. Also with the facility of testing the ACB in field from single phase (220VAC) supply only. Each of the above function shall have separate LED Indicators and Alarm switches for trip monitoring of Overload, Short circuit, Pre trip alarm and Ground Fault. ACB shall be having Trip Memory.

The Breaking Capacity of ACB shall be 65KA. ACB breaking capacity shall be; $I_{cu}=I_{cs}=I_{cw}$.

The circuit breaker shall have two normally open and two normally closed auxiliary contacts rated for 10 Amps. 230 VAC. The circuit breaker shall also provide for ON-TRIP-OFF indicating lamps. The circuit breaker shall have specified rupturing capacity without the use of back-up fuses. Auxiliary release and trip coils shall be provided for desired operation and / or interlocking as shown and / or stated on the Drawings.

6.2 Moulded Case Circuit Breaker

These shall be three pole 400 / 500 volts rating shown on the drawings. The breakers shall have both time delay over current and instantaneous short circuit protection.

The MCCBs shall be installed such that their switching levers are accessible through the dead front plate for operation. Circuit numbers / designation on all circuits shall be conspicuously marked to facilitate connection and maintenance.

The breaker shall have quick make - quick break toggle mechanism with positive 'ON', 'OFF' and intermediate ' Tripped ' positions.

Trip mechanism shall be trip free on overload or short circuit ensuring that the breaker will not close / remain close even if the close command is given while the circuit breaker has tripped due to short circuit or continuing overload.

6.3 Miniature Circuit Breaker (MCB)

The MCBs with current rating from 3 to 80 amperes shall be conforming to BS EN 60-898 or IEC 60947-2. The circuit breakers shall be suitable for DIN-rail mounting, maintenance-free and fully tropicalized.

The MCBs shall be designed for horizontal or vertical mounting, or reverse feeding, without any adverse effect on electrical performance.

The operating mechanism shall be quick make, quick break type, trip free, with all poles opening and closing simultaneously (except for the neutral pole, which if required shall be of the advance-closing and late-opening type). The operating toggle shall clearly indicate the ON and OFF/TRIP positions.

The individual operating mechanism of each pole of a multiple MCB shall be directly linked within the MCB casing and not by the operating handle.

Each pole of the MCBs shall be provided with bimetallic thermal element for overload protection and a magnetic element for short circuit protection.

6.4 Earth Leakage Circuit Breakers (ELCB)

ELCBs shall be four pole, current operated type with tripping current of 0.3A and tripping time not more than 0.1 seconds.

6.5 Load Break Switches

Load Break Switches and contactors shall be of AC3 type for motor loads. Air circuit breakers above 630A shall be housed in separate cubicles. Aluminium plate shall be provided for cable entry to ACBs / MCCBs cubicles of 630A and above rating.

6.6 Air Break Contactor (ABC)

The contactors shall be air break, triple pole, 400 / 500 VAC and suitable for the type of duty to be performed. The main contacts shall be silver tipped, butt type with double break per pole. Each contactor shall be provided with single phase 230 VAC operating coil and minimum one spare normally open and one normally closed auxiliary contact. The number of working auxiliary contacts shall be provided according to the system requirements.

7.0 POWER FACTOR IMPROVEMENT PLANT

The power factor improvement plant shall be used for improving the power factor of the system. The plant shall be automatic-cum-manual.

The power factor improvement plant shall be aligned with main LT switch board and it shall be a part of that LT switchboard as shown on the drawing. The capacitors shall be suitable for three phases, 415 volts 50 Hz system and shall be self cooled, designed for indoor use in tropical climate for maximum ambient temperature of 45 degrees centigrade and relative humidity 90%. The capacitors shall be in the form of banks divided for 12 stages, 6 stages and 4 stages. Each capacitor bank unit shall be 25 and 50 KVAR. The total KVAR capacity shall be as indicated on the drawings. Each capacitor unit shall be complete with discharge resistors and internal fuses and shall be connected with control panel with proper size of single core PVC insulated cables.

The panels shall be supplied complete with a set of 3-phase, full capacity, isolated tinned copper bus bars, interconnections, risers, designation labels, cable sockets, holding down bolts, wiring with cleats and ferrules, earthing sockets and studs, etc. Each control panel shall comprise.

1 No. Multi stage power factor correction relay for automatic/manual control.

1 No. 3-phase, 4 wire, 415 volts, unbalanced load power factor indicator.

1 No. Auto-off-Manual selector switch

1 No. Current transformer with 5 amps secondary current, having suitable output burden and accuracy.

3 Nos. Instrument protection fuses.

7.1 Requirement of Capacitor Banks

According to IEC-83 1 -1 and 831-2.

Fully insulated, terminals to be shielded by a cover.

Dielectric: Plastic poly-propylene, impregnated.

Electrodes: Aluminium coating vacuum metalized.

Safety features: Self healing. Over pressure tear-off fuse.

Withstand switching operations safely.

Maximum in rush current 200 times rated current.

Loading capacity: 1.1 times rated voltage. 1.3 times rated current at delta max.

Overloading capacity 1.5 times rated output at delta max.

Acceptable tolerances - 5/+ 10% of rated output at rated frequency.

Static life expectancy > 100,000 operating hours.

Test Specifications: Terminal versus terminal with an AC voltage 2.15 times rated voltage for 10 seconds duration. Terminals to casing with an AC voltage of 3 KV for 10 seconds duration.

8.0 PARTICULAR COMPONENT REQUIREMENTS

8.1 Current Transformers

Current transformers shall comply with the requirements of IEC 60185 (or equivalent).

Current Transformers shall be polyester resin insulated, ring type, air cooled having transformation ratio as indicated on the drawings. The current Transformers shall be of suitable burden having accuracy class 1.0. The Current Transformers shall have rated secondary current 5A / IA as required.

Current Transformers shall mechanically and thermally withstand the specified short circuit capacity. Test terminal blocks shall be provided for current Transformer secondary circuits having short circuiting provisions to allow portable apparatus to be connected.

8.2 Voltage Transformers

Voltage transformers shall comply with the requirements of IEC 60186 (or equivalent) and shall be of the same accuracy class as Current Transformers.

Voltage Transformers shall be equipped with primary fuses with an interrupting capacity of the incoming circuit breakers. Test terminal block shall be provided for each Voltage Transformer system.

8.3 Ammeters and Voltmeters

Indicating instruments shall be semi-flush Switchboard type, moving Iron, spring controlled with standard scale having white background and black graduations and markings. The front dimensions shall be 144 x 144 mm for instruments on incoming side and 96 x 96 mm on all outgoing circuits.

Indicating instruments shall be 1.0 class percent of full scale basic accuracy class in accordance with IEC 60051.

The ammeter shall be suitable for connection to 5 Amp. Secondary of Current Transformer or directly through shunt as shown on the drawings. The instruments shall have measuring range indicated on the drawings. A red mark shall be provided at the working voltage on the scale of all voltmeters.

8.4 Selector Switches

Ammeter and voltmeter selector switches shall be complete with front plate, grip handle, R-Y-B and OFF position for ammeter and RY-YB-BR-RN and OFF positions for voltmeters.

The selector switches for controls shall be rotary cam type and shall be provided complete with knob and front plate, showing all positions as required.

8.5 Push Buttons

The push buttons shall be momentary make / break contact type (normally open / normally close) and suitable for flush mounting. The push button for ON and OFF switching shall be red and green respectively.

8.6 HRC Fuses

HRC Fuses shall be provided complete with fuse bases, fuse, etc. The fuses shall have a fusing factor as specified for class QI in accordance with BS 88.

8.7 Pilot Lamps

Switchboard shall be provided with phase indicating pilot lamps. The lamps shall be rated for 250 volts supply and suitable for flush mounting. The front of the lamps shall have colored rosettes for identification of phases.

8.8 Line up Terminals

Line up terminals wherever provided for Control or Power circuits shall be suitable for voltage and size of conductors as indicated on drawings. The Line up terminals for controls shall be suitable for channel mounting. All necessary accessories such as end-plates, fixing clips, transparent label holder caps and label sheets with marking shall be provided.

8.9 Secondary Wiring

All wiring shall be copper conductor, thermoplastic insulated, at least 1.5 sq. mm flexible, neatly arranged and clipped in groups.

Each conductor and its termination are to be identified and marked with numbered ferrules. All live terminals are to be shrouded.

Secondary wiring for Current Transformers shall be carried out with not less than 2.5 sq. mm. Terminals shall be specially marked to avoid opening of the circuit by accident.

9.0 INSTALLATION

The LV Switchboard shall be installed at location shown on the drawing. The Contractor shall ensure coordination with civil works for providing any openings, holes, etc. to avoid any breakage to completed works. In case the provisions in civil works for the installation of electrical equipment are not made or made incorrect the same shall be rectified by the Contractor at his own cost and to the satisfaction of the Engineer. The Contractor shall provide foundation bolts and grout them in cement concrete floor using non-shrinkable material with the approval of Engineer.

All installation material for physically erecting the Switchboard, such as bolts, nuts, washers, supporting steel, etc., shall be provided and installed by the Contractor. The Switchboard shall be installed upright and in level and shall be firmly and rigidly bolted to the floor and concrete supports.

The switchboard shall be completely erected as per manufacturer's instructions and as approved by the Engineer. Loose parts dispatched by the manufacturer shall be installed and connected as per assembly drawing provided by the manufacturer. Any safety locking provided by the manufacturer for safe transportation shall be released only after the switchboard is erected in position.

The incoming and outgoing cables shall be connected as recommended by cable manufacturer. The cable armour shall be connected effectively to ground.

The Switchboard body shall be connected to earth as per instructions given in section "Earthing" of these specifications. The Switchboard shall be tested and commissioned in the presence of the Engineer. The tests to be carried out shall be tested before energizing as per instructions contained in the article " Testing " of General Specifications of Electrical Works, section E-1 of these specifications.

SECTION - E - 3 LOW VOLTAGE CABLES AND WIRES

1.0 SCOPE OF WORK

The work under this scope consists of supplying, installation, testing, connecting and commissioning of all material and services of low voltage cables and wires and the accessories as specified herein or shown on the Tender Drawings and given in the Bill of Quantities.

The Contractor shall discuss the electrical layout with the Engineer and coordinate at site with others for exact route, location and positions of electrical lines and equipment.

The LV cables and wires with accessories shall also comply with the General Specifications for Electrical Works, Section E- I and with other relevant provisions of the Tender document.

2.0 GENERAL

All multicore and single core wires for light circuits, socket outlets and circuits operating upto 250 volts shall be 300 / 500 volts grade. All single core sheathed cables shall be of 450 / 750 volt grade and upto 50sqmm and above shall be of 600/1000V. Power cables for main feeders, main to sub main feeders, power equipment, etc., armoured or unarmoured shall be of 600 / 1000 volts grade.

Armouring of cables shall be done with appropriate size galvanized steel wire as per codes.

The conductors shall be stranded or solid, high conductivity, soft annealed copper. Conductor of single core cables shall be circular, whereas of multicore cables may be circular or shaped according to standard practices and codes. The PVC insulation shall be extruded with a PVC compound having good flexibility, resistance to aging and ability to withstand the ambient temperatures as given in General Specifications for Electrical Works, Section E-1 of these specifications. Cable should be capable of running 125% of full load current without any damage.

3.0 STANDARDS

LV Cables and Wires shall comply with Section – E -1, Clause 3.

Particular reference shall be made to:

BS 6004 / 6346	PVC insulated cables for lighting and power.
BS 6746	PVC insulation for electrical cables.
BS 6360	Copper conductors
BS 6500	Insulated flexible cords.

Any other standard referred to in above standards or these specifications.

4.0 MATERIAL

4.1 General

The power, lighting and control cables shall be furnished and installed in accordance with the routes and requirements shown on the drawings.

All cables shall have phase identification colours on insulation of each core. The colour code for three phase circuits shall be red, yellow and blue for phase conductors and black for neutral conductor. Where insulated earth conductor is installed, it shall have green colour insulation.

Single phase circuits shall have insulation of red colour for phase / line, black colour for neutral and green colour for earth conductor.

All DC circuits shall have insulation of red colour for positive, black colour for negative and green for earth conductor.

The ends of each length of multicore armoured or unarmoured cables shall be properly marked for clock-wise and anti clock-wise sequence of core colors.

4.2 Cables for Conduit Wiring

All cables / wiring in concealed or surface mounted PVC or steel conduits shall be single core PVC insulated of specified grade and size, unless specifically shown on the drawings or given in BOQ.

4.3 Cables on Surface / Concrete Trenches

Cables for distribution system to be installed on surface, in cable ducts, in concrete trenches or on trays shall be single or multicore PVC insulated and PVC sheathed of specified voltage grade and size, unless specifically shown on the drawings or given in BOQ.

4.4 Underground Installation

Cables for laying directly underground shall be PVC insulated, PVC sheathed and armoured with galvanized steel wire. Cables fully installed in underground ducts / pipes and mechanically protected from end to end shall be PVC insulated and PVC sheathed unless specifically shown on the drawings or given in BOQ.

4.5 Cable Accessories

All cable accessories shall be provided for the complete cabling and wiring system without any additional cost unless specifically mentioned in BOQ. These shall include but not limited to the items such as saddles, clamps, fixing channels, connectors, cable joints (where necessary and approved by the Engineer), clips, lugs, tapes, solder, identification tags, bushes, glands, etc.

5.0 INSTALLATION

5.1 General

When the laying is effectuated by others, the contractor shall test the cable characteristics insulation and continuity, at all phases of these and communicate them in a report to the Engineer, as per recommendations of the standards according to which the cable is manufactured.

The cables shall be spaced by categories along their entire length as well as upon penetration into buildings and in their interiors, according to their following rated voltages:

- 30 cm at least between a cable carrying 1 KV - 30KV and other cables.
- 20 cm at least between a cable carrying voltages between 50V - 500V, and any power or control 10 cm at least between a cable carrying voltages lower than 50V and telephone or these possible being grouped.

All installation material, labour, tools and accessories for cable installation shall be furnished by the Contractor. The cable and accessories shall be installed as described in accordance with these specifications, drawings and manufacturer's instructions.

5.2 Conduit Wiring

The wiring through conduit shall be started only after the conduit system is completely installed and all outlet boxes, junction boxes, etc., are fixed in position. The filling rate inside the conduits shall not exceed 50 %. Cables directly embedded in the masonry are not accepted.

The wires shall be pulled in conduit with care, preferably without the use of any lubricant. Where necessary and if approved by the Engineer, the cable manufacturer's recommended lubricant may be used. Where several wires are to be installed in the same conduit, they shall be pulled together along with the earth conductor. All wires of same circuit shall be run in one conduit.

The wires shall not be bent to a radius less than 10 times the overall diameter of the wire, or more if otherwise recommended by the manufacturer.

The wiring shall be continuous between terminations and looping-in system shall be followed throughout. Any joint in wires shall not be allowed. The use of connectors shall only be allowed at locations where looping-in is rendered difficult. The consent of the Engineer shall be required for using connectors. The connector shall be of suitable rating having porcelain body with sunk-in screw terminals. The connector shall be wrapped with PVC insulation tape after its installation. A minimum of 150 mm extra length of cable / wire shall be provided at each termination to facilitate repairs in future.

5.3 Cables on Surface / Trenches

All cables for installation on surface of wall, column, ceiling, trenches, etc., shall be fixed to the surface by means of galvanized steel clips, secured to a steel channel using suitable stud plate, nuts and washers.

The erection of cables and position of support shall be agreed by the Engineer on site, having taken into consideration the accessibility of all such routes. These shall be so arranged that cable crossing one another be minimized if cannot be avoided.

Cables shall be fixed throughout their length by means of approved saddles, clips, etc., at every 600 mm vertically and 900 mm horizontally.

Cables and equipment fixed to a building fabric, i.e., brickwork, concrete, etc., shall be fixed by means of appropriate fixing devices, i.e., Raw bolts, Hilti fixing devices, etc., or alternatively by means of suitable fixing devices cast at site, e.g., concrete inserts.

Contractor shall be responsible for all drilling of steel work, brick work and masonry where necessary for fixing clamps and brackets for supports.

Cables shall not be pulled into conduit until the conduit system has been completed, cleared and free from obstruction and sharp edges.

It shall be ensured that conduit system is clear before cable is drawn in. cables shall be put into conduits in such a manner that there will be no cuts or abrasions in the cable insulation, protective braid and jackets. There shall be no link in the conductors.

Distance of saddles shall be used for installation of cables in defined condition of the surface of wall etc.

Grease or other injurious lubricants shall not be used in pulling cables. The use of talc or non-injurious lubricants is permissible, if desirable.

The number of wires installed in any conduit shall be such that the resulting space factor does not exceed 50 %. Spliced wires shall not be pulled through conduits.

All conduit wiring shall be carried out in the loop - in principle from outlet box to outlet box and in no circumstances shall joints be used except in fixed base connection blocks housed in outlet boxes.

The vertical clearance between two adjacent cables at any point is 50 mm minimum. Common mounting, channels are to be furnished for cable along the same route. The Contractor can offer alternate cable fixing arrangement, which shall be approved by the Engineer before commencement of installation.

The wall crossings where the outdoor cables penetrate in the building shall be carefully obstructed by means of polyurethane foam. The Contractor shall be fully responsible for the perfect tightness of these cable penetrations.

5.4 Underground Cables

The Contractor shall plan and take special care to prevent any damage to existing underground facilities such as underground piping, cables, foundations, etc. The Contractor shall notify the Engineer of any obstruction encountered and shall provide protective support or removal of such obstructions as instructed by the Engineer. Excavation adjacent to existing facilities, such as foundations manholes, ducts, underground pipelines and paving shall be braced and / or shored properly to protect those facilities during excavation and construction.

Sufficient slack shall be left in cables for this purpose that cut lengths of cables shall allow about 3% more in the measured lengths between terminations.

Cables, whether installed underground or in concrete trenches, shall not be bent to a radius less than 10 times the diameter of the cable or as recommended by the cable manufacturer, whichever is higher.

All cables shall be marked at least at each end, switch gear and equipment termination, where cable enter or leave underground cable trenches or channels, where cable rises from one level to another, at 30M intervals with predetermined identification numbers, by means of proprietary non-deteriorating type, PVC, heat shrinkable, strap-on type or equivalent, for the identification of cable and circuit. These shall be indelibly marked with cable number and securely fixed to the cable. Where conductors are left to be terminated by another party or left to be connected later, they shall be identified. The earth continuity conductor shall be laid in the trench with the cables.

Cables entering the buildings shall also be laid in protective pipes. The protective pipe ends, after installation of cables, shall be plugged water tight by means of polyurethane foam / bituminized Hessian or equivalent method as approved by the Engineer.

5.5 Cable Termination and Joints

Cables shall be terminated in a safe, neat and approved manner at the associated equipment, included that erected by others.

Compression type connectors (lugs) shall be of the correct size and approved type for the conductors concerned. Compression tools shall be supplied for specific use and shall be maintained in good order. After compression the conductor and terminal shall form a solid mass ensuring good conducting properties and mechanical strength. The compression jointing system used throughout the installation must be approved by the Owner or his representative before use.

The Contractor shall be responsible for all drilling and if necessary, tapping entries where these have not been provided by others.

When preparing cables prior to fitting glands, the gland manufacturer's instructions for cable preparation shall be observed. In all cases where armoured cables are used, care shall be taken to ensure that the lay of the armour is maintained after the gland is completely fitted.

Termination and joints shall be suitably insulated for the voltage of the circuits in which they are used.

Every compression joint shall be of a type, which has been the subject of a test certificate as described in BS 4579.

Cable ends, which are not terminated immediately after cutting, shall be sealed effectively to prevent ingress of moisture and shall be protected from damage until termination.

For all cables above 6 sq. mm in section, if a substantial mechanical clamp is not provided a compression type lug or socket shall be provided. At all equipment, cable shall be installed and terminated so that no strain is imposed on the cable or gland and due allowance made to counter the effect of vibration. At all termination an ample length of 'tail' shall be left.

Where joints in cable conductors and bare conductors are required, they shall be mechanically and electrically sound and they shall be accessible for inspection. Joints in non-flexible cables shall be made either by soldering or by means of mechanical clamps or compression type socket, which shall securely retain all the wires of the conductors.

Any joint in flexible cable shall be effected by means of cable coupler. Cable couplers and connectors shall be mechanically and electrically sound and shrouded in metal, which can be earthed. Where the apparatus to be connected require earthing every cable coupler shall have adequate provision for maintaining earth continuity.

Cables of AC circuits, installed in PVC or steel conduit shall always be so bunched that the cables of all phases and the neutral conductor (if any) are contained in the same circuit. The outdoor apparatus shall normally be connected by means of cables with conduit termination down to about 30 cm below ground level or concrete foundation. The conduit shall be firmly secured down to their penetration into the trench or channel.

SECTION - E - 4 CONDUITS AND PIPES

1.0 SCOPE OF WORK

The work under this scope consists of supplying, installation and commissioning of all material and services of the complete Conduits and Pipes as specified herein and / or shown on the Tender Drawings and given in the Bill of Quantities.

The Contractor shall discuss the electrical layout with the Engineer and coordinate at site with others for exact route, location and positions of electrical lines and equipment.

The Conduit and Pipes with accessories shall also comply with the General Specifications for Electrical Works, Section E- I and with other relevant provisions of the Tender document.

2.0 GENERAL

The extent of works shown on the drawing does not indicate the exact position of conduit and pipes. The Contractor shall ensure exact location and route of conduit and pipes in coordination with other services drawings, as per site requirements and as directed by the Engineer.

The quality and material for the accessories of conduits and pipes such as sockets, elbows, bushings, bends, inspection / pull boxes, round boxes, etc., necessary for the completion shall be similar to that of conduit or pipes. All the accessories shall be supplied by the Contractor without any extra cost and deemed to have been included in the price of conduits / pipes.

3.0 STANDARDS

Pipes and Conduits shall comply with Section - E-1, Clause 3.

Particular reference shall be made to:

BS 31	Steel Conduit and accessories
BS 1378	Galvanized Iron Pipes and accessories.
BS 3595	PVC Pipes and accessories.
BS 4607	PVC Conduits and accessories.

Any other standard referred to in above standards or these specifications.

4.0 MATERIAL

4.1 PVC Conduits, Pipes and Accessories

The PVC conduits and accessories for lighting and power circuits shall be furnished by the Contractor as shown in the drawings or given in BOQ. The PVC bends shall have enlarged ends to receive conduit without any reduction in the internal diameter at joint. Manufactured smooth bends shall be used where conduit changes direction. Bending of conduits by heating or otherwise will be allowed in special situations only, for which the consent of the Engineer shall be required. The use of sharp 90 degree bends and tees will not be allowed for concealed wiring.

The round PVC junction boxes for ceiling light or fan points shall have minimum dimensions of 64 mm diameter and 64 mm depth. The junction boxes for wall light points shall have minimum dimensions of 57 mm diameter and 40 mm depth. Round junction boxes shall be provided with one piece bakelite cover plate fixed to the box by means of galvanized screws.

The PVC pipe shall be rigid and shall be minimum D-Class (working pressure - 12 Kg / cm), unless otherwise stated on Drawings or Bill of Quantities. Where pipe changes direction, manufactured smooth bends shall be used. For jointing of pipe, all precautions and procedures recommended by manufacturer shall be followed.

4.2 Steel Conduit and Accessories

All conduits shall be of heavy gauge 16 SWG steel, manufactured and tested in accordance with latest relevant standards.

The conduit shall be protected by two base coats of red oxide anti-rust paint and finished in first quality black enamel paint. The coating shall be of heavy enamel, which shall not flake or crack during installation and handling. Each conduit length shall be furnished with threaded ends and a threaded coupling at one end. Soft metal bushes shall be provided at conduit termination to prevent damage to cable during pulling operation.

Junction boxes shall be 100 mm square, having minimum depths of 38 mm or 65 mm as required for accommodating the number of wires. The junction box shall be 16 SWG sheet steel provided with anti-rust paint and finished in heavy black enamel paint. The cast Iron outlet boxes for light points shall be round having 50 mm diameter and 63 mm depth. The above dimensions are given as minimum only, and the exact size shall be determined by the Contractor keeping in view the ease of Installation and maintenance. All outlet boxes and junction boxes shall be provided with one piece bakelite cover plate of suitable design.

4.3 Galvanized Iron Pipes and Accessories

The G.I. pipes shall be galvanized from inside and outside by hot dip galvanizing method. The pipes shall be free from stains, burrs or any other defect. The accessories for G.I. pipes shall be galvanized from inside and outside. The conduit shall be NPT threaded, with at least 5 complete threads and assembled with TEFLON tape.

4.4 Inspection Boxes / Pull Boxes

The rectangular inspection boxes or pull boxes shall be of 16 SWG heavy gauge, sheet steel having nipples welded to box at entry holes to receive PVC conduit with force fit. The box shall be painted inside and outside with black enamel paint over a base coat of red oxide primer paint. The minimum length of inspection box shall not be less than six times the cable manufacturer's recommended bending radius of the cable. All concealed type pull boxes shall have a white plastic sheet of appropriate size fixed to the box by means of galvanized screws.

4.5 Adaptable Boxes

Adaptable boxes shall be made of 16 SWG sheet steel box, painted and finished to the same quality as the light Distribution Board. The boxes shall be 50 mm in depth for conduits up to 25 mm diameter, 63 mm in depth for conduits up to 40 mm diameter and 87 mm in depth for conduits up to 50 mm in diameter. For conduits more than 50 mm in diameter, the minimum depth shall be two times the diameter.

4.6 Conduit / Pipe Accessories

Bushes, plugs, glands, etc., shall be of brass and all male bushes shall be of long thread pattern. Covers for boxes shall be screw fixed and finished as the boxes. Gaskets shall be fitted only when finish is galvanized unless otherwise specified.

4.7 Cable Trunking

Where required, wiring shall be run in hot-dipped galvanized (after fabrication) sheet steel cable trunking of the specified gauge complete with all fittings and accessories, manufactured and installed in accordance with BS 4678/NEMA. The trunking shall be constructed with return flanges. Trunking covers shall be secured by anchored turn-buttons and locking bars and minimum length of individual sections shall be 2.44-m. The trunking shall be suspended/supported from the structure at maximum 2-m intervals with straps and hangers fabricated from minimum 6-mm dia HDGF bars, or supported by angle-iron brackets.

Conduit drips from the trunking shall also be supported with hangers. Factory made connectors shall be used at joints.

Junctions (tee and 4-way) in multi-compartment trunking shall be double depth to avoid reduction in cabling space. Cable in vertical runs shall be supported by pin racks, prongs or bridging pieces. Fire barriers shall be provided at each floor level. Allowance for expansion shall be incorporated.

Bonding links shall be provided at each joint and secured by screws, nuts and shockproof washers. The bonding links shall make contact with the metal of the trunking of fitting, and continuity shall not depend on contact through the screws, nor on removal on site paint finish from ferrous metal.

5.0 INSTALLATION

5.1 PVC Conduits - Concealed

The conduit shall be installed concealed in roof, wall, column, etc.

At all joints and bends, PVC jointing solution as manufactured by Pakistan PVC Limited or approved equivalent must be used to strengthen and to seal the joint.

Manufactured smooth bends shall be used. Bending of conduits by heating or otherwise will be allowed in special situations only, for which the consent of the Engineer shall be required. The use of 90 degree bends and tees will not be allowed.

The conduit shall have a minimum of 38 mm cover of concrete. In the reinforced cement concrete (RCC) work, the conduit shall be laid before pouring of concrete. Under no circumstances shall chases be made in the RCC structure for concealing conduit and accessories, after pouring of concrete. The conduit shall be supported on top of bottom reinforcement of slab and shall be firmly secured by tying to the reinforcing steel in order to avoid being disturbed during pouring of concrete.

All outlet boxes to be firmly supported and installed such that they finish flush with the soffit of slab or beam.

Where conduits have to be concealed in cement concrete (CC) work after concreting, or in block masonry, chases shall be made with appropriate tools and shall not be made deeper than required. The conduit shall then be fixed firmly in the recess and covered with cement concrete mixture to have to at least 32 mm cover before plastering. The work of curing in the cement concrete work or block masonry work shall be coordinated with the civil work. The Contractor shall obtain approval from Engineer for the route, to suit the site conditions before starting chasing and cutting.

The termination of conduits at or near the Switchboard / Distribution Board is shown diagrammatically on the drawing. The exact final locations of the termination shall be coordinated with the Switchboard / Distribution Board to be installed. Any extension of conduit near the Switchboard / Distribution Board to suit the site condition shall be made without any extra cost. Conduit ends pointing upwards or downwards shall be properly plugged in order to prevent the entry of foreign materials. All openings through which concrete may leak shall be carefully plugged and boxes shall be suitably protected against filling with concrete. At all termination of concrete, soft bushes shall be fixed to prevent sharp edges of conduit ends from cutting or damaging the wires or cables to be pulled through them.

The entire conduit system shall be installed and tested before wiring is carried out. Any obstruction found shall be cleared by use of cutting mandrel or other approved device and the conduit shall be cleaned out before the installation of cable.

Pull boxes / Adaptable boxes shall be provided in conduit runs wherever required to facilitate pulling operation. The drawings are diagrammatic and do not indicate the position and spacing of pull boxes or adaptable boxes. However, these shall meet the following requirements:

- Pull boxes.
For straight runs the spacing shall not be more than 30 meters.
For runs with one 90 degree bend, the spacing shall not be more than 15 meters.
- Adaptable boxes.
For conduits up to 25 mm diameter, the boxes shall be 50 mm in depth.
For conduits up to 40 mm diameter, the boxes shall be 63 mm in depth.
For conduits up to 50 mm diameter, the boxes shall be 87 mm in depth.

Wherever the conduit lengths cross the expansion joint either along the column or slab, suitable arrangement shall be provided so that when the conduit lengths in the expansion joint are stressed, the conduit neither develops any cracks nor breaks down.

Bending, off setting and similar operations shall be performed through the help of proper bending tool to give a perfect bend of required angle without Desha ping of conduit to the least.

5.2 Steel and G.I Conduit

The minimum size of conduit shall be 20 mm.

The use of solid or inspection elbows, bends or tees will not be permitted and 120 degree bends shall be limited to one between any two drawn-in boxes.

Conduit coupling joint shall not be used where conduit enter spout entry boxes. Conduit running, joints shall not be used where conduit enter conduit boxes or spout entry boxes.

Equipment that is required to be removed for maintenance shall be provided with conduit unions in all conduits that enter such equipment. The use of conduit nipples shall be avoided as far as practicable.

All conduits shall be cut square and reamed at the end. All conduit ends and the inside of conduits shall be clean and free from burrs.

Where bushed spouts or tapped holes are not provided at conduit termination, the conduit shall be terminated in a flanged socket and a smooth bore brass hexagon bush, with a lead washer fitted between the flanged socket and the equipment or box.

All exposed threads and parts where the galvanizing has become damaged shall be thoroughly cleaned and painted with galvanized paint. The exposed conduit ends shall be capped to protect threads from being damaged before installing cables.

Repair painting shall take place before any making good on site or buildings is carried out. The entire conduit system shall be checked for continuity. Any observation found shall be removed without damaging the installation.

The conduit system shall be installed empty with an 16 SWG steel wire drawn through the conduits for pulling of cables. Joints in underground conduits shall be avoided or reduced to the absolute minimum.

Where adjustable dies are used they shall be so adjusted that threads cut with them shall be the same depths as machine made threads.

The use of manufactured bends shall be avoided and instead smooth bends shall be provided by using approved type of bending tools.

Flexible steel conduits shall be installed at all points locations where flexible connection is required, as directed by the Engineer. The flexible conduits when used, shall be protected by external PVC sheath, resistant to oil damages.

G.I. pipes for underground installation shall be given bituminous paint coating and wrapped with suitable paper or cloth before installation.

5.3 Fixing of Conduits and Fittings

Conduits in process units and on steel work with "U" bolt type fixings.

Conduits in buildings shall be fixed with galvanized distance saddles. Where a number of conduits follow a single route they may be fixed to mild steel brackets.

Conduits shall be supported on both vertical and horizontal runs as follows:

- Conduits size 20 mm and 25 mm maximum spacing of fixing 1000 mm.
- Conduit sizes larger than 25 mm spacing of fixing 1500 mm.

All conduit boxes that support fittings shall be securely fixed. All conduits shall be fixed 150 mm before and after every right angle or off set. All conduit fittings and equipment shall be fixed true and line able.

All conduit bends shall be made with an approved conduit bending machine or hickory. The radius of curvature of the inner edge of any bend shall not be less than the following table:

Conduit size	Radius
20 mm (3/4")	Not less than 130 mm.
25 mm (1")	Not less than 150 mm.
32 mm (1-1/4")	Not less than 200 mm.
38 mm (1-1/2")	Not less than 255 mm.
50 mm (2")	Not less than 305 mm.
70 mm (2-1/2")	Not less than 380 mm.
82 mm (3")	Not less than 460 mm.
100 mm (4")	Not less than 610 mm.

Under ground conduit stud-up or kick pipe through concrete envelope shall be extended a minimum of 150 mm above grade and adequately braced to prevent shifting during concrete pouring work. The concrete envelope shall extend at least 76 mm above grade. Under floor conduit installation shall be at a minimum depth of 120 mm from finished floor level. The G.I. pipes / conduits shall be installed at a minimum depth of 1000 mm measured from the top of size to the finished road level.

5.4 Location of Conduits and Fittings

Before conduits are installed, confirmation shall be obtained that the conduit may be installed in that position.

Particular attention shall be given to the location of conduits to prevent the infringement of headroom and access ways.

Conduits shall be located to avoid obstructions, furnaces, hot lines and other places of high temperature.

Conduit shall not be located than 150 mm (6") where it runs parallel to or crosses hot surfaces. Underground conduit runs shall be kept to minimum in both number and length. Conduits shall not be recessed in fair brick work.

Draw boxes shall be so positioned to enable the cables to be drawn in easily. The boxes shall not be located in the comers or other such locations and shall be positioned to avoid tight bends, bending and cable kinks.

Conduits shall not generally be installed having a greater length 12,000 mm (40 feet) between draw-in boxes.

Conduit entries shall wherever possible be located in the bottom of boxes and equipment etc.

SECTION - E – 5 WIRING ACCESSORIES

1.0 SCOPE OF WORK

The work under this scope consists of supplying, installation and commissioning of all material and services of the complete switches, switch sockets, etc., and miscellaneous items as specified herein and / or shown on the Tender Drawings and given in the Bill of Quantities.

The Contractor shall discuss the electrical layout with the Engineer and coordinate at site with others for exact route, location and positions of electrical lines and equipment.

The wiring accessories shall also comply with the General Specifications for Electrical Works, Section – E - I and with other relevant provisions of the Tender document.

2.0 GENERAL

The locations of the wiring accessories such as sockets, switches etc. are tentatively shown on the drawings. The Contractor shall ensure exact positions and locations of wiring accessories in coordination with other services drawings, as per site requirements and as directed by the Engineer. The Contractor shall be responsible for proper functioning of wiring accessories after installation and Commissioning.

3.0 STANDARDS

Wiring accessories and miscellaneous items shall comply with Section - E-1, Clause 3. Particular reference shall be made to:

- BS 67 Ceiling roses.
- BS 1363:1984 13A fused plugs and un-switched socket outlets
- BS 116 Two and three terminal ceiling roses.
- BS 2135 Capacitors for radio interference suppression
- BS 3676 Switch for domestic and similar purposes.
- BS 4934 Safety requirements for electric fans and regulators.
- BS 5060 Performance of circulating fans and their regulators.

Any other standard referred to in above standards or these specifications.

4.0 MATERIAL

4.1 Switches

Switches for controlling light and fan points shall be single pole, rated for 10 Amp, 250 VAC. The body of switches shall be made of poly carbonate / urea with white face plate suitable for flush mounting on sheet steel outlet box. The switches shall be gang type having silver tipped contacts and operate with snap action.

For locations where switches and fan speed regulators are installed together, single switches shall be grouped and fixed on 3 mm thick plastic sheet screwed to a sheet steel box of appropriate dimensions. The fixing of plates on outlet boxes shall be means of flat head counter sunk galvanized screws with the head of the screw finish flush with the surface of the plate. Except for switches controlling light points, all single switches for fans, sockets, etc., shall have identification symbols on the operating levers.

Two way switches shall be used to control lights from two different locations as shown on the drawings.

4.2 Switch Socket Outlets

Switch socket units shall be of flat pin type and conform to BS 1363, 13A for fused plugs and socket outlets. 2 and 3 Pin rated for 5 Amps. or 2 Pin rated for 5 Amps. Supply as specified in the bill of quantities.

3 Pin 5 Amps. Sockets shall be moulded type having white plastic face plate, suitable for mounting on a sheet steel box of appropriate dimensions. Switch sockets shall have shrouded live contacts such that the earth pin is engaged to socket earth before making with the live contacts. Where specified, the switch socket unit shall have spring loaded dust tight cover for mechanical protection.

4.3 Sheet Steel Boxes

The outlet boxes for installation of switches, fan speed regulators and socket outlets shall be 16 SWG sheet steel having appropriate dimensions. The boxes shall have suitable knockouts or welded nipples for receiving the conduits. An earth terminal shall be provided for connecting at least three earth wires of 4 sq. mm. The outlet boxes shall be given two coats of anti-rust red oxide and one coat of enamel before installation. The boxes shall be suitable for mounting flush with the surface of wall or on the surface of wall as may be required. The boxes shall not be less than 75 mm x 75 mm (3" x 3"). All boxes shall be water tight where installed in the vicinity of liquids.

4.4 Ceiling Rose

The ceiling rose shall be suitable for 5 Amps. 250V AC. It shall have white plastic moulded base plate, copper or brass terminals for connecting at least two wires of 2.5 sq. mm size. The ceiling rose shall have a cover with cable inlet hole for multicore PVC insulated and PVC sheathed cable.

4.5 Fans

4.5.1 Bracket Type

The bracket type fans shall be suitable for mounting on the wall and suitable for operation semi-horizontally. These shall operate satisfactorily on 250 volts, single phase, 50 Hz, A.C. supply with + 10 % tolerance.

The sweep of the fan shall be as given in BOQ/drawings.

The fans shall comply with BS 380 as far as constructional requirements, range of fan speed regulator, starting, radio interference, silent operation and temperature rise are concerned. For testing, BS 848 as amended shall be complied with.

4.5.2 Exhaust Fan

The exhaust fans shall be three blade types, mounted on the steel/plastic structure of its own, which will be fixed to the structure by means of suitable grouted foundation bolts. The fan shall be suitable for operation on 250 VAC with + 10 % tolerance.

The sweep of the fan shall be as given in Schedule of Quantities/drawings. Fans shall be direct driven and supplied complete with electric motor, back draft dampers and anti-vermin screen. The bearings shall be ball, roller or sleeve type of permanently lubricated and sealed type. Wheels shall be heavily and rigidly constructed and accurately balanced both statically and dynamically and free from objectionable vibration or noises.

The fans shall comply with BS 380 as far as constructional requirements, range of fan speed, speed regulator starting, radio interference silent operation and temperature rise is concerned. For testing BS 848 as amended 1 960 shall be complied with.

5.2.3 Ceiling Fans

The ceiling fans shall be suitable for hanging from the ceiling. These shall operate satisfactorily on 250 volts, single phase, 50 Hz, A.C. supply with + 10 % tolerance.

The fans shall comply with BS 380 as far as constructional requirements, range of fan speed regulator, starting, radio interference, capacitor size, silent operation and temperature rise are concerned. For testing, BS 848 as amended shall be complied with.

SECTION - E – 6 INTERIOR LIGHTING FIXTURES

1.0 SCOPE OF WORK

The work under this scope consists of supplying, installation and commissioning of all material and services of the complete light fixtures as specified herein and / or shown on the Tender Drawings and given in the Bill of Quantities.

The Contractor shall discuss the electrical layout with the Engineer and coordinate at site with other services for exact route, location and positions of light fixtures.

The light fixtures with accessories shall also comply with the General Specifications for Electrical Works, Section - E-1 and with other relevant provisions of the Tender document.

2.0 GENERAL

The description of light fixtures in given Bill of Quantities, and stated on the drawings, and relevant material are described in this section. The determination of quality is based on certified photo-metric data covering the coefficient of utilization, light distribution curves, construction material, shape, finish, operation, etc.

The Contractor shall submit two samples of each and every light fixture specified and obtain approval of the Owner before purchasing. The quality and finishes of local make light fixtures (if mentioned in BOQ) shall be same as that of standard manufacturer. The accessories such as ballast, lamp / starter holders, starters, lamps, ignitors, etc., for all type of light fixtures shall be of Philips make.

All fixtures shall be finished in standard colour schemes as mentioned in the manufacturer's catalogue for respective fixtures, unless specifically stated in the Specifications, Drawings or Bill of Quantities or directed by the Engineer.

3.0 STANDARDS

Lighting fixtures shall comply with Section E-1, Clause 3.

Particular reference shall be made to:

- IEC 81 Tubular fluorescent lamps.
- IEC 82 Ballast for tubular fluorescent lamps.
- IEC 155 Starters for fluorescent lamps.
- IEC 400 Lamp holders and starters holders for fluorescent lamps.
- IEC 566 Capacitors for use in TL, HP Mercury and LP sodium vapour.
- IEC 598 Luminaries.
- BS 3677 Discharge lamp circuits.

Any other standard referred to in above standards or these specifications.

4.0 MATERIAL

4.1 Fluorescent Light Fixtures

The fluorescent light fixtures shall have lamps and ballast of proper rating as shown on the drawings. Each lamp shall be provided with independent ballast.

The fluorescent lamps shall be tubular, 1224 / 610 mm long, for TL 28 / 14 watts respectively as specified. The fluorescent colour shall be warm white characteristics with an average output of 3350 lumens (+5%) for 28 watts and 1350 lumens (+5%) for 14 watts after 1 00 burning hours. The ballast shall be electronic type for 28 / 36 watts ballast. A wiring, diagram, wattage, voltage and current figures shall be printed on the body of the ballast.

The lamp holders shall be rotary lock-in type. The starters shall be glow type with radio interference suppressor / by-pass capacitor. The internal wiring of the fluorescent light fixtures shall be done with heat resistant wires at the manufacturer's factory. All light fixtures shall be provided with power factor improvement capacitor to give a minimum power factor of 0.90.

The body of the fluorescent light fixtures shall be minimum 22 SWG sheet steel, derusted, degreased, finished in heat resistant paint, stove enameled. Appropriate size bushed wire entry holes, fixing holes and earth terminals shall be provided. Connectors suitable for connecting 2.5 sq. mm cable connectors shall be provided for supply connections. An earth terminal for connection to 14 SWG copper conductor shall be provided.

The light fixtures shall be furnished with perpex diffusing panels " 040 opal acrylic" (minimum sheet thickness 3 mm), polystyrene louvers or metal grid louvers or mirror optic reflectors, etc. as specified on the drawings or in BOQ. The louvers shall be secured firmly and in level. The polystyrene louvers shall be white Egg Crate or as approved. The louvers shall be in one section and not in pieces.

The design of light fixture for recess mounting shall be coordinated with the design of false ceiling prior to commencement of manufacture. Shop drawings shall be submitted for approval of Engineer.

4.2 LED Light Fixtures

The light fixture shall be as stated on drawings and bill of quantities. The light fixture shall be finished in standard colors unless otherwise stated on drawings or directed by Engineer. All LED light fixtures shall be of international standard and quality. The type of fixtures with manufacturer catalogue reference is given on the fixture schedule and in Bill of Quantities. Equivalent fixture may be acceptable provided that the Contractor submits for review all necessary data indicating photo-metric curves to show that the fixture proposed are of the same type, construction and quality.

The lamps for light fixtures shall be Light Emitting Diodes with driver and shall be supplied and installed according to the wattage as indicated on drawings.

Weather proof light fixture shall comprise of cast aluminum body and gasketed clear glass cover secured to the body by means of galvanized nuts / screws to give a weather proof and water tight fit. The gasket shall be weather resistance type.

The LED light fixtures shall be supplied complete with driver and all accessories as per light fixture schedule and shall be installed in accordance with manufacturer's recommendations and sound engineering practice.

5.0 INSTALLATION

5.1 General

The mounting heights of light fixtures are indicated on the drawings, and position of fixtures according to the mentioned scale.

The Contractor must ensure that the light fixtures are installed uniformly with respect to the dimensions of the area. Any modifications due to site conditions may be made with the approval of Engineer. All fixtures shall be carefully aligned before fixing in position. All fixing accessories such as ceiling rose, flexible cord, lamp holder, suspension rod; pipe or chain with suitable canopy, etc., shall be provided and installed.

The wiring between terminal box and the fixture shall be carried out with 3 core 0.75 sq. mm and 1 sq. mm copper conductor, PVC / PVC cable respectively for circuits protected by 10 amps and 15 / 20 amps MCBs. The wiring inside light fixture body shall be done with heat resistant cables or PVC insulated cable in heat resistant sleeves as approved by the Engineer.

Glasses, shades, reflectors, diffuses, etc., must be in a clear condition after installation.

All light fixtures shall be earthed by an earth wire connected to the earth terminal in the fitting.

5.2 Fluorescent Light Fixtures

The fluorescent light fixtures on the surface of ceiling shall be installed with the back of the body flush with the ceiling surface, and in a manner so as to facilitate wiring. Nylon plugs and galvanized steel bolts or screws shall be used for fixing the light fixture to the ceiling. For light fixtures on installation on false ceiling, the installation method detail shall be coordinated with ceiling design and submitted for approval of Engineer. Care shall be taken to prevent the weight of the fixture from being transferred to the false ceiling.

Pendent light fixtures shall have two holes in the top of each casing by a 1/4" diameter galvanized pipe or any other standard method as approved by the Engineer. Wiring from ceiling rose to the fixture shall be installed through the pipe. Proper arrangements such as long threads with check nuts, etc. for minor adjustment in the mounting heights of the fixtures shall also be provided.

5.3 LED/CFL Light Fixtures

The LED and CFL light fixture shall be installed on the surface of ceiling or wall by means of nylon plugs and galvanized steel screws, such that their back finish flush with the surface for exposed conduits and flush with outlet box for concealed conduit system. Wherever convenient, screws for fixing light fixtures shall be screwed into the holes of the outlet box. The light on false ceiling shall be installed in accordance with manufacturer's recommendations and in coordination with ceiling installation.

5.4 Outdoor Lighting

For illumination around buildings during dark hours, light fittings in various arrangements shall be provided in accordance with these specifications. The items not shown on drawings or called for, but which are necessary for a complete working system as required, these shall also be provided and deemed to have been considered as such.

The Contractor shall essentially use the standard products of a manufacturer, regularly engaged in the manufacture of the product and shall meet the requirement of the specifications.

SECTION - E – 7 ADDRESSABLE FIRE ALARM SYSTEM

1.0 SCOPE OF WORK

The work under this scope consists of supplying, installation and commissioning of all material and services of the complete Addressable Fire Alarm system as specified herein and / or shown on the Tender Drawings and given in the Bill of Quantities.

The Contractor shall discuss the electrical layout with the Engineer and coordinate at site with other services for exact route, location and positions of the system.

The Fire Alarm system with accessories shall also comply with the General Specifications for Electrical Works, Section E- I and with other relevant provisions of the Tender document.

2.0 STANDARDS

The latest editions of the following standards / codes shall be applicable for the materials covered within the scope of this specification:

BS 5839, EN approved
NFPA 72

Any other standard referred to in above standards or these specifications.

3.0 OPERATION

The Fire Alarm System shall be analogue addressable type complete with battery standby power. MFACP have provision to monitor/interfaced with client area FACP for full proof monitoring.

At locations indicated in the drawings the break glass type fire alarm Control Panel, Repeater Panel and automatic detectors shall be installed. In case of any Fire, the manual station shall be operated by pulling down the handle or breaking glass. The actuation of this station shall cause an audio as well as visual alarm at the fire alarm control and indication unit, duly indicating the location of the respective station/zone.

An authorized person shall immediately visit the effected area and if after investigating, it is deemed necessary, alarm in the whole building shall be initiated from either the alarm switch located beside the fire alarm control panel by inserting a special key or the actuation of any indication at the Fire Alarm Control Panel. The general alarm shall be initiated by an authorized person after inspecting the affected location.

Circuit shall be so arranged that an open circuit in an initiating or indicating loop shall cause the individual zone and common trouble indication at the fire alarm control panel.

4.0 MATERIAL

4.1 Conduit and Conduit Accessories

The specifications for conduit and conduit accessories shall be same as given for electrical conduit in Section E - 5 of these specifications.

4.2 Fire Alarm Cable

Fire Alarm Cable shall be 2 core 1.5mm shielded twisted pair, fire resistant, PVC insulated 250/440 volts grade cable to be laid in concealed PVC conduit.

4.3 Power Supply

The supply and operating voltages shall be 220 volts, 50 c/s and 24 volts D.C. respectively. The control stations shall be provided with sufficient capacity nickel cadmium battery with charger to operate the complete system for the least 3 hours in case of mains failure.

4.4 Fire Alarm Control and Indication Unit

The fire alarm control and indication unit shall be a Solid State Modular Unit consisting of the following Modules; suitable number of modules shall be used to provide facility for 6 loops. It shall not be possible to remove the key without turning the key to its normal position, thus resetting the alarm contacts.

i. Loop Module

Loop Module shall have multiple of supervised initiating circuit with a trouble and an Alarm Lamp for each loop. Detection circuit wiring shall be two wire Class `A' and shall power all Detectors (Relay outputs and) voltage output for each zone alarm and voltage output for each zone trouble shall be provided.

ii. Audible Expander Modules

Audible Expander Modules shall provide for supervised control circuit for polarized alarm signaling devices. Loop activated lamp shall be provided for each loop to aid on system testing and trouble- shooting provide (1) (2) (3) indicating circuits.

iii. Power Module

Power Module shall supply the necessary power for the loop module and all Detectors (and shall contain a Battery Charger to charge the batteries) An AC power to Lamp shall be provided to indicate the normal condition of the panel. Individual supervisory lamps shall be provided for AC power failure indication, ground fault detection, and low battery. All controls shall be behind a key-locked door to prevent unauthorized operation. Two supervised control circuits for audible signaling shall be provided as part of this module. Common trouble and common alarm relay and logic outputs shall be provided. The panel cover shall be key-locked to prevent unauthorized access.

4.5 Addressable Manual Break Glass Station

The break-glass manual station shall be operated by pulling down on the handle. When operated, the handle shall remain down with the pre-signal alarm contacts closed until the station is reset. The general alarm contacts shall remain open until after investigation. The general alarm switch shall be operated by an authorized person with a special key.

4.6 Addressable Audible Signal Unit

Fire alarm sounder with strobe shall be red color surface mounted installed where indicated on the drawings. Sound intensity shall be such that an audible signal will be heard clearly throughout the structure when the entire bells ring. The bell shall be connected in multiple cross loop conductors.

4.7 Addressable Smoke Detector:

The Smoke Detector is optical type and shall be connected to the specific loop. Base shall be provided with detector.

4.8 Addressable Heat Detector:

The Heat Detector is connected to the specific loop. Base shall be provided with detector.

4.9 Annunciator if required

The remote visual annunciator shall have the capacity for indicating 6 distinct alarm loop and one common trouble condition. The annunciator shall be back lighted type to increase visibility and to deter tampering with the lamps. The descriptions of each zone shall be approved by the Engineer Incharge. In the normal condition the annunciator shall have a blank appearance. Alarm and trouble condition shall be annunciated both visually and audibly. Lamp shall be 24 V DC, and replacement shall be readily available. Lamp replacements shall be accomplished without tools.

A test switch shall be provided for periodic testing of all lamps in the annunciator. To reduce tampering the annunciator shall have a key operated silence switch and a key locked cover. For aesthetic reasons the unit shall be compact, have a brushed metallic trim ring and be surface mounted.

4.10 Multi Sensors (Conventional / addressable)

The multi sensors shall incorporate photo electronic optical smoke sensor and high sensitivity thermal sensor and provide early warning from all types of smoldering and thermal fires. The smoke element shall be of the light scattering type using be of the light scattering type using a pulsed internal LED light source and a photocell sensor. The thermal element shall utilize high sensitivity, high speed thermistors optimized to measure small changes in temperature and rate of change. The detector shall be capable of protecting an area up to 100 m² at a height of up to 12 m.

4.11 Function of Addressable Fire Alarm Control Panel (FACP)

i. Design

The FACP shall be solid state, modular design with integral static protection. All indicating lamps shall be long-life, low maintenance solid state light emitting diodes (LED).

ii. Enclosure

The FACP enclosure shall be semi-flush mounted. The enclosure shall be hinged from the left and the cover shall have clear windows and locking mechanism to keep the system operating and status switches from being tampered keys shall be made available to fire department and other authorized operating personnel. Finish shall be "FIRE ALARM RED" and "BLACK".

iii. Loops & Identification

All controls shall be labeled, all loop locations shall be identified, and the FACP shall be provided with a set of permanently mounted operating instructions, to avoid confusion. Loop location identification shall be as approved by the Engineer Incharge and contain up to three lines of text with 1/8" minimum character heights.

iv. Components of Fire Alarm Control Panel

The FACP shall include as minimum following:

- a. All hardware and software to allow the panel configuration and operation to be changed at the panel. Systems that require off-site programming are not acceptable.

The memory data for panel configuration and operation shall reside in non-volatile, memory provided by battery-backed RAM. Removal of the board shall not cause loss of memory contents.

Switches for panel setup, set reset, manual, evacuation alarm, silence and acknowledge. Individual supervisory LEDs shall be provided for power, run, alarm, trouble, disconnect, low battery and ground fault.

- b. Indicating zones: As indicated on the drawings, each zone containing smoke detectors shall provide power and monitoring for up to only 50% detectors. (All hardware and software shall be provided to facilitate selection of circuit performance to provide alarm verification for smoke detector circuits with field false alarms. When a detector signals an alarm, the panel shall automatically reset the detector, wait and their double checks to verify the alarm. Each zone shall have a red LED to indicate alarm and yellow or amber LED to indicate a trouble condition.
- c. Indicating Loops: 1 or 2 indicating circuits shall be provided. Each circuit shall provide power for polarized alarm signaling devices. A red LED to indicate the energized state of the circuit and a yellow LED to indicate a trouble condition shall be provided for each circuit. A disconnect switch for each circuit shall be provided to allow the FACP to be tested with sounding alarm signals. When disconnected, the FACP shall indicate both trouble condition and disconnect.

v. Manual Functions

At any time, even without an alarm condition on an indicating circuit, the operator shall provide the following manual capabilities in the FACP by means of switches located behind a key-locked cover:

- a. In case of fire if a general evacuation is needed all bells shall sound. These signals can be initiated from the main panel and secondary switch at manual fire alarm initiating device (break glass unit).
- b. Silence the local audible signal. This shall also cause the LED(s) to cease flashing and to be continuously 'ON'.
- c. Silence the alarm signals.
- d. Reset the FACP, after all initiating devices have been restored to normal.
- e. Disconnect any individual initiating or indicating circuit from the alarm sequence. This action shall light a disconnect LED and cause a trouble condition.
- f. Perform a complete operational test of the system microprocessor with a visual indication of satisfactory communication with each board.
- g. Test all panel LEDs for proper operation without causing a change in the condition on any zone.

vi. System Supervision

- a. Upon application of primary power, or reapplication following power failure, the FACP shall automatically be in a normal supervisory condition.
- b. In the normal supervisory condition, a green "POWER" LED shall be illuminated, indicating the presence of primary power.
- c. A green "RUN" LED shall be illuminated indicating that the microprocessor is communicating with the system and the memory contents are satisfactory.
- d. The following shall be electrically supervised:

All initiating and indicating device circuits.

All plug-in circuit board shall have proper board type in the position. System that use electrical continuity to supervise the presence of plug boards, but that do not assure that board position have been exchanged, shall provide equivalent means for specified supervision, beyond that provided by the locked cover.

4.12 Shop Drawings / Technical Specifications

Prior to installation of any equipment, the Contractor shall submit for approval, shop drawings including riser and terminal wiring diagrams and specifications data sheets. Submittals indicating typical one line riser and typical specification data sheets only will not be acceptable.

The Contractor shall review the total system point to point wiring layout to assure that the correct number and type of wire and conduit sizes are installed.

Upon completion, the Contractor shall provide detailed written operation instructions and three sets of "as built" drawings including plan, layout, conduit runs and wiring diagrams as finally installed.

4.13 Test

Upon completion and at such time as the Engineer incharge may direct, the Contractor shall conduct a total system test where line supervision and each device shall be tested. All the tests shall demonstrate that the system meets the tests shall operating requirements of this specification, that individual conductors of all circuits are free of grounds, shorts and breaks, and that no grounds exist between any piece of equipment in the control unit and the cabinet. All final connections, testing, adjusting and calibrating shall be made under the direct supervision of a factory trained technician of the system supplier.

4.14 System

The fire alarm control panel (FACP) shall be installed at the Security room at lower ground floor by at a position and height as shown on drawing and as approved at site. The FACP shall match with the wall finish and shall be of neat finish, installed flush or semi-flush with the wall.

The fire alarm riser shall travel in one conduit for straight runs, separate conduit shall be used at branch office through junction boxes.

4.15 Fire Alarm Installation

The Fire alarm system shall be installed as mentioned in the drawings. The system shall be connected, tested and commissioned as per manufacturer's instructions and in the presence of Engineer Incharge. The wall recessed mounting Fire alarm manual stations shall be installed at a height of 4.5' feet above finished floor level. The connections of the appropriate Contactors of the Fire alarm system shall be made as per manufacturer's instructions.

The mounting height of the sounder shall be above the false ceiling or 7' from F.F. level when false ceiling is not comes. The conduit and wiring of the Fire alarm system shall be as per installation instructions for conduits and wirings given in the relevant section of these specifications. The Fire alarm system conduit shall be laid 15 cms (6") from the electrical conduits and cross the electrical conduit at 90 degree only. The Fire alarm system conduit shall be marked with red colour at terminations in order to distinguish it from other conduit system.

SECTION - E – 8
TELEPHONE & DATA CABLING SYSTEM & ACCESSORIES

1.01 WORK DESCRIPTION

- A. This Section specifies the minimum acceptable requirements on the quality, performance and standard for the Telephone Cabling System.
- B. The Contractor shall be responsible for the engineering, supply, installation, testing and commissioning of a cabling system for the complete Telephone System including, lead-in pipes, Local Authority's telecom manholes, cable tray, conduit, intermediate distribution frame (IDF) and telephone wiring between the Telecom riser and the terminal blocks or telephone points in each area.
- C. The Contractor shall install and terminate, where necessary, faceplates, jacks, cables, backboards, connection blocks, hubs, patch panels, patch cords, racks, brackets and all other hardware necessary to meet Local Authority's requirement.
- D. All works shall be performed in accordance with Rules and Regulations of the Local Authority's Guidelines for the provision of Telecommunication Facilities and to the satisfaction of Engineer.
- E. The work shall include all attendance and liaison with the Local Authority for the installation of main distribution frame, running of main cabling and all other telephone equipment.
- F. All equipment shall be current model, no replacement problem of components. All equipment and materials shall be as specified in the contract and to local Authorities acceptance.
- G. The Contractor must be licensed in Tripoli, Libya to carry out the telephone cabling system installation to Local Authority's requirement.

1.02 SUBMISSION

- A. All technical submissions shall be approved by the Engineer prior to the respective stages of construction.
- B. As a minimum requirement, the submission shall include the following:
 - 1. Equipment submission with manufacturer's data.
 - 2. Sample submission including telephone outlets, terminal blocks, cables, etc.
 - 3. Drawings for field equipment showing the co-ordinate routing of cable routings and details on the equipment mountings.
 - 4. Builder's works requirements.

1.03 REGULATIONS

- A. The whole installation shall be engineering and installed in accordance with the Drawing and Specification and also the regulations of the Local Authority having jurisdiction over the installation work.
- B. The Contractor shall co-ordinate with the Local Authority and submit required shop drawing for Engineer's approval prior to work carried out on site.
- C. The Contractor shall co-ordinate with Local Authorities for the inspection and Handling over of the MDF room, Telephone Risers, Telephone Tray to Local Authority's acceptance. All time and cost require to arrange for the inspection and carry out the installation to meet inspection requirement shall be included in the Contract.

- D. All work by the Contractor shall be in accordance with the practices set forth in TIA/E1A 568-A and to Local Authority's requirement.

2.01 TELEPHONE CABLES AND TERMINAL BLOCK

- A. The box shall be of heavy duty uPVC modular type with screwed cover similar to 'Egatube' boxes or approved equivalent.
- B. A flush mounted box with approved terminal block shall be installed as specified on drawings. The terminals block shall be able to accommodate the numbers of pair of the block terminals as specified in the Drawings plus 15 percent spare pair terminals for future connection.
- C. Telephone cable shall be Cat 5E 100 ohm, unshielded twisted pair (UTP) plenum rated with solid copper conductors. The cable provided shall comply with Local Authority's requirement. The numbers of pair shall be as per the Drawing.
- D. The termination of telephone cables to the terminal block shall be carried out by skillful personnel by means of proper tools and links. A neat arrangement with proper labeling shall be provided. The Engineer reserve their right to reject any improper termination and arrangement of cables.

2.02 OUTLET

Outlet compatible with telephone equipment approved by Local Authority shall be provided. Light position 11-style modular jack(s), T568B, with wire caps to provide strain relief and contamination protection, and able to accommodate coloured icons shall be provided to Local Authority's specification

2.03 TELEPHONE CABLES

- A. Telephone cables shall generally be multicore polyvinyl chloride insulated and sheathed cables, unless otherwise specified:
 - 1. Designed for communication use. Final sub-circuit wiring of each telephone outlet shall be provided with two (2) spare wires.
 - 2. Conductor – multi strand annealed copper
 - 3. Insulation – polyvinyl chloride to BS 6746

DATA CABLING SYSTEM

1.01 SCOPE OF WORK

- A. The following specifications are for the installation of the communication and data wiring. The Contractor shall provide all labor and materials for installation of the data communications systems as note on drawings and in these specifications. The Contractor will install and terminate, where necessary, faceplates, jacks, cables, backboards, connection blocks, hubs, patch panels, patch cords, racks, brackets and all other hardware necessary to effect a workable cable plant fully complaint with that as described in these specifications and in the drawings, and to the Local Authority's requirement and to the satisfaction of the Engineer. The contractor shall also submit as built drawings that reflect the installed cable routes, port locations and labeling information.

Section 1.01 1.02 GENERAL REQUIREMENTS

- A. The work shall consist of the following:
 - 1. Provide and install conduit, cable, connectors, wall plates, terminators, pullboxes, patch panels, panel racks/brackets, hubs and other items necessary for a complete working data/communications system. All work by the Contractor shall be in accordance with the practices set forth in TIA/EIA 568-A and comply with Local Authority's requirement.
 - 2. Provide electrical services to support the data systems required under this contract.
 - 3. Construct data communication closets as required to comply with these specifications and to Local Authority's requirement.
- B. Provide As-Built drawings identifying the cable path and note any deviations from the original drawings. Also provide all documentation on label and testing information prior to system acceptance.

Section 1.02 1.03 CONTRACTOR QUALIFICATIONS

- A. The Contractor must be licensed in the Tripoli, Libya to carry out the data cabling system installation to Local Authority's requirement.
- B. All the above information must be provided at the time of the contract award, prior to signing the contract.

Article II.

Article III. MATERIALS

Section 3.01

Section 3.02 2.01 SUBMITTALS

- A. Submit for review by the Engineer a compilation of material specifications to be incorporated in the work. Support submittals by descriptive means, i.e.: catalog sheets, product data sheets, and other literature by the manufacturer.
- B. Acceptable materials and manufacturers are listed below and are used only for reference. Materials and products considered as equivalent by the contractor, other than those listed, shall be submitted for Engineer approval. Submittals shall consist of substantiation of Local Authority's acceptance, catalog pages with items marked, referenced part numbers for which the substitution is intended, with specification sections and paragraphs referenced. In addition, samples of cables, connectors, and wallplates are required to be submitted for approval prior to installation.

- C. Manufacturer's cable markings shall consist of manufacturer's name, cable type/catalog No., 1987 NFPA type code compliance, and the 1993 NEC code compliance.
- D. Make submittals for each of the following items as included in the scope of this work:
 - 1. Horizontal cables
 - 2. Jumper cables
 - 3. Patch cords
 - 4. Connectors
 - 5. Wallplates
 - 6. Conduit, bushings, sleeves, raceway, etc.
 - 7. Patch panels
 - 8. Racks and brackets
 - 9. Hubs

Section 3.03 2.02 STATION OUTLETS

- A. Each communication workstation location, except as noted otherwise, shall consist of the following:
 - 1. 2 each single gang 2,4 or 6 port faceplate. Faceplates must have label fields top & bottom.
 - 2. The faceplate for the data communication cable shall be the same color and height co-ordinate with the electrical faceplate. Only one color faceplate shall be used throughout the project. Only flush mount type jacks are to be used on this project (unless otherwise noted on the drawings).
- B. 2 each Category 5 modular jack with an RJ45 connection, with wire caps to provide strain relief and contamination protection, and also to accommodate colored icons.

Section 3.04 2.03 BACKBOARDS

- A. Backboards shall be 18mm thick plywood, coated with fire-retardant paint. Confer with the Local Authority's specification to ascertain size, placement, etc. Size shall be adequate to support all specified/required devices as minimum.
- B. The backboards shall be painted with fire-retardant paint and color coded to Local Authority's requirement.

Section 3.05 2.04 PATCH CORDS

- A. CATEGORY 6 – Eight position modular plug to eight position modular plug: Patch cords shall be pre-assembled and factory tested, with Category 6 cable & eight position snagless modular plugs.

Section 3.06

Section 3.07 3.01 STATION JACK INSTALLATION – FLUSH MOUNT

- A. All cable installation and termination shall adhere to the provisions in TIA/EIA 568 and TIA/EIA TSB40-A.
 - 1. The Contractor is required to submit a sample of assembled cable, connectors, raceway and accompanying specification sheets prior to installation for approval of quality, workmanship and materials.
 - 2. The length of each station cable shall not exceed 90 meters. Station cable is defined as that length of cable from the back of the workstation outlet to the back of the Patch Panel or connecting block in the telecommunications closet. Station cable shall be a continuous run of cable with no splices, bridges, or other discontinuities.
 - 3. Maintain cable twist-rate at all termination points. The amount of cable untwist shall be no more than 15mm. Do not strip back the cable jacket any more than is necessary to punch down the individual conductors.
 - 4. All 110 connections shall be installed using a single 110 punch down tool and all terminations shall be trimmed flush with connector blocks.
 - 5. Leave enough cable (2 meter at each outlet and 5 meters at the backboard, rack, or hub locations) to allow proper cable connections.
 - 6. Station cable that runs outside the walls shall be in surface-mounted raceway, cable tray, or conduit.
 - 7. Minimum 20mm conduit shall be installed in all walls and shall be run to above ceiling line. Terminate all conduits with plastic bushings. A minimum 200 ts polyline pull string shall be provided the entire length of each conduit.
 - 8. When conduit runs from room to room, provide a metered tape and a minimum 200 ts polyline pull string to run the entire length of the conduit.
 - 9. Conduit bends must be long, sweeping bends with radius not less than: 6 times the internal diameter of conduits 50mm or smaller; or, 10 times the internal diameter of conduits larger than 50mm.
 - 10. Each cable installation shall be accompanied by a minimum 200 ts polyline pull string.
 - 11. Cables shall not be tie wrapped to electrical or gas conduit. Maintain a minimum 100mm separation between low voltage cabling and electrical raceways, lights, etc.
 - 12. D-rings will be provided and mounted to route the station cables at the backboard locations (& in chase locations as designated on the drawings).
 - 13. Enough cable slack will be provided to neatly route the station cable through the "ID" rings to the appropriate 110 type block.
 - 14. No communications or data circuit shall be run in the same conduit or raceway with power conductor except where the raceway is separated by a divider.

15. Cable routing shall follow the routes dictated by the detail while avoiding locations of high RFI/EMI radiation or adverse environmental conditions.
16. All plastic type molding must be anchored to the wall with the appropriate type of wall screw every 1.5 meters.
17. The Voice/Data cable plant shall be grounded and bonded in accordance with ANSI/TIA/EIA-607.
18. All cable coming from ceiling shall be placed in cable trunks..

Section 3.08

Section 3.09 3.02 WIRING TESTING

- A. Contractor shall provide all necessary testing equipment to test all cables.
 1. Each cable terminating in a station jack shall be tested from the telecommunications closet with a 4-pair wire tester. The tester shall verify continuity, faults, reversals, swaps and pairing.
 2. Each Category 5 cable link shall also be tested for near-end and far-end crosstalk and attenuation up to and including 100 Mhz and shall be verified for acceptable length.
 3. A hard copy of the test results for each cable run shall be provided to the Employer. Acceptable test results shall be agreed upon by the Employer and contractor prior to testing. It is the contractor's responsibility to replace or repair any cables, connectors or jacks which test outside the agreed-upon ranges.
- B. Before the system is approved by the Engineer, the Contractor will be required to "walk-through" the installation with the Employer and verify proper installation and conformance to specifications, drawings, and other agreed upon, written details.
- C. All cable-related documentation and As-Built Drawings will also be required for reviewing purposes at this time.

SECTION – E - 9

CABLE TRAY, LADDER AND TRUNKING

1.0 RELATED DOCUMENTS

Drawings and general provisions of the Contract, including General and Supplementary Conditions and Division 1 Specification Sections, apply to this Section.

2.0 SUBMITTALS

General: Submit the following according to the Division 1 Specification Sections.

Product data for each component. Show tray types, dimensions, and finishes.

Determine the sizes of the cable trays based on the number and size of cables laid on the cable trays plus 20% space for future growth. Cables laid on cable trays shall be spaced twice their overall diameter (consider the largest cable as reference). In case of discrepancy with the contract documents this clause shall prevail, unless approved by the Engineer otherwise.

Shop drawings detailing fabrication and installation of cable tray, including plans, elevations, sections, details of components, and attachments to other construction elements. Designate components and accessories, including clamps, brackets, hanger rods, splice plate's connectors, expansion joint assemblies, straight lengths, and fittings.

Co-ordination drawings, including floor plans and sections drawn to accurate scale. Show accurately scaled cable tray layout and relationships between components and adjacent structural and mechanical elements.

3.0 QUALITY ASSURANCE

Manufacturer Qualifications: Select a firm experienced in manufacturing cable trays which has a record of successful in-service performance.

Comply with the relevant standards of BS, NEMA and NEC.

Single-Source Responsibility: All cable tray components shall be the product of a single manufacturer.

4.0 SEQUENCING AND SCHEDULING

Co-ordination: Co-ordinate layout and installation of cable tray with other installations.

Revise locations and elevations from those indicated as required to suit field conditions and as approved by the Engineer.

5.0 CABLE TRAYS

The cable tray system shall be of one manufacturer and shall include factory made trays, tray fittings, connections and necessary accessories and supports to form a complete tray support system.

The cable tray system shall include the following factory-made tray elements. Straight trays and ladders, fittings and horizontal and vertical bends of various angle crosses, tees, wyes, reducers, vertical riser elements, connectors and all necessary fixing accessories.

Cable trays shall be constructed from mild steel of minimum thickness 16 gauge (1.5 mm). Trays in excess of 300 mm width shall be of minimum thickness 14 gauge (2.0mm).

Insert elements, bolts, screws, pins etc., shall be mild steel cadmium plated.

- a. Tray work shall have oval perforations. Ladder type trays shall be used as required and/or approved by the Engineer.
- b. All trays (straight and fittings) to be heavy duty returned flanged type unless specified otherwise.
- c. Tray component are to be accurately rolled or formed to close tolerance and all edges rounded. Flanges are to have full round smooth edges.

- d. Ladder racks of widths up to and including 300mm shall be constructed from rolled steel sections of minimum thickness 16 gauge (1.5 mm). Ladders in excess of 300 mm width shall be C Section construction with a minimum thickness of 14 gauges (2.0mm). The rungs shall be spaced at a maximum 300 mm.
- e. Unless indicated otherwise on drawings, cable trays shall be used in the range 150 mm to 900 mm wide, in fire preferred standard sizes: 150, 300, 450, 600 and 900 mm.
- f. Other sizes shall be used where specified or previously agreed with the Engineer.
- g. Flanges shall be a minimum of 50 mm deep.
- h. Minimum radius at side rails, horizontal and vertical tees and crosses shall be in accordance with the Manufacturer's standard.

Perforated, heavy duty, return flange type, in 2.5m nominal lengths Hot dip galvanized after completion of bending and drilling, complete with all necessary purpose made bends, tees, supports and the like. Width shall be such as to permit adequate access for installation and maintenance of cables and per the requirements of KESC regulations.

6.0 CABLE TRUNKING

Where required, wiring shall be run in hot-dipped galvanized (after fabrication) sheet steel cable trunking of the specified gauge complete with all fittings and accessories, manufactured and installed in accordance with BS 4678/NEMA. The trunking shall be constructed with return flanges. Trunking covers shall be secured by anchored turn-buttons and locking bars and minimum length of individual sections shall be 2.44-m. The trunking shall be suspended/supported from the structure at maximum 2-m intervals with straps and hangers fabricated from minimum 6-mm dia HDGF bars or supported by angle-iron brackets.

Conduit drips from the trunking shall also be supported with hangers. Factory made connectors shall be used at joints.

Junctions (tee and 4-way) in multi-compartment trunking shall be double depth to avoid reduction in cabling space. Cable in vertical runs shall be supported by pin racks, prongs or bridging pieces. Fire barriers shall be provided at each floor level. Allowance for expansion shall be incorporated.

Bonding links shall be provided at each joint and secured by screws, nuts and shockproof washers. The bonding links shall make contact with the metal of the trunking of fitting, and continuity shall not depend on contact through the screws, nor on removal on site paint finish from ferrous metal.

7.0 EXAMINATION

Examine surfaces to receive cable tray, cable trunking and cable ladder for compliance with installation tolerances and other required conditions. Do not proceed with installation until unsatisfactory conditions have been corrected.

8.0 WIRING METHODS

Use cable tray of complete with manufacturer's recommended covers, barrier strips, dropouts, fittings, conduit adapters, hold-down devices, grommets, and blind ends.

9.0 INSTALLATION

- a. Install cable tray, cable trunking and cable ladder level and plumb according to manufacturer's written instructions, rough-in drawings, the original design, and referenced standards.
- b. Remove burrs and sharp edges of cable trays.
- c. Make changes in direction and elevation using standard fittings.

- d. Make cable tray connections using standard fittings.
- e. Locate cable tray above piping except as required for tray accessibility and as otherwise indicated.
- f. Fire stop penetrations through fire and smoke barriers, including walls, partitions, floors, and ceilings, after cables are installed.
- g. Working Space: Install cable trays with enough space to permit access for installing cables.

10.0 GROUNDING

Connect cable trays, cable trunking and cable ladder to ground as instructed by manufacturer. Tighten connectors and terminals, including screws and bolts, according to equipment manufacturer's published torque-tightening values for equipment connectors.

11.0 CLEANING

Upon completion of installation of system, including fittings, inspect exposed finish. Remove burrs, dirt, and construction debris and repair damaged finishes, including chips, scratches, and abrasions.

SECTION - E – 10
IP BASED CLOSED CIRCUIT TELEVISION (CCTV) SYSTEM

1.0 GENERAL

- A. All equipment and materials used shall be standard components that are regularly manufactured and used in the manufacturer's system.
- B. All systems and components shall have been thoroughly tested and proven in actual use.
- C. All systems and components shall be provided with the availability of a toll-free, 24-hour technical assistance program (TAP) from the manufacturer. The TAP shall allow for immediate technical assistance for either the dealer/installer or the end user at no charge for as long as the product is installed.
- D. All systems and components shall be provided with a one-day turnaround repair express and 24-hour parts replacement. The repair and parts express shall be guaranteed by the manufacturer on warranty and non-warranty items.

2.0 GENERAL SPECIFICATIONS

IP MEGAPIXEL CAMERA (INDOORWALL TYPE):

The camera shall be compact rugged, IR, 1.3Mega pixel 1/3 image sensor format digital color having the horizontal resolution of 1280x720 TVL or above with outstanding picture quality. The camera shall provide easy installation, digital signal processing, on screen displays, superior picture quality reliability. The camera shall accept AC or DC POE type. The camera shall provide auto-detection of lens type with lens wizard. The camera shall provide night sense feature to extend the excellent sensitivity in low light conditions.

The camera shall provide automatic sensing for tracking white balance. The camera shall support bidirectional communication technology using standard video cable. The camera shall be line locked to the power line zero crossing to ensure roll free vertical interval video switching and recording.

The rated voltage shall be 12VDC, 24 VAC 50 Hz and POE option. The operating temperature shall be -20 to 50 degree Celsius. Humidity shall be 5 to 93% non-condensing. Shock resistance shall be minimum 50 gm.

Signal to Noise Ratio	:	50 dB
Electronic shutter	:	AES or 1/77000 sec.
White Balance	:	Automatic sensing, (2500 – 9000K)
Video output	:	Composite video 1.0 Vp-p, 75 ohms.
Aperture correction	:	Horizontal and vertical, symmetrical.
BLC	:	Center window weighting
Synchronization	:	Line Lock (When powered by AC only) Synchronizes the camera to the power line zero crossing for roll-free vertical interval switching. (When DC supply) Internal crystal.
Video Compression	:	H. 264, multicast streaming.

Networking	:	10/100/1000 Mbps gigabit Ethernet, RJ-45
Viewing Requirement	:	ONVIF
Field Of View	:	31 to 87, 25 to 880, 35 to 105 (Horizontal, Vertical & Diagonal)
Image Resolution	:	Main stream 1280 x 720 @ 25/30 fps. Feature: Extra stream shall be provided.
Audio Compression	:	Built-in
Support Protocol	:	TCP/IP, UDP, SMTP, UPNP, FTP, HTTP or etc.
Data Storage	:	Video or Snapshot. Built-in (Micro SD).
Low light Capabilities	:	0.0013 Lux. Additional feature should be removable IR cut filter mechanism for increased sensitivity.
Lens	:	DC Iris.
Security	:	Password protection, IP address filtering, user access log.
Users	:	10 Simultaneous users.
Video Analytic	:	Adaptive motion analytic to intelligently detect motion within the field of vision and trigger an alarm. Also detects vehicles near sensitive areas longer than the users define time. Also count the objects that enter in a define zone. Also any object placed in a define zone and then trigger alarm. Cameras shall have maximum feature which shall meet clients requirements.
Imaging Device	:	16:9 Aspect Ratio 1/3 inch, effect 4:3 Aspect ratio 1280 x 720 @ 1.3 MP x1.
Cabling type	:	Cat-6
Alarm Pan Input	:	22 to 34 VAC 24 VAC nominal or POE.
Alarm I/P	:	10 VDC max, 75 mA max
Alarm O/P	:	0 to 15 VDC max, 75 mA.
Service Port	:	External 3 Connection 2.5 m pwds.
Certification	:	FCC, CE, UL/UL Listed.

3.0 INDOOR TYPE IP CAMERA (DOME TYPE):

The camera shall be compact rugged, 1.3 Mega pixel 1/3 (3 to 12mm) varifocal lens & image sensor format digital color having the horizontal resolution of 1280x720 TVL or above with outstanding picture quality. The camera shall provide easy installation, digital signal processing, on screen displays, superior picture quality reliability. The camera shall accept AC or DC POE type. The camera shall provide auto-detection of lens type with lens wizard. The camera shall provide night sense feature to extend the excellent sensitivity by a factor 3 in low light conditions.

The camera shall provide automatic sensing for tracking white balance. The camera shall support bidirectional communication technology using standard video cable. The camera shall be line locked to the power line zero crossing to ensure roll free vertical interval video switching and recording.

The rated voltage shall be 12VDC, 24 VAC 50 Hz and POE option. The operating temperature shall be -20 to 50 degree Celsius. Humidity shall be 5 to 93% non-condensing. Shock resistance shall be minimum 50 gm.

Signal to Noise Ratio	:	50 dB
Electronic shutter	:	Automatic, 1/5 to 1 /132,000 sec. CCIR, 1/60 to 1/150000 sec. (EIA)
White Balance	:	Automatic sensing, (2500 – 9000K)
Video output	:	Composite video 1.0 Vp-p, 75 ohms.
Aperture correction	:	Horizontal and vertical, symmetrical.
BLC	:	Center window weighting
Synchronization	:	Line Lock (When powered by AC only) Synchronizes the camera to the power line zero crossing for roll-free vertical interval switching. (When DC supply) Internal crystal.
Video Compression	:	H. 264, multicast streaming.
Networking	:	10/100/1000 Mbps gigabit Ethernet, RJ-45
Viewing Requirement	:	ONVIF
Field Of View	:	24 to 65, 15 to 37, 28 to 75 (Horizontal, Vertical & Diagonal)
Image Resolution	:	Main stream 1280 x 720 @ 25/30 fps. Feature: Extra stream shall be provided.
Audio Compression	:	Built-in
Support Protocol	:	TCP/IP, UDP, SMTP, UPNP, FTP, HTTP or etc.
Data Storage	:	Video or Snapshot. Built-in (Micro SD).
Low light Capabilities	:	0.0013 Lux. Additional feature should be removable IR cut filter mechanism for increased sensitivity.
Lens	:	DC Iris.
Security	:	Password protection, IP address filtering, user access log.
Users	:	10 Simultaneous users.
Video Analytic	:	Adaptive motion analytic to intelligently detect motion within the field of vision and trigger an alarm. Also detects vehicles near sensitive areas longer than the users define time. Also count the objects that enter in a define zone. Also any object placed in a define zone and then trigger alarm. Cameras shall have maximum feature which shall meet clients requirements.
Imaging Device	:	16:9 Aspect Ratio 1/3 inch, effect 4:3 Aspect ratio 1280 x 720 @ 1.3 MP x1.
Cabling type	:	Cat-6
Pan I/P	:	22 to 34 VAC 24 VAC nominal or POE.
Alarm I/P	:	10 VDC max, 75 mA max
Alarm O/P	:	0 to 15 VDC max, 75 mA.
Service Port	:	External 3 Connection 2.5 m pwds.
Certification	:	FCC, CE, UL/UL Listed.

4.0 OUTDOOR TYPE IP SPEED CAMERA:

The camera shall be compact weather proof, IP Speed Dome 36 x optical zoom format digital color having the horizontal resolution of 12 x DIGITAL ZOOM (530) TVL or above with outstanding picture quality. The camera shall provide easy installation, digital signal processing, on screen displays, superior picture quality reliability. The camera shall accept AC or DC POE type. The camera shall provide auto-detection of lens type with lens wizard. The camera shall provide night sense feature to extend the excellent sensitivity by a factor 3 in low light conditions.

The camera shall provide automatic sensing for tracking white balance. The camera shall support bidirectional communication technology using Cat-6. The Cameras shall high speed pan up to 260°/sec and tilt up to 120°/sec. built-in web browsing.

The rated voltage shall be 12VDC, 24 VAC 50 Hz and POE option. The operating temperature shall be -20 to 50 degree Celsius. Humidity shall be 5 to 93% non-condensing. Shock resistance shall be minimum 50 gm.

Image Sensor	:	¼" CCD
Signal to Noise Ratio	:	50 dB
Electronic shutter	:	Automatic, 1/5 to 1 /132,000 sec. CCIR, 1/60 to 1/150000 sec. (EIA)
White Balance	:	Automatic sensing, (2500 – 9000K)
Video output	:	Composite video 1.0 Vp-p, 75 ohms.
Aperture correction	:	Horizontal and vertical, symmetrical.
BLC	:	Center window weighting
Synchronization	:	Line Lock (When powered by AC only) Synchronizes the camera to the power line zero crossing for roll- free vertical interval switching. (When DC supply) Internal crystal.
Video Compression	:	H. 264, multicast streaming.
Networking	:	10/100/1000 Mbps gigabit Ethernet, RJ-45
Viewing Requirement	:	ONVIF
Field Of View	:	24 to 65, 15 to 37, 28 to 75 (Horizontal, Vertical & Diagonal)
Resolution	:	530 TVL
Sensor Element	:	PAL 752 (H) x 582 (V)
Lens Type	:	36 x optical zoom, 12 x digital zoom.
Focal Length	:	F1.6 ≈r 3.8 f=3.4≈122.4mm.
Illumination	:	1.4 lux /0.01 lux.
Pan Range	:	On 360° Continuous, Speed 0.5 or 260°/sec.
Preset Point/ Tour	:	32 Preset, 16 Camera tour.
Focus	:	Auto/manual.
Video Capture	:	H.264,4CIF/CIF/QCIF
MJPEG	:	4CIF/CIF/QCIF
Image Frame rate	:	30 fps (N), 25 fps (P) for all resolution.
2 way audio	:	Simplex/Duplex 2 way audio.
Lan port	:	RJ45 Connector, 10/100 M auto.
Alarm/out	:	Dry contact or relay output standard.
RS 485	:	For external keyboard.

Audio In/Out : Microphone in/out.
Video Out : 1.0 Vp-p/75Ω Bnc optional.

116
Motion Detection : 1.5 Zone.
OS : Windows based.
Security : Password protection.
Certification : FCC, CE, UL

5.0 MANUFACTURER'S WARRANTY

Repair or replacement of defective parts for a period of two years from the date of shipment, installation.

6.0 IP Video Management Systems (VMS):

- A. IP VMS shall support minimum 100 channel and the direct analog cameras.
- B. IP VMS shall provide 6 to 10 Mbps for recording of analog and IP video stream, play back and export.
- C. IP VMS shall support recording of H.264, JPEG, and MPEG-4 IP Stream.
- D. IP VMS shall support third party H.264 Megapixel video stream up to 10Mps resolution with total system throughout recording of all IP & analog streams, playback and export.
- E. The IP VMS shall have fully open architecture with support for both IP Specific Cameras and as well as ONVIF Compliance.
- F. The VMS shall support H.264 compression, CIF 4CIF resolution at maximum 100 FPS, 16audio input and RS422/485 PT2 Control with supplied system/ third party compatible protocol.
- G. VMS shall support unlimited no's of system connected over network. Each system shall contain 5 16GB min network ports, one for IP Camera/Encoder data, 1 for client computer access.
- H. VMS shall view, managed, & playback through single user interface simultaneously with other compatible VMS through supplied PC Server & PC Client Software.

7.0 HARDWARE:

- A. The VMS server shall operate on 2nd generation Intel® Core i7 processor and 8 GB of Ram or approved equivalent.
- B. VMS server shall utilize windows 7" ultimate 64 bit operating system or windows based equivalent operating system. But it should not lesser than windows 7 ultimate.
- C. VMS server shall have internal DVD +RW
- D. VMS server shall have two DV1-D ports.
- E. VMS server shall have expansions of IP video channel capacity through a licensing without any modification in hardware.
- F. VMS server shall support multiple make/models of IP Camera and encoders including third party manufacturer.
- G. VMS server shall also support audio recording in addition to third party manufacturer's audio recording.
- H. VMS server shall support recording the internal storage (Built-in)server with additional storage utilize SCSI attached HDD1 storage.

- I. VMS server shall capable of continuous scheduled alarm/event and motion recording, pre and post alarm recording also be available and full programmable on per channel basis.
- J. The VMS system shall allow archival of video data to computers or SAN storage devices over a network connection with optional compatible archive utility. The archival schedule shall be either automatic at user defined intervals or manual and shall be configurable per connected per connected camera.
- K. VMS shall indicate system performance.
- L. RAIDS or NAS storage media built in an external shall be used. Minimum 16 TB built in shall be required. Manufacture should submit the data storage calculation prior to bidding.
- M. System shall have 6, 3.5 inch drive and optical DVR ± RW.
- N. System shall have PC1-E slots x 16 and PC1-E x 4.
- O. Auxiliary interfaces shall be USB 2.0 and USB 3.0 ports.
- P. 100 to 240 VAC 50/60 Hz, Auto ranging.
- Q. The maximum frame per second for recording or storage shall be 15 fps. Supplier shall be responsible for better resolution and good result.
- R. The resolution or frame size is not less than 1280 x 720.
- S. System should have recording capacity for 90 days recording of all cameras at 24 hours a day.

8.0 CLIENT SOFTWARE

- A. The IP VMS shall be capable running client application.
- B. The minimum client hardware configuration shall be Intel core I7 with required graphic cards.
- C. The memory shall be 4 GB or high.
- D. The system shall have optical drive like DVR +.
- E. The optical system shall be windows based XP professional or as engineer approved.
- F. The system shall have required accessories like connecting cables, programming, hardware for rack mounting recovery disc etc.
- G. The client software shall include all licenses for any additional third party cameras. No additional license cost shall be barred by client.
- H. The client software shall have capable for interface the multiple DVR or NVR platforms.
- I. The client system & software shall support minimum 20 to 25 cameras matrix on required fps resolution. It is the suppliers' responsibility to provide the better resolution and performance.
- J. The client system & software shall provide live video review and record video view with at least 1, 5, 15, 30, 60 or 90 minutes.
- K. The client system & software shall capable to selectable in-video PT2 control or dashboard style control.
- L. The system & software shall capable for video export to any accessible media like HDD, DVD or network storage.
- M. The system shall have alarm pop-up featured and playback active alarm. It shall have on motion detection.
- N. The system & software shall have capable for matrix functionality whereby cameras sequences creating on monitor.

ELECTRICAL:

Input Voltage 100-240 VAC, 50Hz, auto ranging

Note:

The active switches (POE type) is the responsibility of Client IT personal. Passive equipment such as CAT 6 cables and patch panels has been covered in telecom BOQ. Submittal must be submit to consultant / client for review and approval.

SECTION - E – 11 EARTHING SYSTEM

1.0 SCOPE OF WORK

The work under this scope consists of supplying, installation and commissioning of all material and services of the complete earthing system as specified herein and / or shown on the Tender Drawings and given in the Bill of Quantities.

The Contractor shall discuss the electrical layout with the Engineer and coordinate at site with other services for exact route, location and positions of the electrical lines and equipment.

The Earthing system with accessories shall also comply with the General Specifications for Electrical Works, Section E- I and with other relevant provisions of the Tender document.

2.0 GENERAL

The earthing system consists of earth electrodes, earthing leads, earth connecting points, earth continuity conductors and all accessories necessary for the satisfactory operation of the associated electrical system.

3.0 STANDARDS

The latest editions of the following standards / codes shall be applicable for the materials covered within the scope of this specification:

BS 951	Earthing Clamps
BS 1433	Hard drawn bare copper conductor for earthing.
BS 2874	Nuts, Bolts, Washers and Rivets for use on copper.
BS 6346	PVC Insulated Cables.
CP 1013	Earthing

Any other standard referred to in above standards or these specifications.

4.0 MATERIAL

4.1 Earth Rod Electrodes

Drive extensible rods of the same diameter into the ground, either manually or by power driven hammer, to a suitable depth to obtain low resistivity in the particular soil.

Weld earth connectors to the top of the rods, in sufficient number to take all incoming cables.

4.2 Earthing Lead

The earthing lead shall connect the earth electrode to earth connecting point or equipment in the building. It shall be round hard drawn bare electrolytic copper of size shown on the drawings. The cost of earthing leads deemed to have been included in the price of earth electrode & no separate pavement shall be made for it.

4.3 Earth Continuity Conductor

Earth continuity conductor (E.C.C) shall be hard drawn bare copper wire or single core PVC insulated copper conductor cable of sizes indicated on the drawings. All thimbles, lugs, sockets, nuts, washers and other accessories necessary for the complete installation of ECC shall be provided by the Contractor without any extra cost.

The specifications for single core PVC insulated cables used as E.C.C. shall be same as those given in section E - 3 of these specifications. PVC insulated cables when used as E.C.C. shall be green,

5.0 INSTALLATION

Complete earthing systems as shown on the drawing shall be installed by the Contractor. The earthing system shall give earth resistance, including resistance of soil, earth leads and E.C.C. equal to less than one ohm, this without ground pits water spraying.

The earthing system shall be loop connected with earthing cables at least 300 mm away from telephone cables. The concept of the main loops and the way they are connected shall be such that equipment / apparatus can be easily removed without requiring a complex disconnection operation nor risking interruption of / or damage to the loop itself. The fastening of the earthing conductors shall be made on a sufficient length so as to prevent crushing or cross section weakening. The parts on which they are connected shall be conveniently cleansed and surface.

Leads sheaths or steel tape armours are not permitted as grounding conductors. The earthing system shall be installed to ensure that when any part of the earthing system is disconnected for the purpose of carrying out periodic testing an alternative path to earth is available.

At all connections of earth continuity conductor to LV Switchboard, LV Distribution Board or any other metallic body, proper size or brass sockets, thimbles or lugs shall be used to which the copper wire shall be connected by copper brazing. The soldering of copper wire at joints or termination shall not be allowed. All tee-off connections shall be by copper brazing using suitable socket and clamps. After brazing, the jointed surface shall be protected by oxide inhibiting compound of low electrical resistance. For connections to metallic body, the surface shall be thoroughly cleaned before bolting the lug or socket.

The earth continuity conductor shall be in general run in cable trench or in conduits / pipes as shown on the drawings. For under floor runs, these shall be installed in pipe / conduit of appropriate sizes. Where laid along under ground cables, these shall be laid directly under ground in unpaved areas and in pipes under paved areas.

The electrode plate shall be installed at a minimum depth of 5 meters from finished ground level or 1 meter below permanent water level, whichever is less. The minimum horizontal distance between earth electrodes shall be 3 meters. Proper mixture of lime and charcoal in the ratio of 1:3 shall be made and buried along with the copper plate in the ground to increase the soil conductivity. The electrode shall be installed as per details shown on the drawings. The inspection chambers shall be constructed at locations approved by the Engineer.

A 50 mm diameter G.I. shall be provided from inspection chamber to earth plate for watering purposes. The pipe shall have 10 mm diameter holes at 500 mm center to center all along the length. At the ground level an inspection chamber with cast iron cover shall be constructed having dimensions as shown on the drawings. The inspection chamber shall have a copper supported on angle iron frame. The cover shall be hinged type, as approved by the Engineer and shall finish flush with the ground level.

The earth connecting point shall be installed at locations shown on the drawings. It shall be fixed on wall surface by means of brass screws with nuts, washers and other insulating material as instructed by the Engineer.

The earth continuity conductor of sizes shown on the drawing shall be installed all along the cable runs and connected to the earthing bar / terminals provided in the equipment. The body of all Switchboards shall be connected to earth by specified size of E.C.C. All metal work shall also be connected to earth by specified size of E.C.C.

At any joint or termination, the E.C.C. shall be connected using proper accessories. No connection shall be made by twisting of earth conductors.

SECTION – 8

LIST OF SPECIFIED MATERIAL

LIAQUAT UNIVERSITY OF MEDICAL & HEALTH SCIENCES,
JAMSHORO, SINDH.

CONSTRUCTION OF HOSTEL FOR MALE POST GRADUATE STUDENTS

LIST OF SPECIFIED MATERIAL.

S.NO	MATERIAL	BRAND NAME	MANUFACTURER	AGENCY / DISTRIBUTOR	SOURCE
1	ORDINARY PORTALAND / SULPHATE RESISTANCE CEMENT	LUCKY BRAND/D.G KHAN/ FALCON			HYDERABAD
2	WHITE CEMENT	MAPLE LEAF OR ANWARZEB			HYDERABAD
3	CRUSHED STONE				ONGAR/ NORIABAD
4	SAND				BOLHARI/ NORIABAD
5	STEEL (DEFORMED)	AMRELLI/ RAZZAK/ FF STEEL/NAVEEN A			HYDERABAD SINDH
6	FIRST CLASS BURNT BRICKS				
7	GLAZED TILES		MASTER / SHABBIR TILES OR APPROVED EQUIVALENT		HYDERABAD
8	PORCELAIN TILES		SHABBIR / MASTER / GRANITE/SONE X OR EQUIVALENT APPROVED		HYDERABAD
9	ALUMINIUM DOORS / WINDOWS		LUCKY / PAK CABLE		MANUFACTURER SUPPLY

LIST OF APPROVED ELECTRICAL & ELV MANUFACTURER

Samples of all equipment's shall have to be got approved prior to their procurement. The bidder has to sign and stamp all pages of Annexure-1. Any deviation from the BoQ / Specification shall be listed in a separate sheet to be labeled as Annexure-2 containing the details of the deviation including the deviating BoQ item number.

S.No	Manufacturer / Supplier	Country Of Origin
LOW VOLTAGE (LV) PRODUCTS		
LV Switchboards / Distribution Boards / PFI Panels		
a.	Baber Brothers	Pakistan
b.	Volamp	Pakistan
c.	Al-Rehman Switchgear	Pakistan
d.	PEL	Pakistan
Circuit Breakers		
a.	M.G. (Schneider Electric)	France / Italy
b.	Terasaki	Japan / Malaysia / Spain
c.	ABB	Germany / Italy
d.	Siemens	Germany
CT, PTs Relay & Instruments		
a.	Schneider Electric.	France
b.	Siemens	Germany
c.	Revalco	Italy
d.	ABB	Italy
PFI Plant		
a.	Nokian	Finland
b.	Schneider	France
c.	ABB	Italy
d.	Circuitor	France
Load Break Switches, Changeover Switches		
a.	Socomec	France
b.	Kraus & Naimer	Austria
Push Buttons, Switches, Etc.		
a.	Schneider Electric	France / Italy
b.	Maruyasa	Japan/Malaysia/Indonesia
LV Cables & Wires		
a.	Pakistan Cables	Pakistan
b.	Fast Cables	Pakistan
c.	Allied Cables	Pakistan

S.No.	Manufacturer / Supplier	Country Of Origin
Cable Glands, Lugs, Terminals and Accessories		
a.	Cembre	UK
b.	Hubbell / Hawke	UK
PVC Conduits and Accessories		
a.	Galco	Pakistan
b.	Dadex	Pakistan
c.	Jeddah Polymer	Pakistan
d.	Civic	Pakistan
Cable Tray / Trunking		
a.	A to Zee	Pakistan
b.	Premier Engineering	Pakistan
c.	Ashraf Industries	Pakistan
Back Boxes		
a.	Hussain & Co.	Pakistan
b.	Hensel	Germany
c.	Jeddah Polymer	Pakistan
Switch & Socket Outlets / Floor Boxes		
a.	Clipsal (Schneider Electric)	Australia / Singapore
b.	M.K.	UK
c.	Legrand	France/UK
FAN & Accessories		
a.	Pak Fan	Pakistan
b.	GFC Fan	Pakistan
c.	Millat Fan	Pakistan
Lighting Fixtures		
a.	Philips	Netherland/China
b.	nVc	USA/China
c.	Pierlite	Australia/China
d.	Sunlight	China
Contactors		
a.	Telemecanique (Schneider Electric)	France / Italy
b.	National	Japan
c.	ABB	Germany
Earthing		
a.	Furse	UK
b.	Wallis	UK

LOW CURRENT PRODUCTS		
S.No.	Manufacturer / Supplier	Country Of Origin
Telephone Cable		
a.	Clipsal (Schneider Electric)	Australia / France
b.	3M	UK
c.	Panduit	UK
CCTV		
a.	DAHUA	China
b.	HIKVISION	China
c.	ACTI	Korea

SECTION – 9

BILL OF QUANTITIES

YOUNG ASSOCIATES(CONSULTING ENGINEERS AND ARCHITECTS)

LIAQUAT UNIVERSITY OF HEALTH SCIENCES JAMSHOR

CONSTRUCTION OF HOSTEL BUILDING

SUMMARY OF COST

1 **CIVIL WORKS**

a). Schedule Rate items. Rs. _____

b). Non-Schedule Rate items. Rs. _____

TOTAL (a+b) Rs. _____

2 **PLUMBING / MECHANICAL WORKS**

b). Non-Schedule Rate items. Rs. _____

TOTAL (a+b) Rs. _____

3 **ELECTRICAL WORKS**

a). Schedule Rate items. Rs. _____

b). Non-Schedule Rate items. Rs. _____

TOTAL (a+b) Rs. _____

TOTAL COST (1+2+3)	Rs.	-
---------------------------	------------	----------

CONTRACTOR

YOUNG ASSOCIATES(CONSULTING ENGINEERS AND ARCHITECTS)

NAME OF WORKS:

CONSTRUCTION OF HOSTEL BUILDING

CLIENTS:

LIAQUAT UNIVERSITY OF HEALTH SCIENCES

JOBS DESCRIPTION:

BILL OF QUANTITY FOR CIVIL WORKS

SINDH PWD SCHEDULE OF RATES

SIXTH EDITION - 2012 PUBLICATION NO.52

Item No.	Description	Quantity	Rate (Rs.)	Unit	Amount (Rs.)
	<u>A - SCHEDULE ITEM</u>				
1	<u>EXCAVATION</u> Excavation in foundation of Building, Bridges and other structures including dagbeling dressing, refilling around structure with excavated earth, watering and ramming lead upto 5 ft.				
1a	ordinary soil Item 18-b page # 04	14,019	3,176.25	%0 Cft	44,528
1b	hard rock Excavation in hard rock requiring blasting but blasting prohibited and disposal of excavated material upto 50 ft.Lead (including dressing and levelling to designed section etc, complete Item 7-b page # 02	35,238	25,936.00	%0 cft	913,930
2	<u>EARTH FILL</u> Filling, watering and ramming earth under floor with new earth (Excavated from out side) lead upto one chain and lift upto 5 feet. Item 22 Page- 4	82,397	3,630.00	%o Cft	299,102
3	<u>LEAN 1:4:8</u> Cement concrete plain including placing compacting, finishing and curing, complete (including screening and washing of stone aggregate without shuttering) Ratio 1:4:8 Item 5 (i) Page 16	16,348	11,288.75	% Cft	1,845,454
4	<u>PCC 1:3:6</u> Cement concrete plain including placing compacting, finishing and curing, complete (including screening and washing of stone aggregate without shuttering) Ratio 1:3:6 Item 5 (h) Page 16	3,555	12,595.00	% Cft	447,717
5	Erection of removal of centering for RCC or plain cement concrete works of Partal wood.				
b (ii)	vertical item 19 b(ii) page 18	22,709	3,127.41	% Sft	710,211
6	<u>DPC</u> Damp Proof course with (cement sand and shingle				
b	1:2:4) including 2 coats of asphaltic mixture 2" th. Item 28 Page 19	1,957	3,912.85	% Sft	76,566

Item No.	Description	Quantity	Rate (Rs.)	Unit	Amount (Rs.)
7	<u>CC 1:2:4</u> Providing and laying 1" thick topping cement concrete (1:2:4) including surface finishing and dividing into panels:				
c	2" TH FLOORING	32,710	3,275.50	% Sft	1,071,416
d	3" TH SCREEDING item 16 d page 42	19,797	4,411.82	% Sft	873,408
8	<u>PACCA BRICK WORK</u> Pacca brick work G.F (i) Ground Floor Ratio 1:4 Item 5(i) (c) Page-21	36,383	13,227.41	% Cft	4,812,505
9	<u>PLASTER(1/2")</u> Cement plaster 1:4 - 1/2" thick. Item 11 (b) Page-52	149,857	2,283.93	% Sft	3,422,632
10	<u>PLASTER(3/4")</u> Cement plaster 1:4 - 3/4" thick. Item 11 (c) Page-52	149,857	3,015.76	% Sft	4,519,331
11	<u>G.I DOOR FRAMES</u> Providing and fixing G.I. frames / chowkhats of size 7" x 2" or 4-1/2" x 3" for doors using 20 guage G.I. sheet i/c welded hinges and fixing at site with necessary hold fasts, filling with cement sand slurry of ratio 1:6 and repairing the jambs. The cost also i/c all carriage, tools and plants used in making and fixing. Item No. 29 Page 93	2,046	228.90	P.Rft	468,387
12	<u>PLASTIC EMULSION PAINT</u> (a). Preparing surface and painting with plastic emulsion paint of approved make i/c rubbing the surface with rubbing brick / sand Paper, filling the voids with chalk / plaster of Paris and then painting etc complete. (ICI Brand) Item 40-A Page 56 Each subsequent coat of paint (2 coats) 2 X 578.60 = 1157.2	117,939	1,080.75	% Sft	1,274,629
	(b). 2nd and Subsequent coat Item 40 - B Page 56	117,939	1,157.20	% Sft	1,364,793

Item No.	Description	Quantity	Rate (Rs.)	Unit	Amount (Rs.)
13	<u>WEATHER SHIELD PAINT</u> (a). Preparing surface and painting with weather coat i/c rubbing the surface with rubbing brick / sand Paper, filling the voids with chalk / plaster of Paris and then painting with weather coat of approved make (ICI Brand). Item 38-A Page 56 Each subsequent coat of paint (2 coats) 2 X 619.85 = 1239.70	29,530	1,328.25	% Sft	392,230
	(b). 2nd and Subsequent coat Item 38 - B Page 56	29,530	1,239.70	% Sft	366,081
14	<u>DISTEMPER</u> Distemping c)three coats item no. 24 - c page no. 54	43,645	1,079.65	% Sft	471,213
15	<u>WATER PROOFING UPTO GROUND LEVEL</u> <u>(BITUMEN COATING)</u> Bitumen coating to plastered or cement concrete surfaces. item no. 9 page no. 71	15,906	778.09	% Sft	123,763
		TOTAL COST			23,497,896
		Add _____ % Above			
		Amount carried to summary			

Item No.	Description	Quantity	Rate (Rs.)	Unit	Amount (Rs.)
	<u>B - NON-SCHEDULE ITEM</u>				
1	<u>ANTI-TERMITE</u> Provide and apply Antitermite Treatment using Mirage of Ali Akber Enterprises or equivalent approved in various stages eg. under gorund treatment,under footings and also including all wood works.Plinth area will be measured once for all operations.(Contractor to provide 10 years guarantee for entire work)	33,000		Sft	
2	<u>REINFORCED CEMENT CONCRETE</u> Providing and laying reinforced cement concrete using Hub River crushed stone aggregate 3/4 inch (19 mm) and down gauge having a minimum works cylindrical crushing strength of 3000 psi for foundation, plinth beam, roof beam, slab, wall and columns at 28 days of any shape including water tight form work and its removal, compacting, leveling viberating and curing etc. complete but excluding the cost of reinforcement. Sulphate resisting cement will be used up to Plinth level as follows:				
1	Footing	8,100		CFT	
2	Plinth beam	6,873		CFT	
3	Columns	6,567		CFT	
4	Roof beams	19,141		CFT	
5	Slabs	19,846		CFT	
6	stairs	500		CFT	
7	OHWT	1,698		CFT	
8	Waffle slab	4,204		CFT	
3	<u>REINFORCEMENT STEEL</u> Providing and laying hard grade ribbed deformed (minimum yield point 60,000 psi) reinforcement bars of all sizes with & including the cost of straightening, cutting, bending, binding, wastage, overlaps other than those shown on drawings, steel chairs, placing in position on cement concrete precast chairs, tying with binding wire, cost of chairs and binding wires etc. included in all kinds of RCC works. complete	124,759		Kg	

Item No.	Description	Quantity	Rate (Rs.)	Unit	Amount (Rs.)
4 A	<p><u>ALUMINIUM SOLID DOOR / WINDOWS DOORS</u> FOR MAIN ENTRANCE Providing, fabricating and fixing solid aluminium doors of 1.2mm thick champagne colour aluminum frame main entrance doors with aluminium sheet of approved make and design made with Deluxe section along with champagne colour aluminum frame FIXED GLASS fixing in C.C. etc. at any height or any floor, including all fittings, fixtures as specified and directed by the Engineer in charge (Pakistan Cable)</p>	175		Sft	
B	<p><u>WINDOWS</u> Provide and install in position Champaign color Aluminum windows, (deluxe model) double swing (Pakistan Cable/ prime brand make) consisting of all hardware, hinges, handle, locks, 5mm thick tinted / plain glass etc complete as per drawing, Specification & instruction of engineer.</p>	4,167		Sft	
4	<p><u>SOLID WOOD DOOR SHUTTERS</u> Provide and fix in position Deodar wood door 1-1/2" thick solid core shutter 3 mm ply on both sides fixed over best quality frame, architraves, 3 mm aluminium sheet 24" wide, Latch CGI / Alpha, hold fast, tower bolt, Door stopper, imported mortice locks of approved quality, Paint / polish complete in all respect as per drawing and as directed (Toilet doors)</p>	4,365		Sft	
5	<p><u>MORTICE LOCK</u> Providing and fixing approved quality mortice lock.</p>	184		No.s	

Item No.	Description	Quantity	Rate (Rs.)	Unit	Amount (Rs.)
6	<u>TILE WORKS</u>				
a	Providing and laying vitrified tiles 16"x16" pak made Master / Stile or approved equivalent brand on floor or wall facing in required colour and pattern of specification joint filled with white cement and matching colour pigment over a base of 2 inch thick cement concrete 1:2:4 base for floor 1:2 grey cement mortar 3/4" thick for wall in Dado including washing and filling of joints with slurry of white cement and pigment in desired shade with finishing cleaning etc complete in any floor as per direction of Engineers.(for toilet)	7,260		Sft	
b	Providing and laying 16" x16" vitrified tiles of STILE or equivalent approved brand on floor in approved colour and pattern as per specification in white cement and pigment over base and of 2 inch cement base including washing and filling of joints with slurry of white cement and pigment in desired shade with finishing cleaning etc complete	50,498		Sft	
c	Providing and laying 4 inch high skirting of STILE tiles approved shade in cement mortar 1:2 over 1/2 inch thick cement mortar 1:4 base including finishing tile joints with white cement mixed with pigment of matching colour filling joints etc complete in all floor.	5,925		Rft	
7	<u>MARBLE</u>				
	Providing and Fixing 3/4 inch thick marble on tread with chemical polished and with cement mortar with matching pigment grout in joints polishing etc complete.	1,845		Sft	
	Providing and Fixing 3/8" inch thick tiles of 12"x6" size in risers with cement mortar with matching pigment grout in joints polishing etc complete.	240		Sft	
8	<u>ACRYLIC BASED TEXTURE PAINT</u>				
	Provide and apply one coats of ACRYLIC BASED TEXTURE PAINT (BERGER/ICI or equivalent) to walls with rubbing, scrapping, filling, primer coat, including wastage, etc. complete as per instructions of the engineer.	1,500		SFT	

Item No.	Description	Quantity	Rate (Rs.)	Unit	Amount (Rs.)
9	<u>STAIR RAILING</u> Providing and laying M.S Steel Railling 3'-0 high on one side of seating stair steps, 1/2 inch square bar fixed at 4 inch centre to centre encased in 3/4" powder coated pipe of approve design including, 1-1/2 x 3/16 inch M.S flat, embeded in R.C.C step, including the cost of 3" x 4" shesham wood polished Hand rail, Straight or curved, painting enamel paint I.C.I over redoxide etc complete.	2,129		Rft	
10	<u>DRIP COURSE</u> Making drip course 1" x 1/2" on chajjas or openings in plaster surface with true edges, uniform depth and base smoothly finished etc. complete as per the instruction of Engineer Incharge.	1,014		Rft	
11	<u>WATER SPOUT</u> providing and fixing UPVC 4" dia and 42" water spout at slab to drainage water fixing with cement mortar surround should be water proof.Complete in all respects.	40		No.s	
12	<u>WATER PROOFING</u> Providing and applying two coats of crystalline, penetrative capillary waterproofing (MasterSeal 501, BASF) or equivalent approved brand on RCC walls complete as per the instructions of Engineer Incharge.	1,700		SFT	
			TOTAL "B"		
	Total "A"& "B" carried to summary				

BILL OF QUANTITY

SUMMARY OF COST

S. NO.	DESCRIPTION	TOTAL AMOUNT IN PAK RUPEES
B	NON SCHEUDLE ITEMS FANS FIRE EXTINGUISHERS PLUMBING	
	TOTAL OF NON SCHEDULE ITEMS (Rs.) =====>>	
	GRAND TOTAL MECHANICAL WORKS AMOUNT (A+B) (Rs.) =====>>	

BILL OF QUANTITY

S.NO.	DESCRIPTION	QTY	UNIT	RATE (Rs.)	AMOUNT (Rs.)
	PART - B (NON SCHEDULE ITEMS)				
1	FANS				
a)	Supply Installation & Commissioning of Industrial Exhaust and Ventilation fans along with MS frame with Riverted joints Wall Mounted with Backdraft Dampers, as per manufaturer recommendation and schedule				
i	EF-01	7	Nos		
ii	EF-02	2	Nos		
iii	EF-03	1	Nos		
iv	EF-04	1	Nos		
v	EF-05	1	Nos		
vi	EF-06	1	Nos		
vii	EF-07	1	Nos		
2	FIRE EXTINGUISHERS				
a)	Providing and fixing of Portable Wall Mounted Fire Extinguisher, FM & UL approved as per NFPA recommendation				
i	ABC Type	2	Nos		
ii	CO2 Type	2	Nos		
CARRIED TO MECHANICAL SUMMARY =====>>>					

BILL OF QUANTITY

S.NO.	DESCRIPTION	QTY	UNIT	RATE (Rs.)	AMOUNT (Rs.)
2	PLUMBING				
1	PPRC pipe conforming to DIN 8077-8078 (PN-20) for Cold & Hot water systems, with all fittings and specialities, including all cutting, fitting, fixing and cleaning, wall and slab sleeves, CP clamps, hangers and supports, making connections, with fixtures, valves and specials, chiseling, making wall and floor openings and making good, pressure testing at a test pressure of 100 psig, painting of exposed pipes in occupied areas with primer and coats of approved paint in approved colour, complete in all respects. Jointing Mothod: Heat Fusion				
a)	1/2" dia	1850	Rft		
b)	3/4" dia	750	Rft		
c)	1" dia	1250	Rft		
c)	1-1/2" dia	650	Rft		
d)	2" dia	450	Rft		
2	UPVC Pipe conforming to ISO 3633 (SDR-26) including all fittings, sockets, hangers and specials for soil and waste stacks and horizontal runs buried in ground or above false ceiling, in shafts exposed or concealed in floors and walls and connecting to manholes, including cutting, fitting, chiseling, making good, fixing and cleaning, wall and slab openings complete in all respect.				
	4" dia	1850	Rft		
3	UPVC pipe conforming to BS: 3505 class B including all fittings, sockets, buried in soil for sewerage system, connection with manholes including cutting, fitting, chiseling fixing,making good, fixing and cleaning complete in all respect. Jointing Mothod				
	6" dia	750	Rft		
CARRIED TO MECHANICAL SUMMARY =====>>>					

BILL OF QUANTITY

S.NO.	DESCRIPTION	QTY	UNIT	RATE (Rs.)	AMOUNT (Rs.)
S.NO.	DESCRIPTION	QTY	UNIT	RATE (Rs.)	AMOUNT (Rs.)
4	Providing and Fixing squatting white glazed earthen ware W.C. pan with front flush inlet and complete with including cost of flushing cistern with internal fitting and flush pipe with bend and making requisite number of holes in walls plinth & floor for pipe connections and making good in cement concrete	8	Qty		
5	Providing and Fixing European white glazed Earthen ware wash down W.C. pan complete with and including the cost of white plastic seat (best quality) and lid with C.P. brass hinges and buffers, 3 gallons white earthen glazed earthen ware low level flushing cistern with siphon fitting 1-1/2" dia white porcelain enamelled flush bend 3/4" dia and making requisite number of holes in walls, plinth and floor for pipe connections and making good in cement concrete	14	Qty		
5	Providing and fixing lavatory basin as per Architectural specs white glazed earthen ware complete with and including cost of W.I. or C.I. cantilever brackets 6 inches built into walls, painted white in two coats after primary coat of red lead paint a pair of 1/2" dia rubber plug and chrome painted brass chain 1-1/4" dia dia, malleable iron or brass unions and making requisite number of holes in walls, plinth and floor for pipe connections and making good in cement concrete	20	Qty		
6	Providing and fixing in position Nyloon connections complete with 1/2" dia, brass stop cock with pair of Brass nuts and lining joints to Nyloon connections	8	Qty		
7	Add extra labor for providing and fixing of earthen ware pedestal white	20	Qty		
8	Providing & constructing block masonry manhole size (3' x 3' internal) with Cast Iron cover & frame including 1/2" thick plaster and benching complete in all respect.	12	Qty		
9	Providing & constructing Gully Trap complete in all respect.	5	Qty		
10	Floor drains for toilets and kitchen etc. as per specification complete in all respects. 4" dia	54	Qty		
CARRIED TO MECHANICAL SUMMARY =====>>>					

BILL OF QUANTITY

S.NO.	DESCRIPTION	QTY	UNIT	RATE (Rs.)	AMOUNT (Rs.)
S.NO.	DESCRIPTION	QTY	UNIT	RATE (Rs.)	AMOUNT (Rs.)
11	Bronze Gate valves, and Check valves, Kitz make or approved equal including all accessories and material as specified complete as per drawings and specifications. Gate Valves 1/2" dia 3/4" dia 1" dia Other valves and fittings not mentioned are to taken in sundries	36 16 8 1	Qty Qty Qty Lot		
12	Clean outs including jointing and testing complete in all respect (UPVC). 4" dia	22	Qty		
13	Kitchen Sink Stainless Steel double bowl with dual drain board including all accessories such as sink mixer, PVC flexible pipe, waste pipe coupling ect. Complete including bottle trape all joints to service and drains plugging and screwing as necessary to the stucture.	1	Qty		
14	Providing and fixing of Water Transfer pump including foundation, control panel wiring from panel to pumps, valves, piping, accessories etc from Suction to discharge as indicated in schedule TP-01 Flow = 110 gpm Head = 200 ft	1	Qty		
15	Providing and Fixing Chrome platted Muslim shower and Bib Cocks, locally manufactured best quality	26	Qty		
16	Providing and Fixing Under ground and Over head Tanks, complete with excavation, backfilling, valve and accessories complete in all respect as mentioned in drawing	1	Job		
17	Providing and Fixing Septic Tanks, complete with excavation, backfilling, valve and accessories complete in all respect as mentioned in drawing	1	Job		
18	Providing and Fixing Hot Water Geyser 48 Gallon Gas Geyser, locally manufactured, with all accessories	8	Nos		
CARRIED TO MECHANICAL SUMMARY =====>>>>					

BILL OF QUANTITY

SUMMARY OF COST

S. NO.	DESCRIPTION	TOTAL AMOUNT IN PAK RUPEES
A	SCHEDULE ITEMS	
1	SUB HEAD I MAINS & SUB-MAINS	2,496,607
2	SUB HEAD XI ELECTRICAL ACCESSORIES	428,992
	TOTAL OF SCHEDULE ITEMS (Rs.) =====>>>	2,925,599
	ADD PREMIUM ON SCHEDULE ITEMS ABOVE/BELOW _____%	
	TOTAL OF SCHEDULE ITEMS WITH PREMIUM (Rs.) =====>>>	
B	NON SCHEDULE ITEMS	
1	LOW VOLTAGE CABLES AND WIRES	
2	L.V. DISTRIBUTION BOARDS	
3	CONDUITS & PIPES	
4	WIRING ACCESSORIES	
5	LIGHT FIXTURES & FANS	
6	VOICE & DATA COMMUNICATION SYSTEM	
7	CCTV SYSTEM	
8	CABLE TELEVISION SYSTEM (CATV)	
9	EARTHING SYSTEM	
	TOTAL OF NON SCHEDULE ITEMS (Rs.) =====>>>	
	GRAND TOTAL ELECTRICAL WORKS AMOUNT (A+B) (Rs.) =====>>>	

BILL OF QUANTITY

S.NO.	Gov. of Sindh CSR-2012 Schedule item # /Page #	DESCRIPTION	QTY	UNIT	RATE (Rs.)	AMOUNT (Rs.)		
1	D	<u>PART - A (SCHEDULE ITEMS)</u>						
		<u>SUB HEAD I MAINS & SUB-MAINS</u>						
		<u>WITH 3 WIRE PVC CONDUIT RECESSED IN THE WALL OR COLUMN</u>						
		1.1	Item # 22(D)/ P-3/ Second Edition-2012	Providing & laying (MAIN or SUB MAIN) PVC insulated with size 3-3/.029 copper conductor in ¾" dia PVC conduit recessed in the wall or column as required.	4,125	Per Mtr.	220.00	907,500
		1.2	Item # 24(D)/ P-4/ Second Edition-2012	Providing & laying (MAIN or SUB MAIN) PVC insulated with size 3-7/.029 copper conductor in ¾" dia PVC conduit recessed in the wall or column as required.	1,610	Per Mtr.	294.00	473,340
		1.3	Item # 25(D)/ P-4/ Second Edition-2012	Providing & laying (MAIN or SUB MAIN) PVC insulated with size 3-7/.036 copper conductor in ¾" dia PVC conduit recessed in the wall or column as required.	2,880	Per Mtr.	338.00	973,440
		1.4	Item # 26(D)/ P-4/ Second Edition-2012	Providing & laying (MAIN or SUB MAIN) PVC insulated with size 3-7/.044 (6mm ²) copper conductor in 1" dia PVC conduit recessed in the wall or column as required.	45	Per Mtr.	468.00	21,060
		1.5	Item # 101(P)/ P-12/ Second Edition-2012	<u>N</u> <u>WITH 4 CORE OVERHEAD OR UNDERGROUND</u> <u>300/500</u>				
				Providing & laying (MAIN or SUB MAIN) PVC insulated & PVC sheeted with 4 core copper conductor 300/500 volts size 10mm ²	32	Per Mtr.	742.00	23,744
		1.6	Item # 102(P)/ P-12/ Second Edition-2012	<u>O</u> <u>WITH 4 CORE OVERHEAD OR UNDERGROUND</u> <u>600/1000</u>				
				Providing & laying (MAIN or SUB MAIN) PVC insulated & PVC sheeted with 4 core copper conductor 600/1000 volts size 16mm ²	6	Per Mtr.	1,300.00	7,800
		1.7	Item # 103(P)/ P-12/ Second Edition-2012	Providing & laying (MAIN or SUB MAIN) PVC insulated & PVC sheeted with 4 core copper conductor 600/1000 volts size 25mm ²	47	Per Mtr.	1,909.00	89,723
				Note: Contractor is advised to confirm the running length before commencement of work.				
		CARRIED TO ELECTRICAL SUMMARY =====>>>						2,496,607

BILL OF QUANTITY

S.NO.	Gov. of Sindh CSR-2012	DESCRIPTION	QTY	UNIT	RATE (Rs.)	AMOUNT (Rs.)
	Schedule item # /Page #					
2	B	SUB HEAD XI ELECTRICAL ACCESSORIES CEILING ROSE				
2.1	Item # 228(B)/ P-33/ Second Edition-2012	Providing & fixing Bakelite ceiling rose with two terminals.	130	Per No.	72.00	9,360
2.2	C Item # 235(C)/ P-34/ Second Edition-2012	FAN Providing & fixing Brass Ceiling fan 56'' (good quality)	130	Per No.	3,185.00	414,050
2.3	Item # 236(C)/ P-34/ Second Edition-2012	Providing & fixing Brass Bracket fan 18'' (good quality)	2	Per No.	2,791.00	5,582
CARRIED TO ELECTRICAL SUMMARY =====>>>						428,992

BILL OF QUANTITY

S.NO.	DESCRIPTION	QTY	UNIT	RATE (Rs.)	AMOUNT (Rs.)
	<u>PART - B (NON SCHEDULE ITEMS)</u>				
1	LOW VOLTAGE CABLES AND WIRES Supply, laying, termination, tagging, testing and commissioning of following size copper conductor multi core / single core, Cu/PVC, Cu/PVC/PVC, unarmoured, 0.6 kV/1 kV, 450/750V or 300/500V voltage grade copper cable in already laid conduit / cable tray / trench including all accessories lugs, cable gland etc. as per drawings and specifications, complete in all respect. Note: Contractor is advised to confirm the actual running length before commencement of work. Note: Contractor is advised to confirm the actual running length before commencement of work.				
a)	1 Core - Cu/PVC Cable				
i	4 x 1 Core - 6 Sq.mm Cu/PVC	200	Rm.		
b)	1 Core - Cu/PVC Cable as ECC				
i	1 Core - 16 Sq.mm Cu/PVC	47	Rm.		
ii	1 Core - 10 Sq.mm Cu/PVC	38	Rm.		
iii	1 Core - 6 Sq.mm Cu/PVC	200	Rm.		
CARRIED TO ELECTRICAL SUMMARY =====>>>					

BILL OF QUANTITY

S.NO.	DESCRIPTION	QTY	UNIT	RATE (Rs.)	AMOUNT (Rs.)
2	L.V. DISTRIBUTION BOARDS				
a)	Supply, installation, testing and commissioning of following wall mounting / floor standing surface type Main Distribution Board (MDB), Sub Main Distribution Boards (SMDB's) and Distribution Board (DB's) made with 16 SWG sheet metal, dust protected, vermin proof housing coated with approved color having all the necessary switching, energy analyzer etc., protections, as per drawing and specification, complete in all respect.				
i	MDB-HOSTEL with 15 kVAR PFI	1	No.		
ii	SMDB-GF(HOSTEL)	1	No.		
iii	DBLP-GF01	1	No.		
iv	DBLP-GF02	1	No.		
v	DBLP-FF01	1	No.		
vi	DBLP-FF02	1	No.		
vii	DBLP-GF-COM	1	No.		
b)	Supply, installation, testing and commissioning of following Isolators in 16 SWG sheet steel enclosure with neutral and earth terminal strips, including all mounting accessories as per specifications and drawings, complete in all respect.				
i	32A, TPN Weatherproof type Isolator	3	No.		
CARRIED TO ELECTRICAL SUMMARY =====>>>>					

BILL OF QUANTITY

S.NO.	DESCRIPTION	QTY	UNIT	RATE (Rs.)	AMOUNT (Rs.)
3	CONDUITS & PIPES				
a)	Supply and laying of following size (inner dia) PVC Conduit / uPVC Pipe, as race ways with all accessories, recessed / surface on wall / column / roof / under floor etc., as per specifications and drawings, complete in all respect.				
i	25 mm dia PVC Conduit	25	Rm.		
ii	32 mm dia PVC Conduit	25	Rm.		
iii	38 mm dia PVC Conduit	155	Rm.		
iv	50mm dia uPVC Pipe (Class-D)	85	Rm.		
b)	Supply and installation of Pull Boxes (Floor / Wall) 16 SWG, Size 8" x 8" with all installation accessories, as per drawings, specifications and approved brands, complete in all respect.	5	No.		
c)	Providing and Construction of Handhole Size 2'-0" x 2'-0" x 3' 0" deep, 6"thick, concrete 1:2:4 ratio with 2' round heavy duty cast iron cover, 100% water proof, as per specification as shown on the drawing, as per drawings and specification etc., complete in all respect.	3	No.		
CARRIED TO ELECTRICAL SUMMARY =====>>>					

BILL OF QUANTITY

S.NO.	DESCRIPTION	QTY	UNIT	RATE (Rs.)	AMOUNT (Rs.)
4	WIRING ACCESSORIES				
a)	Supply, installation, testing and commissioning of following 10/13/15/20A, gang type switches, Dimmer Switches, Sockets including 16 SWG Sheet Steel powder coated back boxes with earth terminal, including with all required installation accessories, surface / recessed in wall / column etc., as per specifications and drawings, complete in all respect.				
i	One Gang Switch 10A	8	No.		
ii	Two Gang Switch 10A	124	No.		
iii	Three Gang Switch 10A	6	No.		
iv	Four Gang Switch 10A	8	No.		
v	One Gang Fan Dimmer with Switch 10A	130	No.		
vi	13A, International Switch Socket Outlet	175	No.		
vii	13A, 3-Pin Flat 2-Gang Switch Socket Outlet	106	No.		
viii	13A, Unswitched Spur Outlet	38	No.		
ix	15A, 3-Pin Switch Socket Outlet	4	No.		
x	20A, Double Pole Switch with neon indicator	2	No.		
xi	32A, 5-Pin Industrial Socket with Plug top	2	No.		
CARRIED TO ELECTRICAL SUMMARY =====>>>					

BILL OF QUANTITY

S.NO.	DESCRIPTION	QTY	UNIT	RATE (Rs.)	AMOUNT (Rs.)
5	LIGHT FIXTURES & FANS				
a)	Supply, installation, testing and commissioning of following light fixtures complete with all installation and mounting accessories etc., as per specification and drawings, complete in all respect. Note: Refer light fixtures drawings for complete light fixtures details.				
i	LIGHT TYPE-A Surface mounted LED Light Fixture (IP-20), UV Shield Poly Carbonate housing, Stainless Steel Bracket and 1x40W LED lamp	214	No.		
ii	LIGHT TYPE-B Surface mounted LED Downlight Fixture (IP-20), Aluminum / Die Cast housing, Glass cover and 1x18W LED lamp	314	No.		
iii	LIGHT TYPE-C Wall mounted LED Wall Bracket Light Fixture (IP-54), UV Shield Poly Carbonate housing, Stainless Steel Bracket and 1x20W LED lamp	13	No.		
iv	LIGHT TYPE-D Suspended mounted LED Pendant Light Fixture (IP-20) with 1x20W LED lamp	18	No.		
v	LIGHT TYPE-Q Surface mounted Emergency Exit Light Fixture (3 Hrs Battery Backup, Maintained Type) (IP-20) with Poly Carbonate housing and 8W LED Lamp	8	No.		
vi	LIGHT TYPE-R Surface mounted Emergency Light Fixture (3 Hrs Battery Backup, Non-Maintained Type) (IP-65) with Poly Carbonate housing and 8W LED Lamp	32	No.		
CARRIED TO ELECTRICAL SUMMARY =====>>>					

BILL OF QUANTITY

S.NO.	DESCRIPTION	QTY	UNIT	RATE (Rs.)	AMOUNT (Rs.)
6	<u>VOICE, DATA COMMUNICATION & CCTV CABLING SYSTEMS</u> <u>(Passive Equipment Only)</u>				
a)	Supply, installation, testing and commissioning of following Data / Voice Cabinets, for patch panel, Fiber panels, adapter, PDU's, Fans and space for active switches as it may require to complete the entire passive and active network as per the single line diagram, drawings and specifications, complete in all respect.				
i	12U Data Rack with PDU's (800mmx800mm)	1	No.		
b)	Supply, installation, testing and commissioning of Dual RJ-45, Cat-6 outlet for Voice & Data with shutter type and 16 SWG back box including tagging, as per drawing and specification, complete in all respect.	7	No.		
c)	Supply, installation, testing and commissioning of Single RJ-45, Cat-6 outlet for Camera with shutter type and 16 SWG back box including tagging, as per drawing and specification, complete in all respect.	14	No.		
d)	Supply, installation, testing and commissioning of Single RJ-45, Cat-6 Data outlet for Wifi with shutter type and 16 SWG back box including tagging, as per drawing and specification, complete in all respect.	24	No.		
e)	Supply, laying, termination, testing and commissioning of CAT 6 - 4 pair cable for Single RJ-45 outlet (Data, Voice, Camera and Wifi system) in 25mm dia PVC conduit concealed / surface from each outlet to IDF racks, including tagging and piping with all necessary accessories, complete in all respect.	2490	Rm.		
f)	Supply, installation, testing and commissioning of 24 port shutter type Cat 6, RJ 45 UTP Patch Panel fully loaded with tool less jacks and rear cable manager, as per drawing and specification, complete in all respect.	3	No.		
g)	Supply, installation, testing and commissioning of 24 port Multi Mode Fiber Patch Panel fully loaded with pigtails etc., and rear cable manager, as per drawing and specification, complete in all respect.	1	No.		
h)	Supply, installation, testing and commissioning of 19" front/rear (as required) cable organizer between patch panels and active equipment to provide patch cable management including with all necessary accessories, as per drawing and specification, complete in all respect.	4	No.		

BILL OF QUANTITY

S.NO.	DESCRIPTION	QTY	UNIT	RATE (Rs.)	AMOUNT (Rs.)
j)	Supply, installation, testing and commissioning of CAT-6 UTP (RJ-45 to RJ-45) for the above Patch Panels including with all necessary accessories, as per drawing and specification, complete in all respect.				
i	CAT-6 (1m) Long Patch Cord	52	No.		
ii	CAT-6 (3m) Long Patch Cord	52	No.		
k)	Supply, installation, testing and commissioning of following 19" Tag blocks in Data rack, as per drawing and specification, complete in all respect.				
i	1x50 Pair IDC Block 19" type	1	No.		
l)	Installation, testing and commissioning by Manufacturer Authorized Agent / Dealer and handing over complete Voice & Data System to Owner with Providing Training voice data fuke & OTDR Testing, as build drawing, Rack layouts and certification's Principal, complete equipment's Manual and Warranty Documents to Owners representative.	1	Job.		
CARRIED TO ELECTRICAL SUMMARY =====>>>>					

BILL OF QUANTITY

S.NO.	DESCRIPTION	QTY	UNIT	RATE (Rs.)	AMOUNT (Rs.)
7	CCTV SYSTEM Supply, installation, testing and commissioning of following items for CCTV System, described below including all accessories, complete with mounting brackets, installation accessories, wiring etc. as per drawings and specifications, complete in all respect.				
a)	Supply, installation, testing and commissioning of 2 MP IP based box camera with 1/2.8" CMOS 3.3 TO 12mm varfocal lens, power adopter, wall mounted bracket, and IP-65 housing, complete in all respect with fixing accessories, as per drawing and specifications, complete in all respect.	14	No.		
b)	Supply, installation, tagging, testing and commissioning of 16 Channel NVR with RAID 1+0 configuration based, built-in VMS built-in HDD for 24/7 recording with integral access slots for HDD suspension bays & client Licenes, as per drawing and specifications, complete in all respect.	1	No.		
c)	Supply, installation, testing and commissioning of 19" LED Screen, including all mounting accessories etc., as per drawing and specifications, complete in all respect.	1	No.		
d)	Supply, installation, testing and commissioning of 27U CCTV Rack (Wall/Floor mounted), equipped with power distribution units (PDUs) with imported power sockets and proper ventilation system including fan etc., as per drawing and specifications, complete in all respect.	1	No.		
e)	Supply, installation, testing and commissioning of Core i7 Work Station Dual VGA Card, Softwares & Licensed windows 10, as per drawing and specifications, complete in all respect.	1	No.		
f)	Supply, installation, testing and commissioning of variable speed desktop keyboard with all fixing accessories, as per drawing and specifications, complete in all respect.	1	No.		
g)	Installation, testing, commissioning, programming by Manufacturer Authorized Agent / Dealer and handing over complete CCTV System to Owner with providing training, SOP, complete equipment's manual and warranty documents to owners representative.	1	Job.		
CARRIED TO ELECTRICAL SUMMARY =====>>>					

BILL OF QUANTITY

S.NO.	DESCRIPTION	QTY	UNIT	RATE (Rs.)	AMOUNT (Rs.)
8	CABLE TELEVISION SYSTEM (CATV)				
a)	Supply, installation, testing and commissioning of TV outlet face plate with 16 SWG back box, complete in all respects.	4	No.		
b)	Supply, laying, termination, tagging, testing and commissioning of RG-06 Co-axial 75 ohms shielded cable in 25mm dia PVC conduit from TVJB box to TV outlet, concealed, surface in wall, column, roof, ceiling, floor etc, including with tagging and piping and all accessories, as per drawing and specification, complete in all respect.	100	Rm.		
c)	Supply, installation, testing and commissioning of TVJB with 1x4 Way Splitter, as per drawing and specification, complete in all respect.	2	No.		
CARRIED TO ELECTRICAL SUMMARY =====>>>>					

BILL OF QUANTITY

S.NO.	DESCRIPTION	QTY	UNIT	RATE (Rs.)	AMOUNT (Rs.)
9	EARTHING SYSTEM Supply, installation, testing and commissioning of following items for complete earthing system including all connecting accessories as per drawings, specifications and as mentioned in General Notes, complete in all respects.				
a)	Supply, installation, testing and commissioning of following items for complete Earthing system, including Bentonite chemical, other all required materials and accessories, boring, labor, tools, transportation etc, as per drawings and specifications, Complete in all respects with detailed test reports. Note: Earth resistance not more than 1 ohm.				
i	Earth pit with Rod type earth electrode, 3/4" dia and 9 Ft. long copper bonded rod.	1	No.		
b)	Supply, laying, termination, tagging, testing and commissioning of following size PVC insulated Cu. Conductor cable as earth continuity conductor (ECC) installed on surface / in appropriate already installed raceway / in already excavated trench / in already laid pipe, including all accessories lugs, cable gland etc. as per drawings and specification, complete in all respect.				
i	1C, 25 Sq.mm Cu/PVC as ECC	15	Rm.		
CARRIED TO ELECTRICAL SUMMARY =====>>>					

SECTION – 10

FORM OF TENDER

FORM OF TENDER

CONSTRUCTION OF HOSTEL FOR MALE POST GRADUATE STUDENTS

AT

LUMHS, JAMSHORO, SINDH

The Project Manager / Project Coordinator
LUMHS, Jamshoro,
Sindh.

Dear Sir,

1. Having examined the instructions to Tenderers, Conditions of Contract, Special Stipulations, Appendices, Specifications, Bill of Quantities and Drawings for the construction, completion and maintenance of the above named works, we, the undersigned Tenderer, offer to construct, complete and maintain the whole of the said works in accordance with the said Conditions of Contract, Special Stipulations, Appendices, Specifications, Bill of Quantities and Drawings for the Tender Price of Pakistan Rupees _____

2. Should a Notice of Award accepting this Tender be issued to us, we undertake;
 - a) To abide by and fulfill all the terms and provisions of the Conditions of Contract contained in the documents mentioned above.
 - b) To commence the works within 07 (Seven) days of receipt of the OWNER's written order to commence, and to complete and deliver all the works comprised in the contract on or before the expiry of 18 (Eighteen) calendar months, after receipt of the said order to commence.
 - c) To sign within 14 (fourteen) days following the issue of the said Notice of Award, an Agreement in the form set out in this Tender with such alterations and additions thereto as you may require to adopt such Agreement to the circumstances of this tender, and for this purpose, to attend or to cause one or more representatives duly authorized by us under appropriate power(s) of attorney to attend you office.

3. We agree that this Tender shall remain valid for a period of 90 (ninety) days from the date set for opening the Tenders and it shall remain binding upon us and may be accepted by you at any time before the expiration of the said period.
4. We further agree to pay all costs towards the execution of the formal agreement including the cost of stamps.
5. We understand that unless and until a formal Agreement is prepared and executed, this Tender together with the Tender Documents and Letter of Award accepting this Tender, shall constitute a binding contract between us.
6. We also understand that you are not bound to accept the lowest or any Tender you may receive.
7. As a guarantee for the performance of the undertakings and obligations of this Tender, we submit herewith Earnest Money of equivalents to 2% of total tender cost of Rs. _____ (Rupees _____) in the form of a Pay Order / Demand Draft No. _____ dated _____ of the _____ Bank Ltd, Branch _____ being a Scheduled Bank, made in your favour and made payable to you, without any reference to us, and valid for 90 (ninety) days from the date established for opening of Tenders.
8. We certify that we clearly understand the terms and conditions of agreement as explained in the Tender Documents.

WITNESSES

1. _____

Name and Address
 Of Tenderer _____

2. _____

Title of Person
 Signing the Tender _____

Seal _____

SECTION – 11

TENDER DRAWING

**LIAQAT UNIVERSITY OF MEDICAL & HEALTH SCIENCES (LUMHS), JAMSHORO
HOSTEL FOR MALE POST GRADUATE STUDENTS**

TENDER DRAWINGS

**ARCHITECTURAL ,STRUCTURAL
ELECTRICALE & PLUMBING DARWINGS**

PREPARED BY:

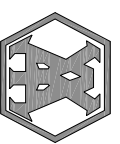

YOUNG ASSOCIATES
CONSULTING ENGINEERS & ARCHITECTS
9-C/24 th Commercial Street, Phase II (Extension) Defence Housing
Authority, Karachi-75500
Tel:021-36396444, 021-36312244, FAX : 021-36883106
E-mail: info @ young associates .com.pk

**LIAQAT UNIVERSITY OF MEDICAL & HEALTH SCIENCES (LUMHS), JAMSHORO
HOSTEL FOR MALE POST GRADUATE STUDENTS**

**TENDER DRAWINGS
ARCHITECTURAL DRAWINGS**

PREPARED BY:

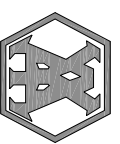

YOUNG ASSOCIATES
CONSULTING ENGINEERS & ARCHITECTS
9-C/24 th Commercial Street, Phase II (Extension) Defence Housing
Authority, Karachi-75500
Tel: 021-36396444, 021-36312244, FAX : 021-36883106
E-mail: info @ young associates .com.pk

LIST OF ARCHITECTURAL DRAWINGS

S.NO.	DWG. NO.	DESCRIPTION
1	322-AR-00	LIST OF DRAWINGS
2	322-AR-101	SITE PLAN
3	322-AR-102	GROUND FLOOR PLAN
4	322-AR-103	FIRST FLOOR PLAN
5	322-AR-104	ROOF FLOOR PLAN
6	322-AR-105	ELEVATION & SECTIONS
7	322-AR-106	STAIR CASE-1 PLAN & SECTIONS
8	322-AR-107	STAIR CASE-2 PLAN & SECTIONS
9	322-AR-108	BOUNDARY WALL

<p>3rd Revision : _____ Date : _____</p> <p>2nd Revision : _____ Date : _____</p> <p>1st Revision : _____ Date : _____</p> <p>ISSUED FOR : _____</p> <p>CLIENT : LIAQUAT UNIVERSITY OF MEDICAL & HEALTH SCIENCES, JAMSHORO, SINDH PAKISTAN</p> <p>JOB TITLE : HOSTEL FOR MALE POST GRADUATE STUDENTS</p>	<p>TENDER DRAWING</p> <p>DATE : 18-11-2021</p> <p>DESCRIPTION : LIST OF DRAWINGS</p> <p>JOB NO. : 322</p> <p>DRG. NO. : 322-AR-00</p> <p>DRAWN BY : AMMR</p> <p>CHECKED BY : HUMA</p> <p>SCALE : 1"=30'-0"</p> <p>DATE : 18-11-2021</p>
--	---

YOUNG ASSOCIATES
CONSULTING ENGINEERS & ARCHITECTS
9-C 24 In Commercial Street, Phase 2 (E-01),
Defence Housing Authority, Karachi-75500
Tel : 021-35398444, 021-35312244
Fax: 021-35383106
Email: info@youngassociates.com.pk

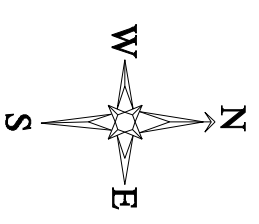

PRINCIPAL BUNGALOW

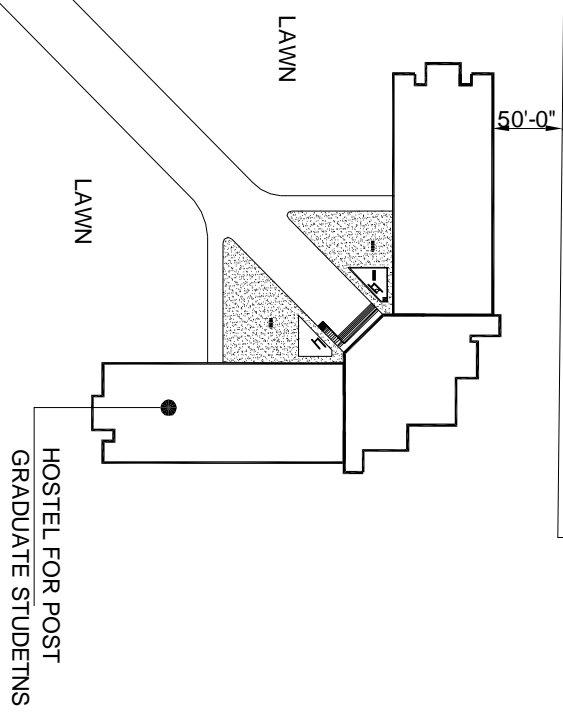
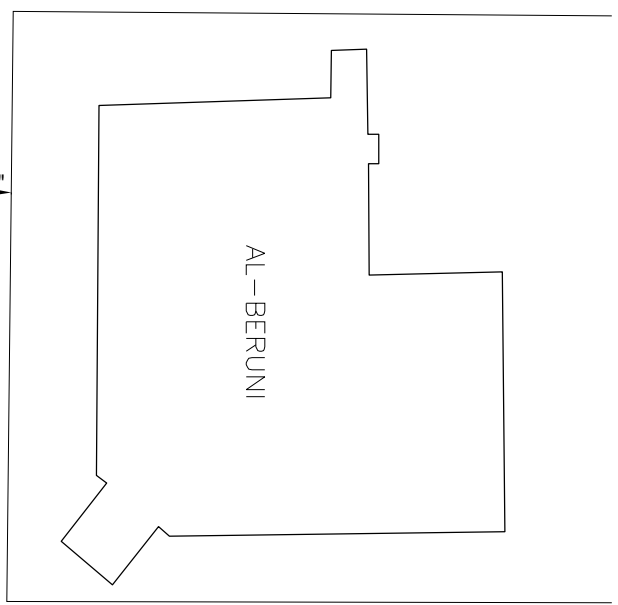
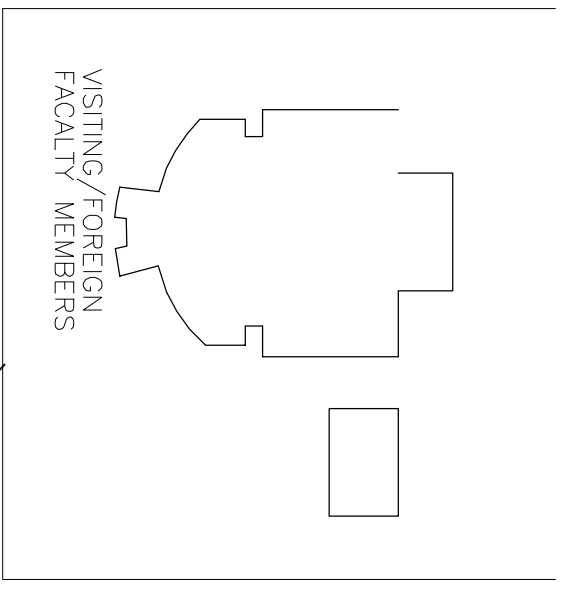

SITE PLAN

3rd Revision :	Date :	*****
2nd Revision :	Date :	*****
1st Revision :	Date :	*****
ISSUED FOR :	TENDER DRAWING	Date : 18-11-2021
CLIENT :	LIAQUAT UNIVERSITY OF MEDICAL & HEALTH SCIENCES, JAMSHORO, SINDH PAKISTAN	
JOB TITLE :	HOSTEL FOR MALE POST GRADUATE STUDENTS	
YOUNG ASSOCIATES	JOB NO. : 322	DESCRIPTION : SITE PLAN
CONSULTING ENGINEERS & ARCHITECTS	DRG. NO. : 322-AR-101	
9-C 24 th Commercial street, Phase 2 (Ekm),	DRAWN BY : AAMIR	CHECKED BY : MUNIER
Defence Housing Authority, Karachi-75500		
Tel : 021-35389144, 021-35312244	SCALE : 1"=300'-0"	DATE : 18-11-2021
Fax : 021-35389144		
Email: info@youngassociates.com.pk		

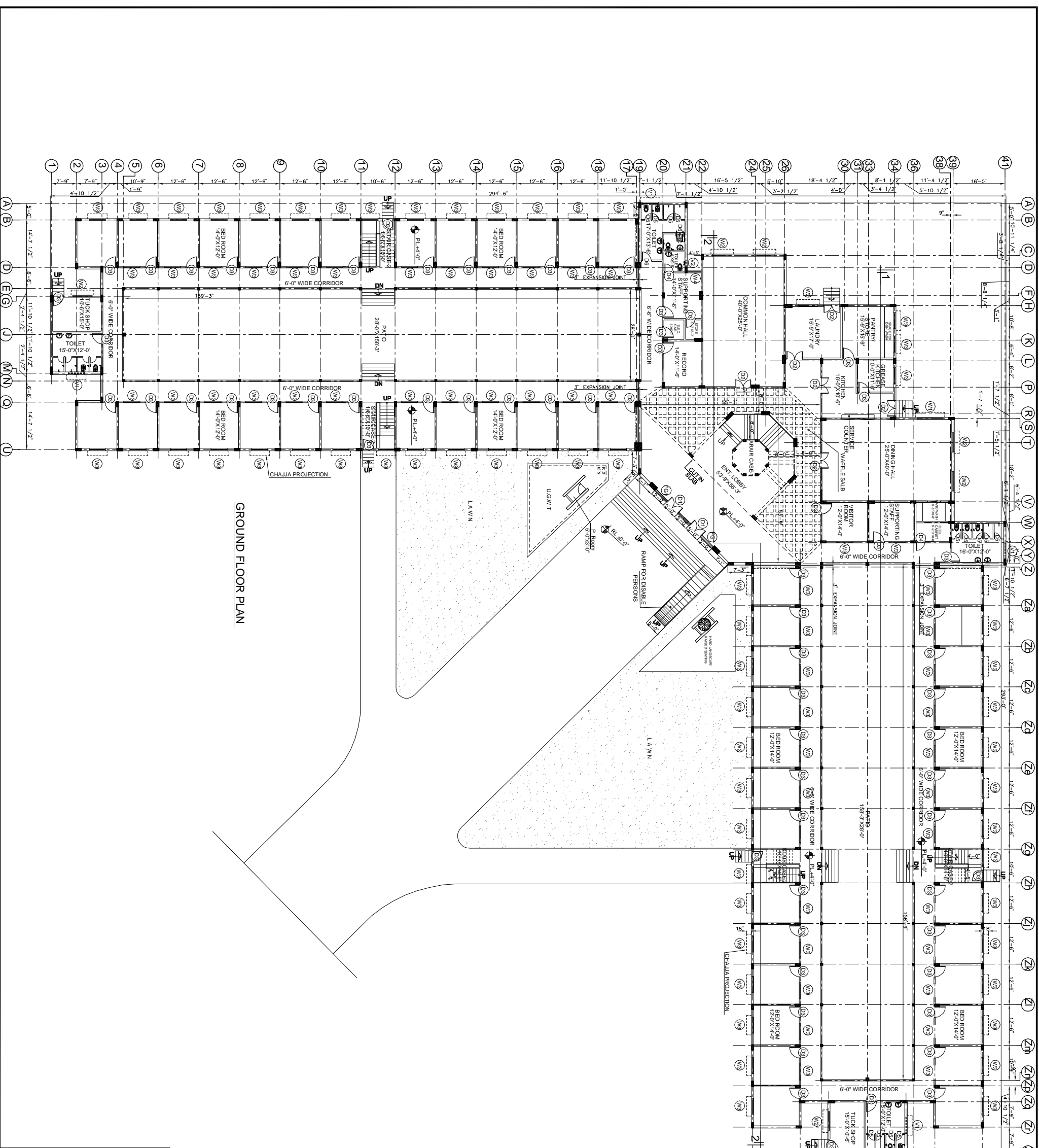

GROUND FLOOR PLAN

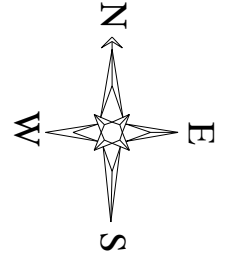

SCHEDULE OF DOORS, WINDOWS & VENTILATORS			DESCRIPTION
S.NO.	DOORS	SIZE	
D-1	5'-0"	7'-0"	ALUMINIUM GLAZED DOOR
D-2	5'-0"	7'-0"	WOODEN FLUSH DOOR
D-3	3'-6"	7'-0"	WOODEN FLUSH DOOR
D-4	2'-9"	7'-0"	WOODEN FLUSH DOOR
D-5	2'-0"	7'-0"	WOODEN FLUSH DOOR
D-6	3'-0"	7'-0"	WOODEN FLUSH DOOR
WINDOWS			
W-1	8'-0"	4'-0"	ALUMINIUM GLAZED WINDOW
W-2	6'-0"	4'-0"	ALUMINIUM GLAZED WINDOW
W-3	4'-0"	4'-0"	ALUMINIUM GLAZED WINDOW
W-4	4'-3"	4'-0"	ALUMINIUM GLAZED WINDOW
FG-1	5'-0"	6'-6"	ALUMINIUM GLAZED
FG-2	25'-0"	4'-0"	ALUMINIUM GLAZED DOOR
VENTILATORS			
V1	5'-0"	2'-0"	ALUMINIUM GLAZED VEN.
V2	2'-0"	2'-0"	ALUMINIUM GLAZED VEN.

3rd Revision : _____ Date : _____
 2nd Revision : _____ Date : _____
 1st Revision : _____ Date : _____
 ISSUED FOR : _____ TENDER DRAWING Date : 18-11-2021

CLIENT : LIAQUAT UNIVERSITY OF MEDICAL & HEALTH SCIENCES, JAMSHORO, SINDH PAKISTAN

JOB TITLE : HOSTEL FOR MALE POST GRADUATE STUDENTS

DESCRIPTION : GROUND FLOOR PLAN

JOB NO. : 322

DRG. NO. : 322-AR-102

SCALE : 1" = 30'-0"

DATE : 18-11-2021

YOUNG ASSOCIATES CONSULTING ENGINEERS & ARCHITECTS
 9-C-24th Commercial Street, Phase 2, I.E.M.I., T-6, J-2021, 3539644, 021-35312244
 E-mail: info@youngassociates.com.pk

DRAWN BY : AMMR
 CHECKED BY : HUMM

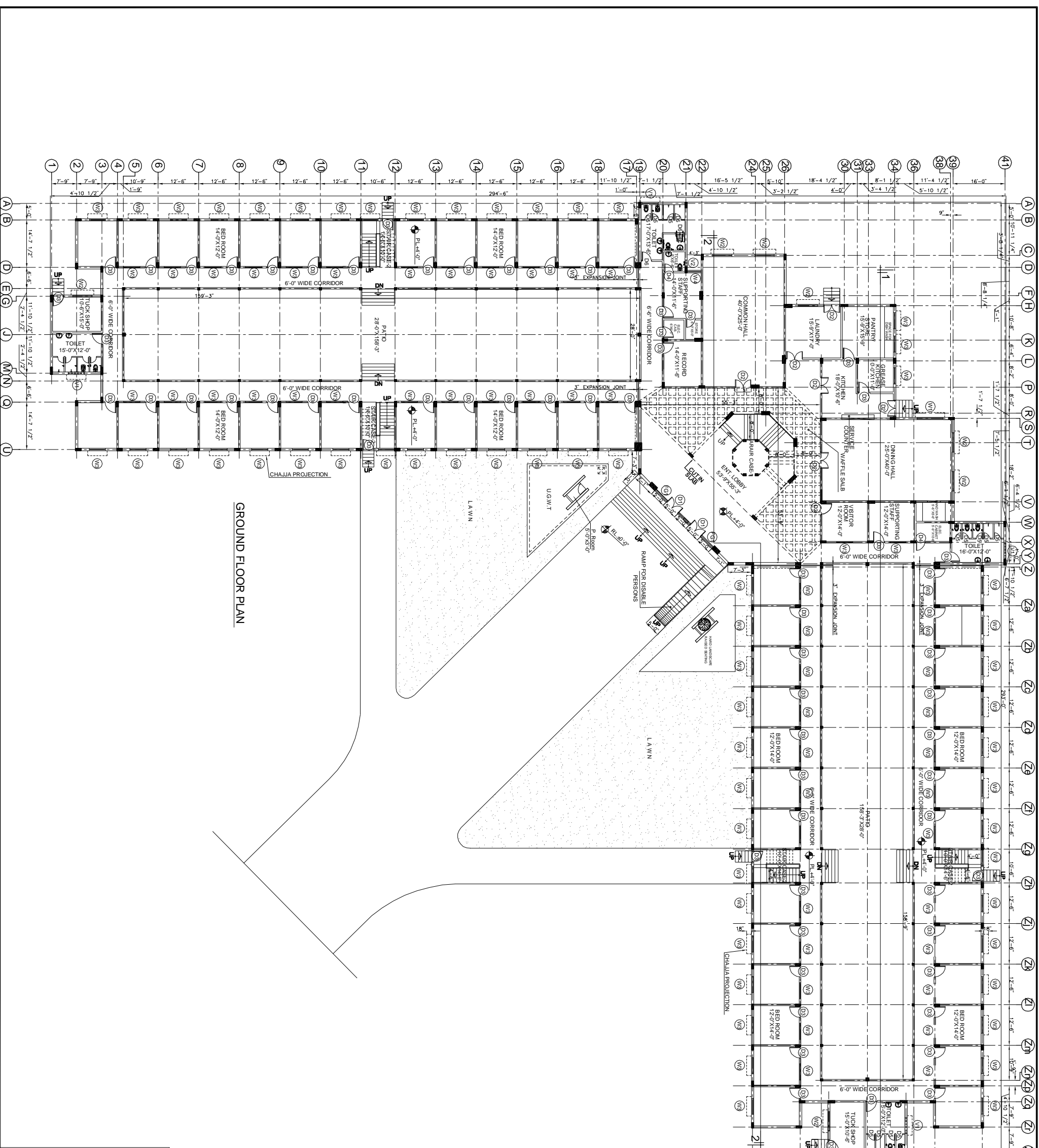

GROUND FLOOR PLAN

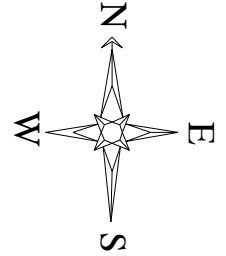

SCHEDULE OF DOORS, WINDOWS & VENTILATORS			DESCRIPTION
S.NO.	DOORS	SIZE	
D-1	5'-0"	7'-0"	ALUMINIUM GLAZED DOOR
D-2	5'-0"	7'-0"	WOODEN FLUSH DOOR
D-3	3'-6"	7'-0"	WOODEN FLUSH DOOR
D-4	2'-9"	7'-0"	WOODEN FLUSH DOOR
D-5	2'-0"	7'-0"	WOODEN FLUSH DOOR
D-6	3'-0"	7'-0"	WOODEN FLUSH DOOR
WINDOWS			
W-1	8'-0"	4'-0"	ALUMINIUM GLAZED WINDOW
W-2	6'-0"	4'-0"	ALUMINIUM GLAZED WINDOW
W-3	4'-0"	4'-0"	ALUMINIUM GLAZED WINDOW
W-4	4'-3"	4'-0"	ALUMINIUM GLAZED WINDOW
W-5	5'-0"	6'-6"	ALUMINIUM GLAZED WINDOW
W-6	25'-0"	4'-0"	ALUMINIUM GLAZED WINDOW
VENTILATORS			
V-1	5'-0"	2'-0"	ALUMINIUM GLAZED VEN.
V-2	2'-0"	2'-0"	ALUMINIUM GLAZED VEN.

3rd Revision : _____ Date : _____
 2nd Revision : _____ Date : _____
 1st Revision : _____ Date : _____
 ISSUED FOR : _____ TENDER DRAWING Date : 18-11-2021

CLIENT : LIAQUAT UNIVERSITY OF MEDICAL & HEALTH SCIENCES, JAMSHORO, SINDH PAKISTAN
 JOB TITLE : HOSTEL FOR MALE POST GRADUATE STUDENTS

DESCRIPTION : GROUND FLOOR PLAN

JOB NO. : 322
 DRG. NO. : 322-AR-102
 DRAWN BY : AMMR
 CHECKED BY : HUMM
 SCALE : 1" = 30'-0" DATE : 18-11-2021

YOUNG ASSOCIATES
 CONSULTING ENGINEERS & ARCHITECTS
 9-C-24th Commercial Street, Phase 2, I.E.M.I.,
 T-6, 1021, 3539644, 021-35312244
 E-mail: info@youngassociates.com.pk

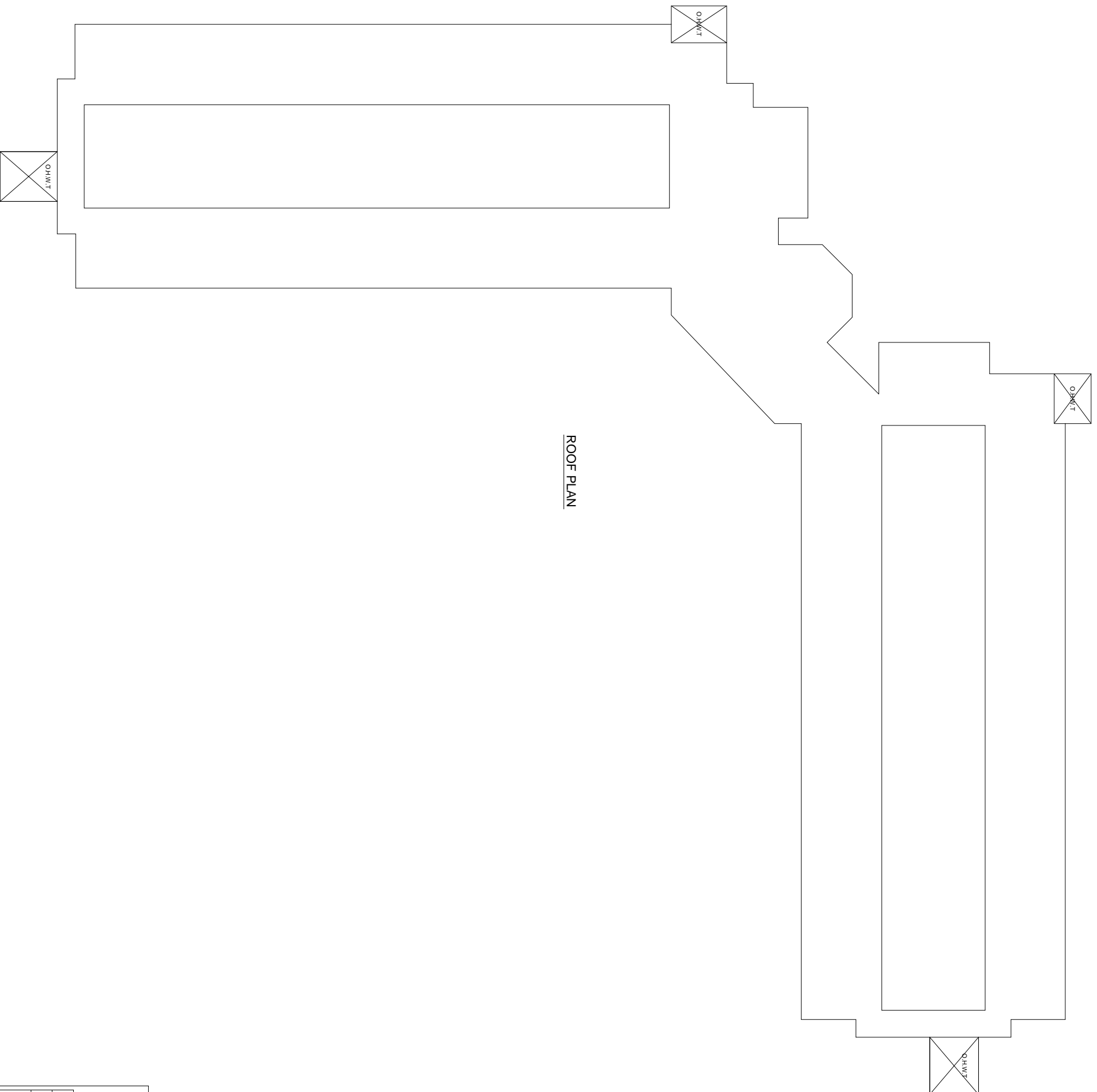
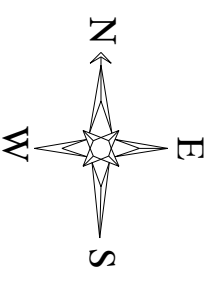

ROOF PLAN

3rd Revision :	Date :
2nd Revision :	Date :
1st Revision :	Date :
ISSUED FOR :	Date : 18-11-2021
CLIENT :	DESCRIPTION :
JOB TITLE :	ROOF PLAN
JOB NO. :	322
DRG. NO. :	322-AR-104
DRAWN BY :	CHECKED BY :
AMIR	HUMA
SCALE : 1"=30'-0"	DATE : 18-11-2021

YOUNG ASSOCIATES
CONSULTING ENGINEERS & ARCHITECTS
9-C 24 In Commercial Street, Phase 2 (E-9),
Defence Housing Authority, Karachi-75500
Tel : 021-35398444, 021-35312244
Fax: 021-35383106
E-mail: info@youngassociates.com.pk

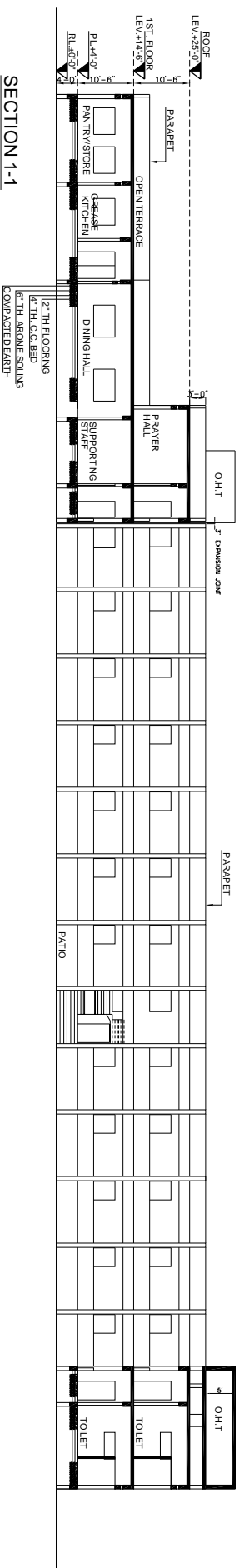
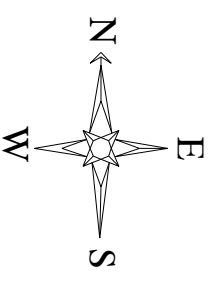

SECTION 1-1

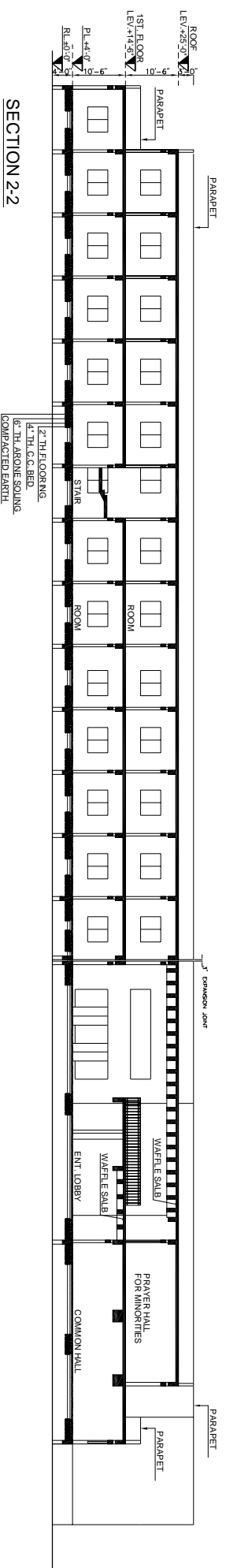

SECTION 2-2

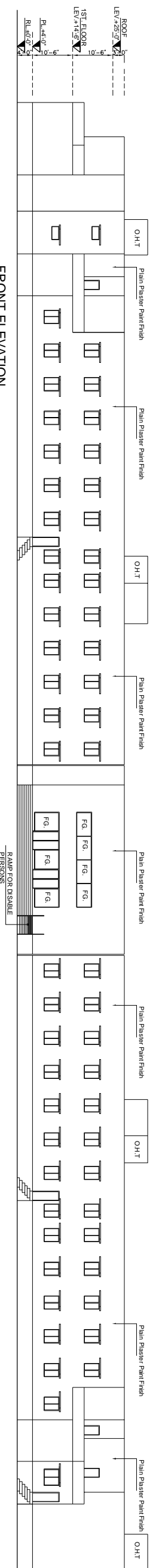

FRONT ELEVATION

3rd Revision :	Date :
2nd Revision :	Date :
1st Revision :	Date :
ISSUED FOR :	Date :
CLIENT :	DESCRIPTION :
JOB TITLE :	ELEVATION & SECTIONS
JOB NO. :	322
DRG. NO. :	322-AR-105
DRAWN BY :	AMMR
CHECKED BY :	HUMA
SCALE :	1"=30'-0"
DATE :	18-11-2021

YOUNG ASSOCIATES
 CONSULTING ENGINEERS & ARCHITECTS
 9-C 24 In Commercial Street, Phase 2 (Evo),
 Defence Housing Authority, Karachi-75500
 TEL: (021-35398444, 021-35312244
 FAX: (021-35383106
 E-mail: info@youngassociates.com.pk

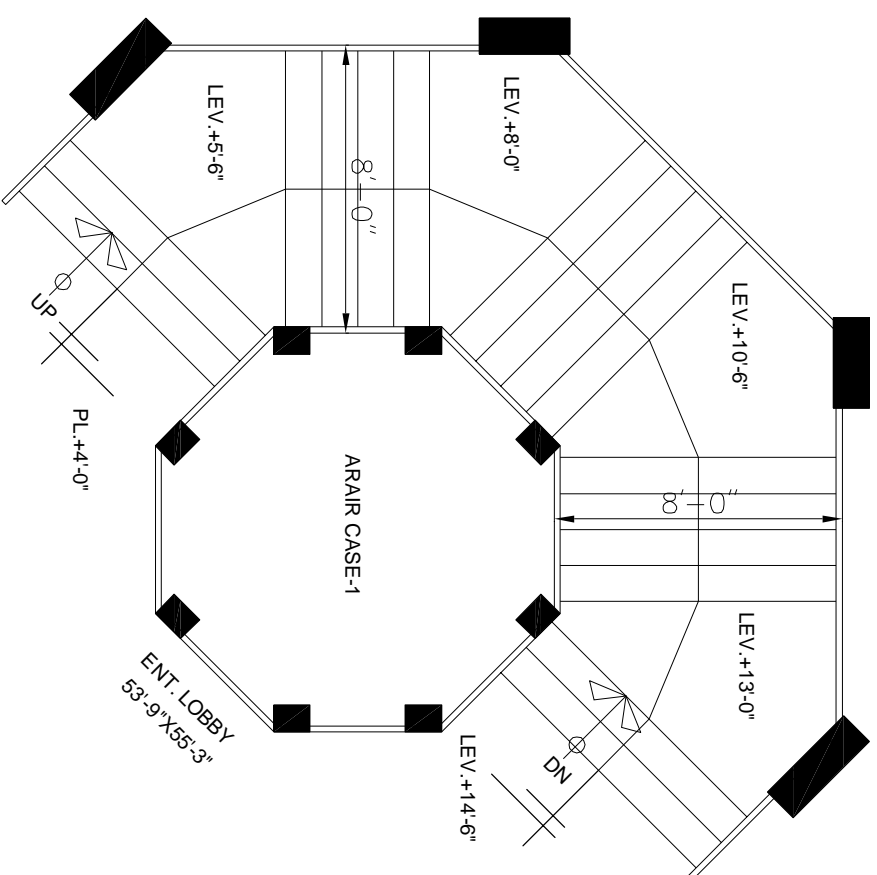
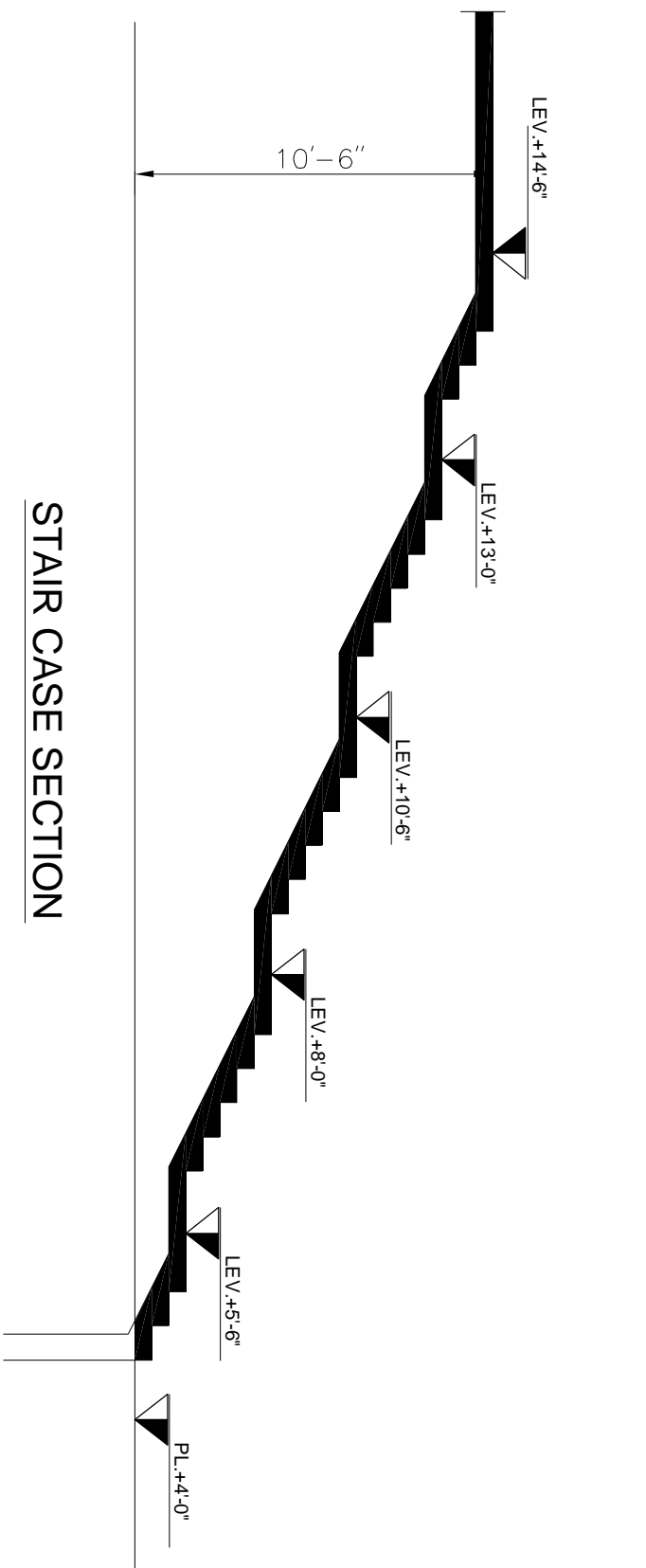

3rd Revision :	Date :	
2nd Revision :	Date :	
1st Revision :	Date :	
ISSUED FOR :	TENDER DRAWING	Date : 18-11-2021
CLIENT :	LAOQUAT UNIVERSITY OF MEDICAL & HEALTH SCIENCES, JAMSHORO, SINDH PAKISTAN	DESCRIPTION : STAIR CASE-1 PLAN & SECTION
JOB TITLE :	HOSTEL FOR MALE POST GRADUATE STUDENTS	JOB NO. : 322
YOUNG ASSOCIATES CONSULTING ENGINEERS & ARCHITECTS G-2/24th Commercial Street, Phase 2, I.E.M.P., JAMSHORO, SINDH PAKISTAN Tel : 021-3539644, 021-35312244 Fax: 021-35683106 E-mail: info@youngassociates.com.pk		DRG. NO. : 322-AR-106 DRAWN BY : HANIM CHECKED BY : HILMA SCALE : 1"=30'-0" DATE : 18-11-2021

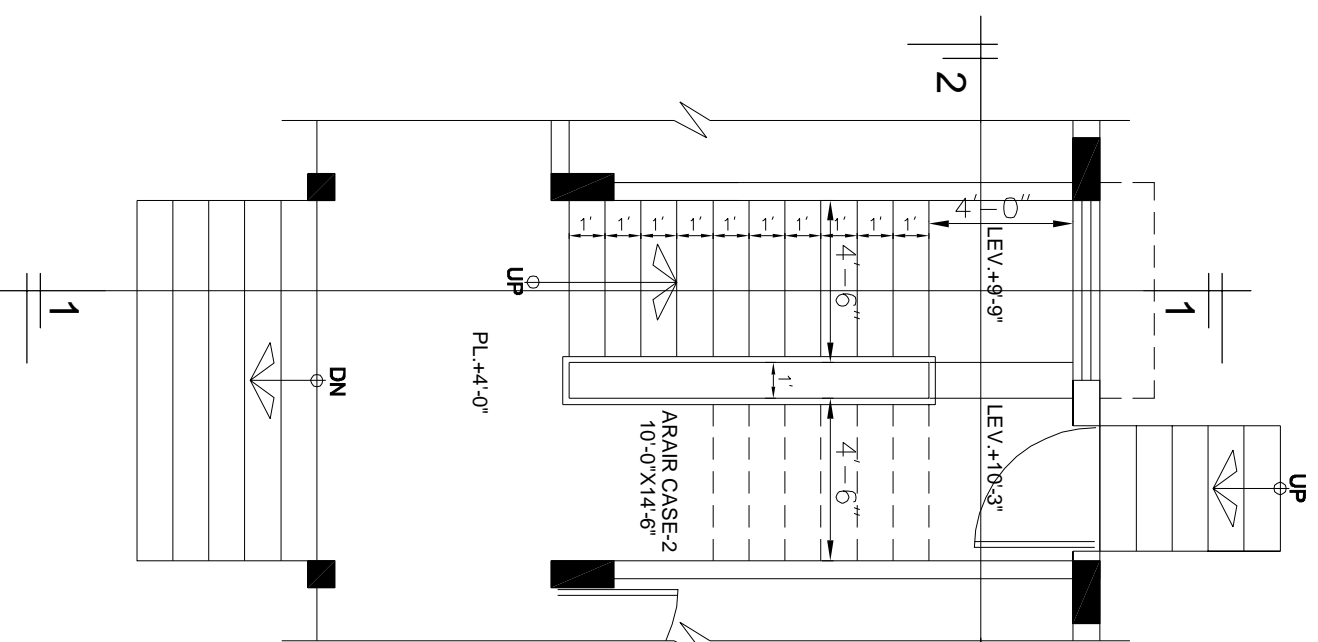

STAIR CASE -2 PLAN

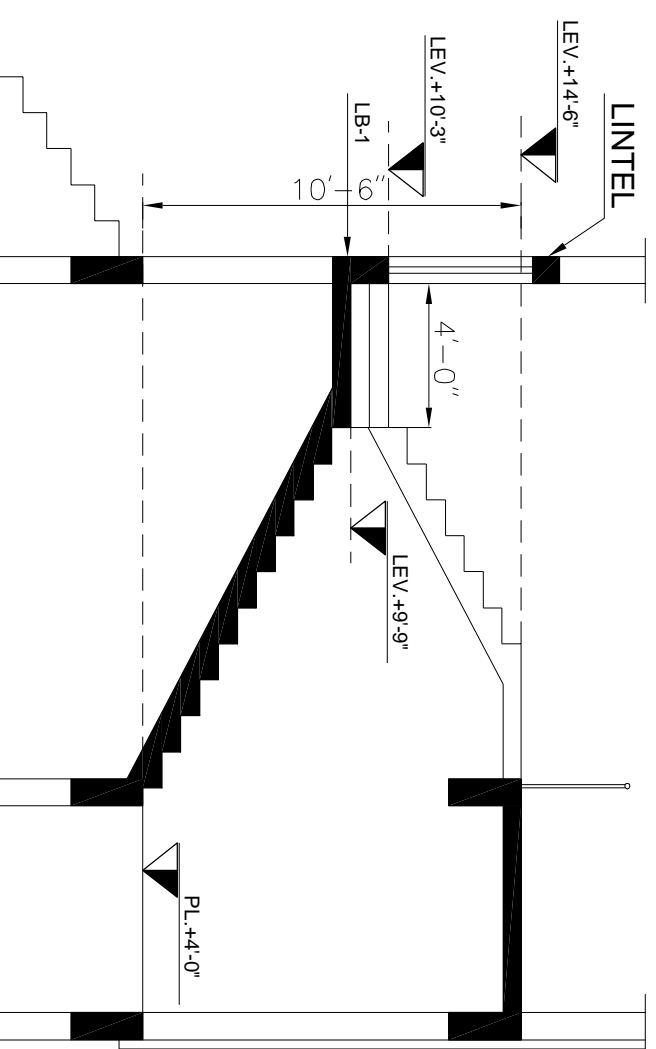

STAIR CASE SECTION 1-1

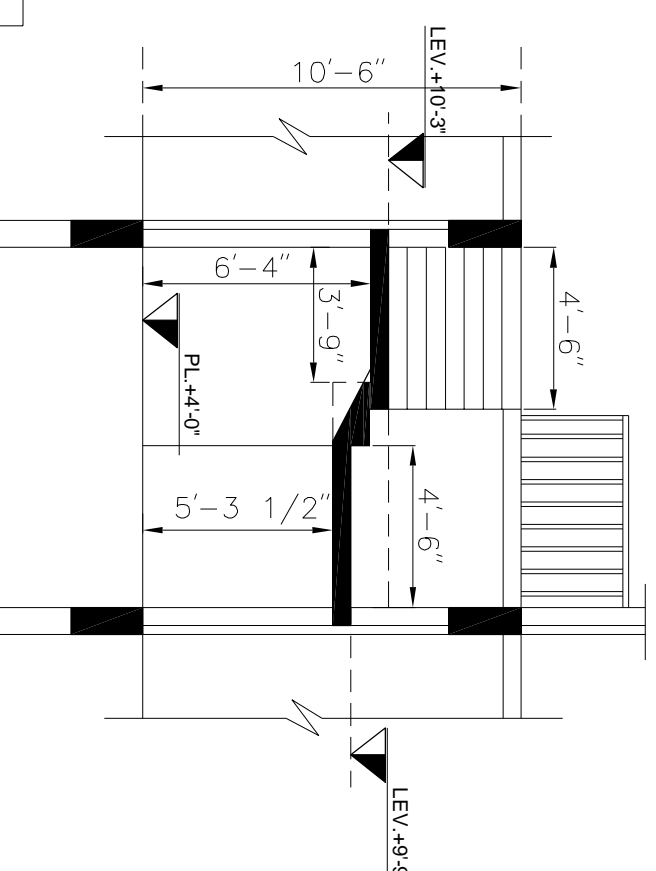

STAIR CASE SECTION 2-2

3rd Revision :	Date :
2nd Revision :	Date :
1st Revision :	Date :
ISSUED FOR :	Date :
CLIENT :	18-11-2021
JOB TITLE :	HOSTEL FOR MALE POST GRADUATE STUDENTS
ISSUED FOR :	TENDER DRAWING
CLIENT :	LIAQUAT UNIVERSITY OF MEDICAL & HEALTH SCIENCES, JAMSHORO, SINDH PAKISTAN
JOB TITLE :	STAIR CASE -2 PLAN & SECTION
JOB NO. :	322
DRG. NO. :	322-AR-07
DRAWN BY :	AAMIR
CHECKED BY :	HUMA
SCALE :	1"=30'-0"
DATE :	18-11-2021

YOUNG ASSOCIATES
 CONSULTING ENGINEERS & ARCHITECTS
 9-C 24 In Commercial Street, Phase 2 (E/W),
 Defence Housing Authority, Karachi-75500
 TEL: (021-3539844, 021-35312244
 FAX: (021-35383106
 E-mail: info@youngassociates.com.pk

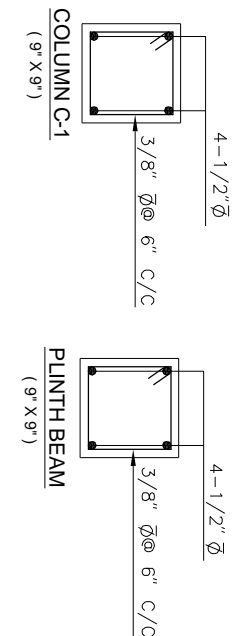
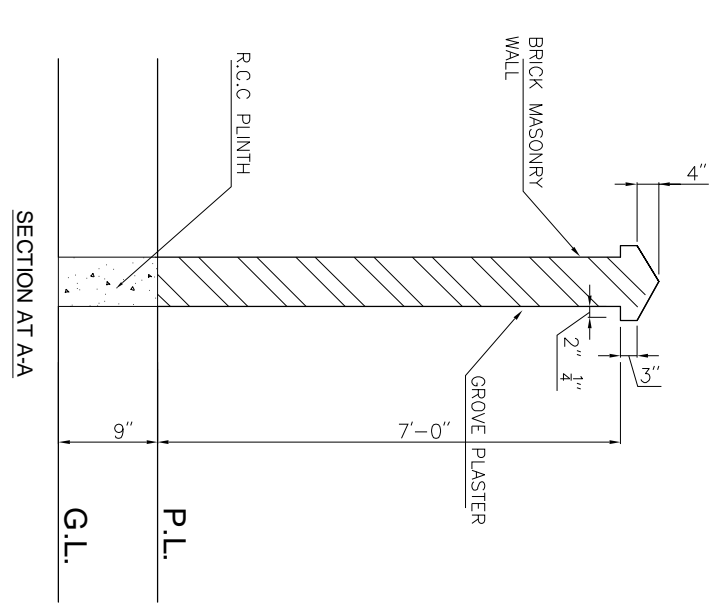
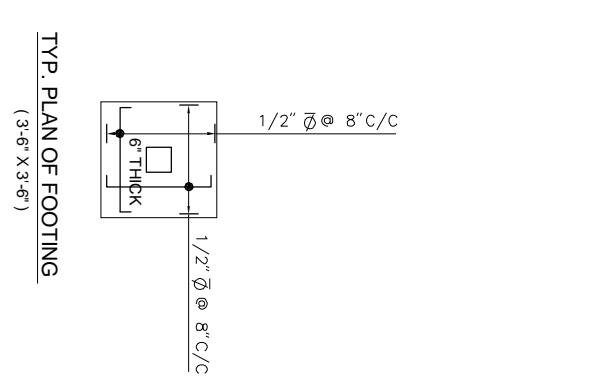
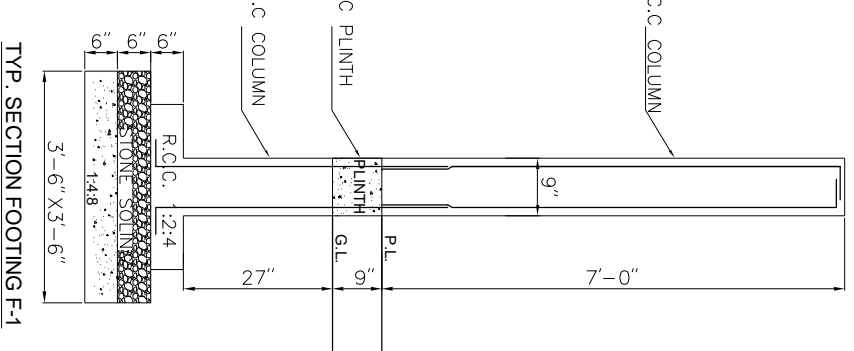
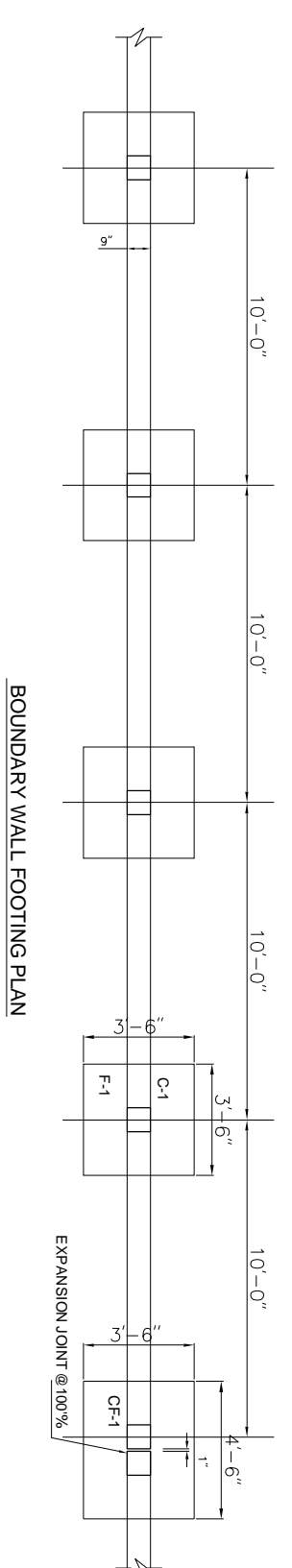
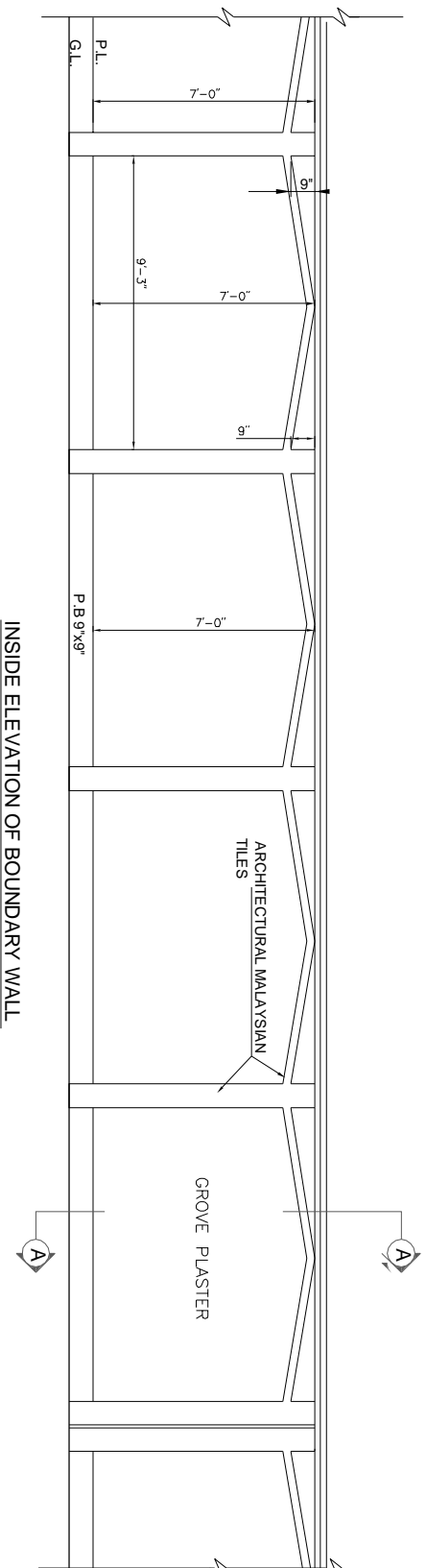

3rd Revision :	Date :
2nd Revision :	Date :
1st Revision :	Date :
ISSUED FOR :	Date :
TENDER DRAWING	18-11-2021
CLIENT :	LIQUAT UNIVERSITY OF MEDICAL & HEALTH SCIENCES, JAMSHORO, SINDH PAKISTAN
JOB TITLE :	HOSTEL FOR MALE POST GRADUATE STUDENTS
DESCRIPTION :	BOUNDARY WALL PLAN, ELEVATION, SECTION & REINFORCEMENT DETAILS
JOB NO. :	322
DRG. NO. :	322-AR-108
DRAWN BY :	AMMIR
CHECKED BY :	AMMIR
SCALE :	3/16"=1'-0"
DATE :	18-11-2021

YOUNG ASSOCIATES
CONSULTING ENGINEERS & ARCHITECTS
9-C 24 In Commercial street, Phase 2 (E-01),
Defence Housing Authority, Karachi-75500
Tel: (021-35398444, 021-35312244
Fax: (021-35383108
Email: (021-35398444@youngassociates.com.pk)

**LIAQAT UNIVERSITY OF MEDICAL & HEALTH SCIENCES (LUMHS), JAMSHORO
HOSTEL FOR MALE POST GRADUATE STUDENTS**

**TENDER DRAWINGS
STRUCTURAL DRAWINGS**

PREPARED BY:

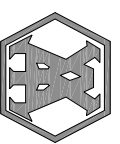

YOUNG ASSOCIATES
CONSULTING ENGINEERS & ARCHITECTS
9-C/24 th Commercial Street, Phase II (Extension) Defence Housing
Authority, Karachi-75500
Tel: 021-36396444, 021-36312244, FAX : 021-36883106
E-mail: info @ young associates .com.pk

LIST OF STRUCTURAL DRAWINGS

S.NO.	DWG. NO.	DESCRIPTION
1	322-ST-00	LI322-ST-OF DRAWINGS
2	GN-01	GENERAL NOTES
3	322-ST-101	COLUM LAYOUT PLAN
4	322-ST-102	COLUMN SECTION & REINFORCEMENT DETAILS
5	322-ST-103	FOOTING & REINFORCEMENT DETAILS
6	322-ST-104	PLINTH PALN & REINFORCEMENT DETAILS
7	322-ST-105	FIR322-ST-FLOOR FRAMMING PLAN & REINFORCEMENT DETAILS
8	322-ST-106	ROOF FRAMMING PLAN & REINFORCEMENT DETAILS

<p>3rd Revision : _____ Date : _____</p> <p>2nd Revision : _____ Date : _____</p> <p>1322-ST-Revision : _____ Date : _____</p> <p>ISSUED FOR : _____ TENDER DRAWING Date : 18-11-2021</p> <p>CLIENT : LAQIAT UNIVERSITY OF MEDICAL & HEALTH SCIENCES, JAMSHORO, SINDH PAKISTAN</p> <p>JOB TITLE : HOSTEL FOR MALE POAR GRADUATE STUDENTS</p>	<p>DESCRIPTION : LIST OF DRAWINGS</p> <p>JOB NO : 322</p> <p>DRG. NO : 322-ST-00</p> <p>DRAWN BY : MK. ABBAS</p> <p>CHECKED BY : ZEESHAN</p> <p>SCALE : NTS</p> <p>DATE : 18-11-2021</p>
--	--



YOUNG ASSOCIATES
CONSULTING ENGINEERS & ARCHITECTS
9-2/24-B Commercial Street, Phase 2 (J.E.O.),
Defence Housing Authority, Karachi-75500
Tel : 021-35396444, 021-35312244
FAX : 021-35863106
Email : info@youngassociates.com.pk

GENERAL NOTES

1. REINFORCED CONCRETE DESIGN IS BASED ON BUILDING CODE REQUIREMENT FOR REINFORCED CONCRETE UBC-97 AND ACI 318-08
2. FOUNDATION DESIGN IS BASED UPON A SAFE SOIL BEARING CAPACITY OF 2.9 T / SQ.FT. AT DEPTH OF 5'-0" BELOW N.G.L
3. COORDINATE STRUCTURAL DRAWINGS WITH ARCHITECTURAL DRAWINGS IN CASE OF DISCREPANCY REFER TO ENGINEER IN CHARGE
4. ALL DIMENSIONS ARE IN FEET/INCHES.
5. DO NOT SCALE THE DRAWING, FOLLOW WRITTEN DIMENSIONS OR REFER TO CONSULTANT
6. THE CONTRACTOR IS TO CHECK AND VERIFY ALL DIMENSIONS AND LEVELS BEFORE EXECUTION
7. ALL ERRORS AND OMISSIONS TO BE REFERRED TO THE CONSULTANT / ENGINEER PRIOR TO EXECUTION OF WORK
8. PRIOR TO CASTING CONCRETE REFER TO ARCHITECTURAL, PLUMBING, ELECTRICAL AND HVAC DRAWINGS FOR EMBEDDED ITEMS.
9. ALL MATERIALS SHALL COMPLY TO THE SPECIFICATIONS SHOWN ON THE DRAWINGS IN ABSENCE OF ANY SPECIFICATION ALL ABSENT MATERIALS SHOULD COMPLY TO RELEVANT ACI STANDARDS AND SHALL BE SUBJECTED TO APPROVAL OF THE CONSULTANT.
10. CONCRETE CUBES SHALL BE MADE AVAILABLE AT SITE BY THE CONTRACTOR AND SAMPLE FROM RANDOM BATCHES WILL BE TAKEN DURING CONCRETING.
11. SLUMP CONE SHALL BE MADE AVAILABLE AT SITE BY THE CONTRACTOR AND RANDOM SAMPLES WILL BE CHECKED DURING CONCRETING.
12. THE WATER USED FOR CONCRETE MIXING AND CURING SHOULD BE OF POTABLE QUALITY AND WITHOUT ANY IMPURITIES. A SAMPLE SHOULD BE TESTED IN LABORATORY FOR SULPHATE AND CHLORIDE CONTENTS.
13. FINE AND COARSE AGGREGATES SHOULD BE FREE FROM CLAY, LOAMS OR ANY OTHER ORGANIC IMPURITIES. A TEST-22-ST-SHOULD BE CARRIED OUT BEFORE USE.
14. ATMOSPHERIC TEMPERATURE SHOULD BE BETWEEN 32° C TO 35° C, AT THE TIME OF CONCRETE POURING.
15. R.C.C.CONCRETE (STANDARD CYLINDRICAL) STRENGTHS (fc IN PSI) AT 28 DAYS FOR VARIOUS STRUCTURAL MEMBERS SHALL BE.
 FOUNDATION/ BEAMS (fc = 3500 psi)
 COLUMNS (fc = 3500 psi)
 SLAB (fc = 3000 psi)
 LEAN CONCRETE (fc = 1500 psi)
16. ALL R.C.C. SPACE WORKS SHALL BE CONTINUOUSLY MOIST-22-ST-CURED FOR AT LEAST 22-ST-14 DAYS OR CURED BY CURING COMPOUND.
17. FORM WORK SUPPORTING R.C.C. MEMBERS SHALL NOT BE REMOVED PRIOR TO 14 DAYS, AFTER POURING.
18. ALL R.C.C. SPACE WORKS SHALL BE INTERNALLY VIBRATED WITH ELECTRO MECHANICAL VIBRATOR.
19. MINIMUM CLEAR CONCRETE COVER TO REINFORCEMENT SHALL BE AS FOLLOWS.
 FOUNDATION.....3"
 BEAMS 1 1/2"
 COLUMNS/WALLS 1 1/2" / 1"
 SLAB..... 3/4"
 WATER RETAINING STRUCTURES..... 2"
20. BEAMS AND SLABS SHOULD BE CASTED MONOLITHICALLY.
21. PRIOR TO PLACING CONCRETE ALL REINFORCING SHALL BE FREE OF LOOSE RUST-22-ST-AND SCALE OR ANY FOREIGN MATERIALS.
22. SPLICE LENGTH SHALL BE 60 TIMES DIA OF BAR
23. ALL INTERNAL & EXTERNAL PLASTER ON R.C.C. MEMBERS TO BE OF RATIO 1:4 AND THICKNESS SHOULD NOT EXCEED 3/4".

RECOMMENDED END HOOKS, ALL GRADES			
Bar Size	Finished bend diameter D/in.	180-deg hooks	
		A or G, in.	J, in.
#3	2 1/4	5	3
#4	3	6	4
#5	3 3/4	7	5
#6	4 1/2	8	6
#7	5 1/2	10	7
#8	6	11	8
#9	6 9/8	15	11 3/4
#10	10 3/4	17	13 1/2
#11	12	19	14 3/4
#14	18 1/4	27	21 3/4
#18	24	36	28 1/2

STIRRUP AND TIE HOOKS

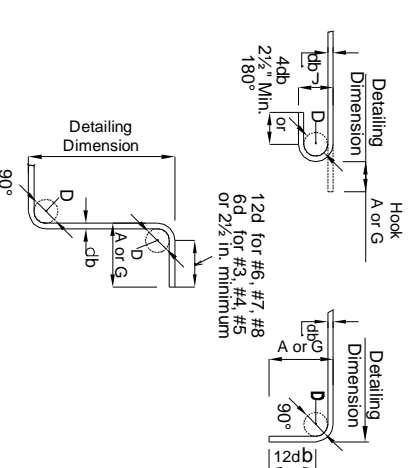

SEISMIC BEAM/COLUMN JOINT DETAIL

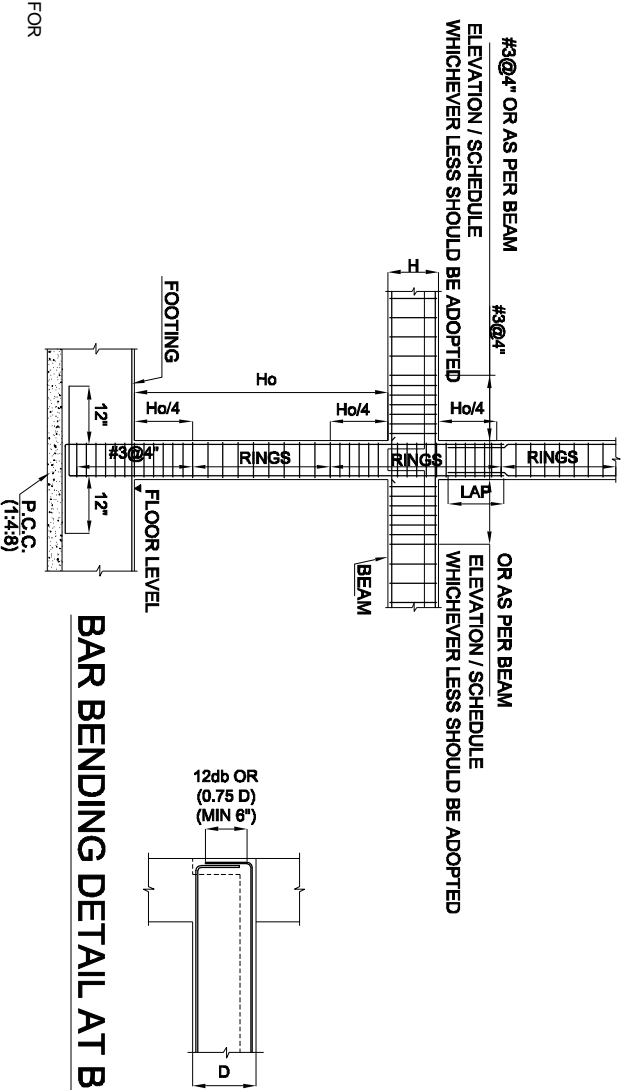

BAR BENDING DETAIL AT BEAM END

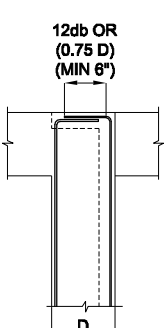

Bar Size	D (in.)	135-deg Stirrup-tie hook dimensions, in.	
		A or G, in.	H approx
#3	1 1/2	5	3 1/2
#4	2	6 1/2	4 1/2
#6	4 1/2	10 3/4	6 1/2

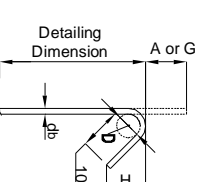
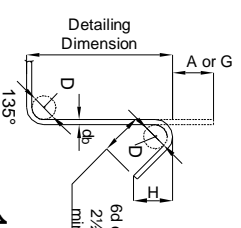

135-DEG SEISMIC

STIRRUP/TIE HOOKS

3rd Revision : _____	Date: _____
2nd Revision : _____	Date: _____
1322-ST-Revision : _____	Date: _____
ISSUED FOR : _____	Date: 18-11-2021
TENDER DRAWING	
CLIENT : LAQAT UNIVERSITY OF MEDICAL & HEALTH SCIENCES, JAMSHORO, SINDH PAKISTAN	DESCRIPTION : GENERAL NOTES
JOB TITLE : HOSTEL FOR MALE POST GRADUATE STUDENTS	
JOB NO : 322	
DRG. NO. : GN01	
DRAWN BY : MK, ABBASI	CHECKED BY : ZEE SHAN
SCALE : NTS	DATE : 18-11-2021

YOUNG ASSOCIATES
 CONSULTING ENGINEERS & ARCHITECTS
 9-C 24 th Commercial street, Phase 2 (Ekm),
 Defence Housing Authority, Karachi-75500
 Tel : 021-35396444, 021-35312244
 Fax : 021-38883106
 Email : info@youngassociates.com.pk

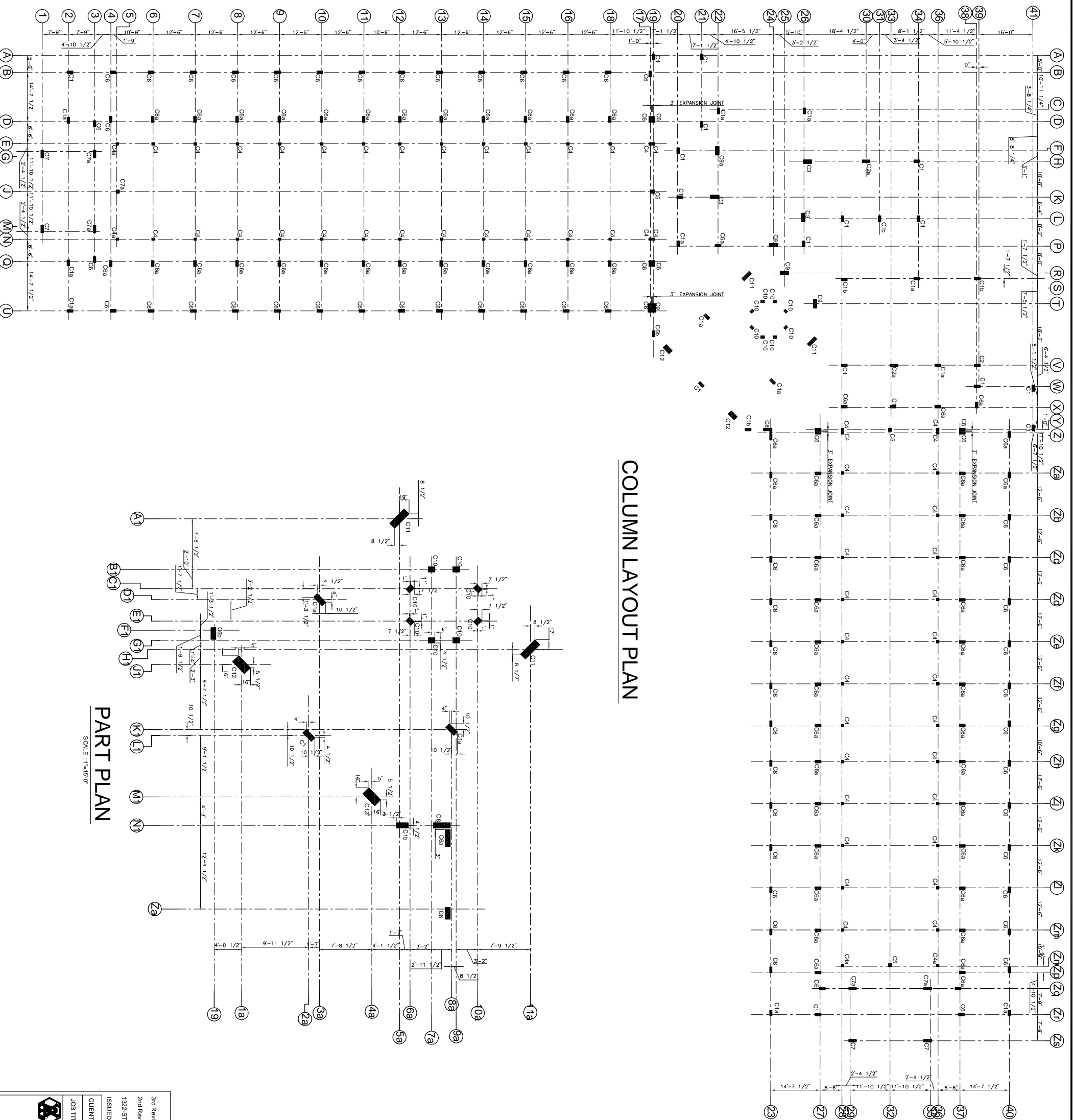

COLUMN LAYOUT PLAN

PART PLAN

SCALE: 1"=15'-0"

3rd Revision:	Date:	18-11-2021
2nd Revision:	Date:	
1322-ST-Revision:	Date:	
ISSUED FOR:	TENDER DRAWING	Date:
CLIENT:	LAQUAT UNIVERSITY OF MEDICAL & HEALTH SCIENCES, JAMSHORO, SINDH PAKISTAN	DESCRIPTION:
JOB TITLE:	HOSTEL FOR MALE POST GRADUATE STUDENTS	COLUMN LAYOUT PLAN
YOUNG ASSOCIATES	JOB NO.: 322	DRG. NO.: 322-ST-101
CONSULTING ENGINEERS & ARCHITECTS	9-C 24 th Commercial street, Phase 2 (Ekm), Defence Housing Authority, Karachi-75500	DRAWN BY: M.K. ABBASI
Tel: 021-35389844, 021-35312244		CHECKED BY: ZEESHAN
Email: info@youngassociates.com.pk		SCALE: 1"=30'-0"
		DATE: 18-11-2021

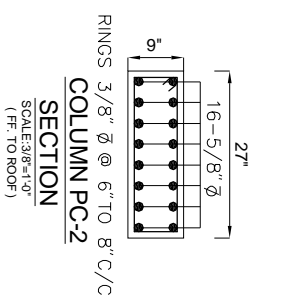
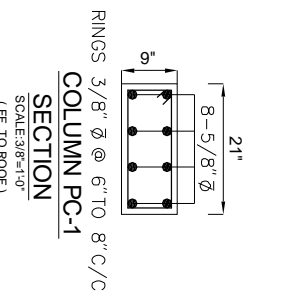
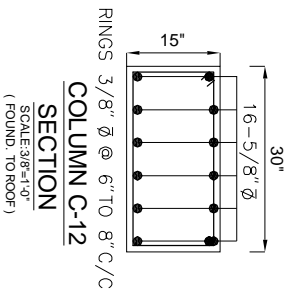
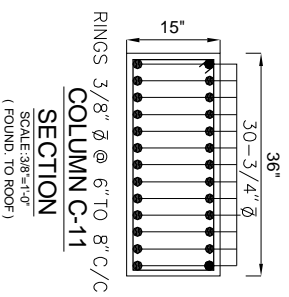
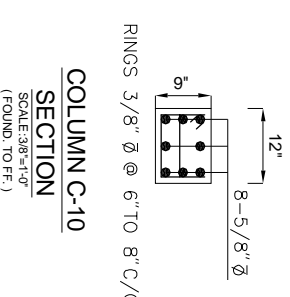
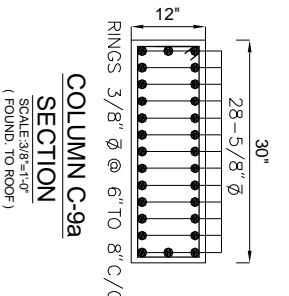
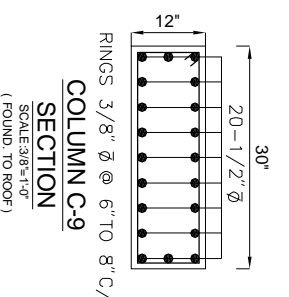
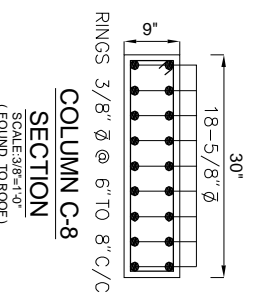
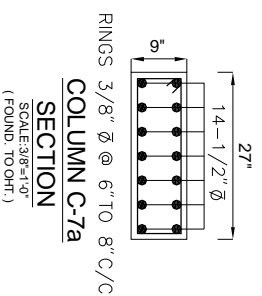
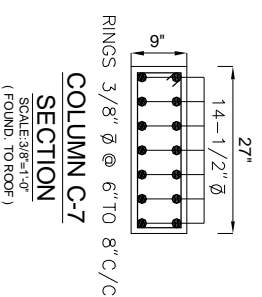
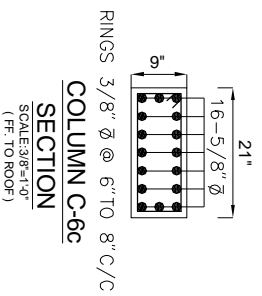
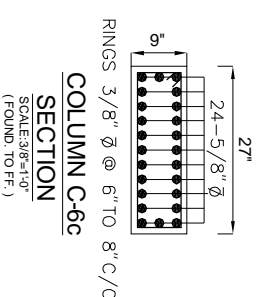
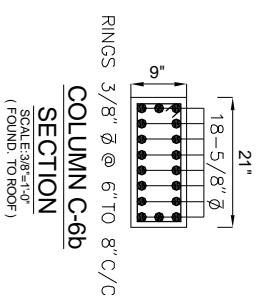
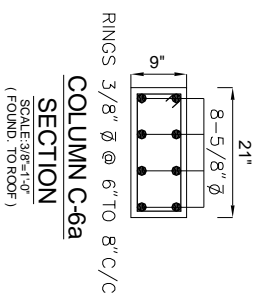
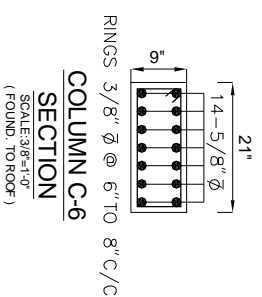
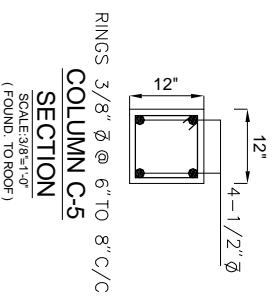
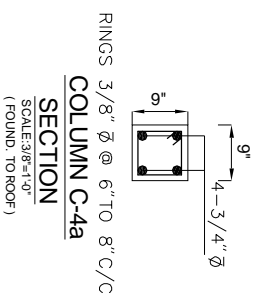
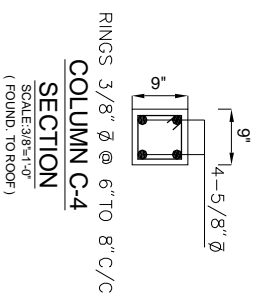
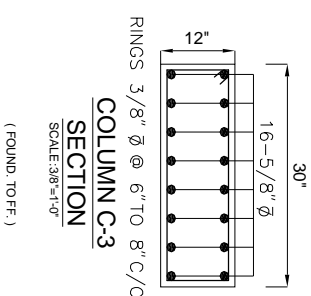
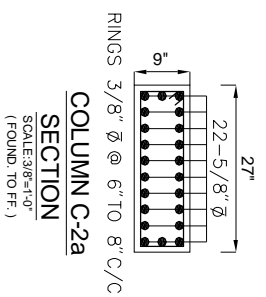
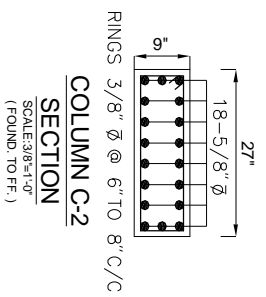
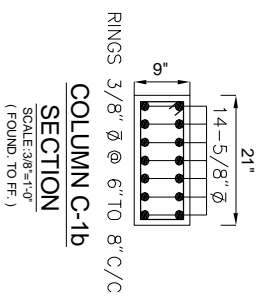
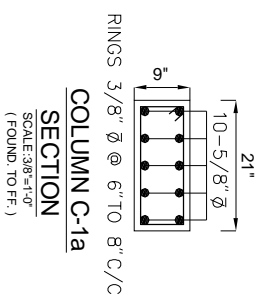
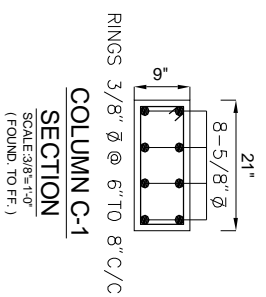

3rd Revision :	Date :	18-11-2021
2nd Revision :	Date :	
1322-ST-Revision :	Date :	
ISSUED FOR :	TENDER DRAWING	Date : 18-11-2021
CLIENT :	LAQUAT UNIVERSITY OF MEDICAL & HEALTH SCIENCES, JAMSHORO, SINDH PAKISTAN	DESCRIPTION : COLUMN SECTIONS & REINFORCEMENT DETAILS
JOB TITLE :	HOSTEL FOR MALE POST GRADUATE STUDENTS	JOB NO. : 322
YOUNG ASSOCIATES CONSULTING ENGINEERS & ARCHITECTS 9-C 24 th Commercial street, Phase 2 (Ekm), Differce Housing Authority, Karachi-75500 Tel : 021-35389844, 021-35312244 Fax : 021-35389844 Email: info@youngassociates.com.pk		DRG. NO. : 322-ST-102 DRAWN BY : M.K. ABBASI CHECKED BY : ZEESHAN SCALE : 3/8"=1'-0" DATE : 18-11-2021

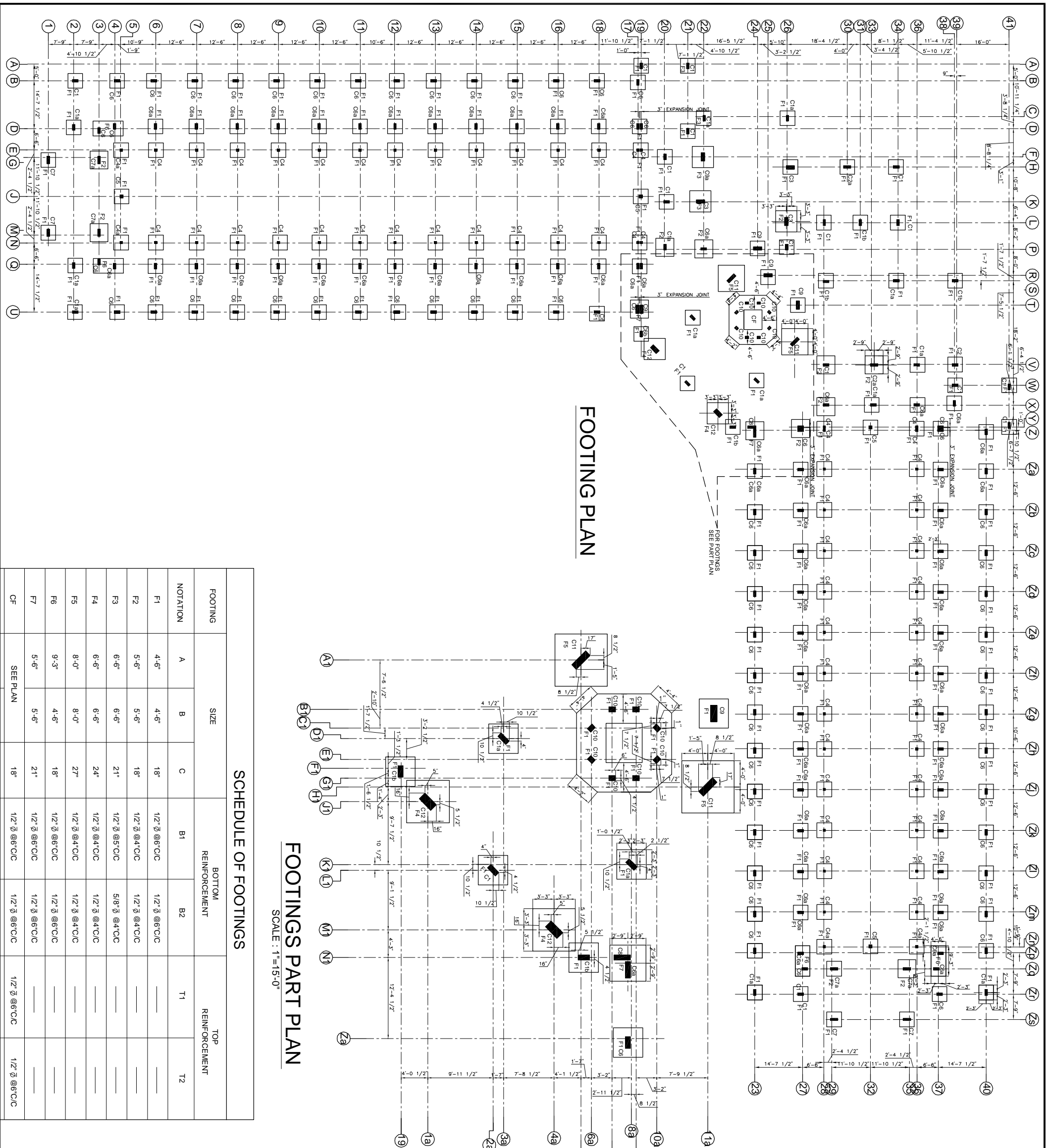

FOOTING PLAN

FOOTINGS PART PLAN
SCALE : 1"=15'-0"

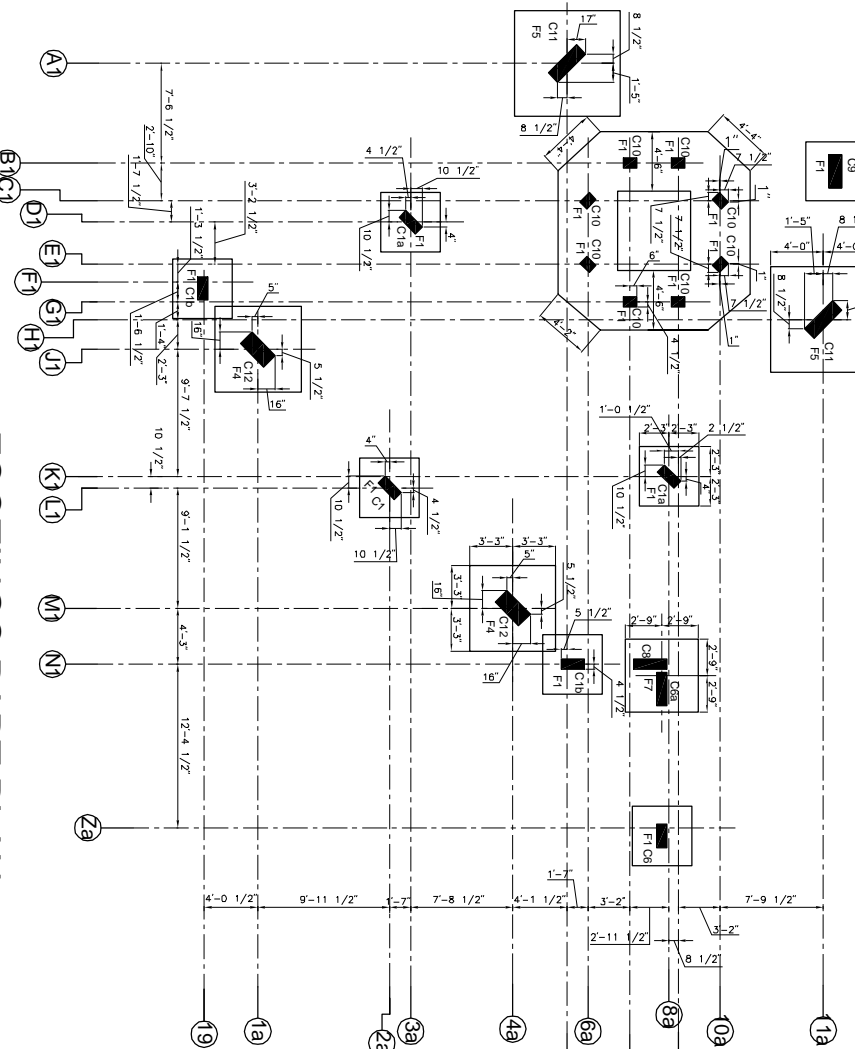

SCHEDULE OF FOOTINGS

FOOTING NOTATION	SIZE		BOTTOM REINFORCEMENT		TOP REINFORCEMENT	
	A	B	B1	B2	T1	T2
F1	4'-6"	4'-6"	1/2" ∅ @6"C/C	1/2" ∅ @6"C/C		
F2	5'-6"	5'-6"	1/2" ∅ @4"C/C	1/2" ∅ @4"C/C		
F3	6'-6"	6'-6"	1/2" ∅ @5"C/C	5/8" ∅ @4"C/C		
F4	6'-6"	6'-6"	1/2" ∅ @4"C/C	1/2" ∅ @4"C/C		
F5	8'-0"	8'-0"	1/2" ∅ @4"C/C	1/2" ∅ @4"C/C		
F6	9'-3"	4'-6"	1/2" ∅ @6"C/C	1/2" ∅ @6"C/C		
F7	5'-6"	5'-6"	1/2" ∅ @6"C/C	1/2" ∅ @6"C/C		
CF	SEE PLAN		1/2" ∅ @6"C/C	1/2" ∅ @6"C/C	1/2" ∅ @6"C/C	1/2" ∅ @6"C/C

TYPICAL PLAN OF ISOLATED FOOTING
SCALE : 1"=7'-0"

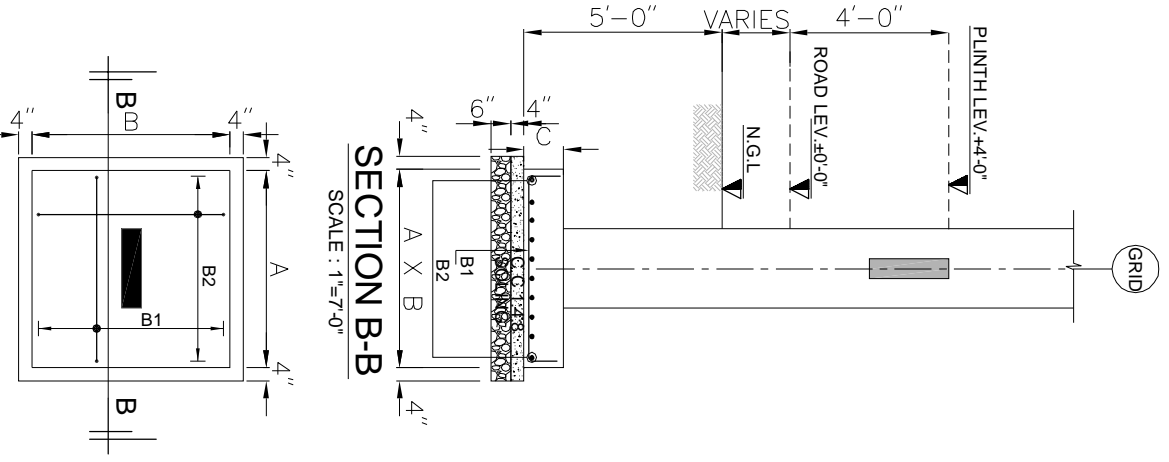

SECTION B-B
SCALE : 1"=7'-0"

3rd Revision : _____ Date: _____

2nd Revision : _____ Date: _____

1322-ST-Revision : _____ Date: _____

ISSUED FOR: TENDER DRAWING Date: 18-11-2021

JOB TITLE: HOSTEL FOR MALE POST GRADUATE STUDENTS

CLIENT: LAQUAT UNIVERSITY OF MEDICAL & HEALTH SCIENCES, JAMSHORO, SINDH PAKISTAN

CONSULTING ENGINEERS & ARCHITECTS
YOUNG ASSOCIATES
 9-C 24 th Commercial street, Phase 2, Ekmil, Defence Housing Authority, Karachi-75500
 Tel: 021-35389844, 021-35312244
 Email: info@youngassociates.com.pk

DESCRIPTION: FOOTING PLAN & REINFORCEMENT DETAILS

JOB NO.: 322

DRG. NO.: 322-ST-103

DRAWN BY: MK, ABBASI

CHECKED BY: ZEESHAN

SCALE: 3/8"=1'-0" DATE: 18-11-2021

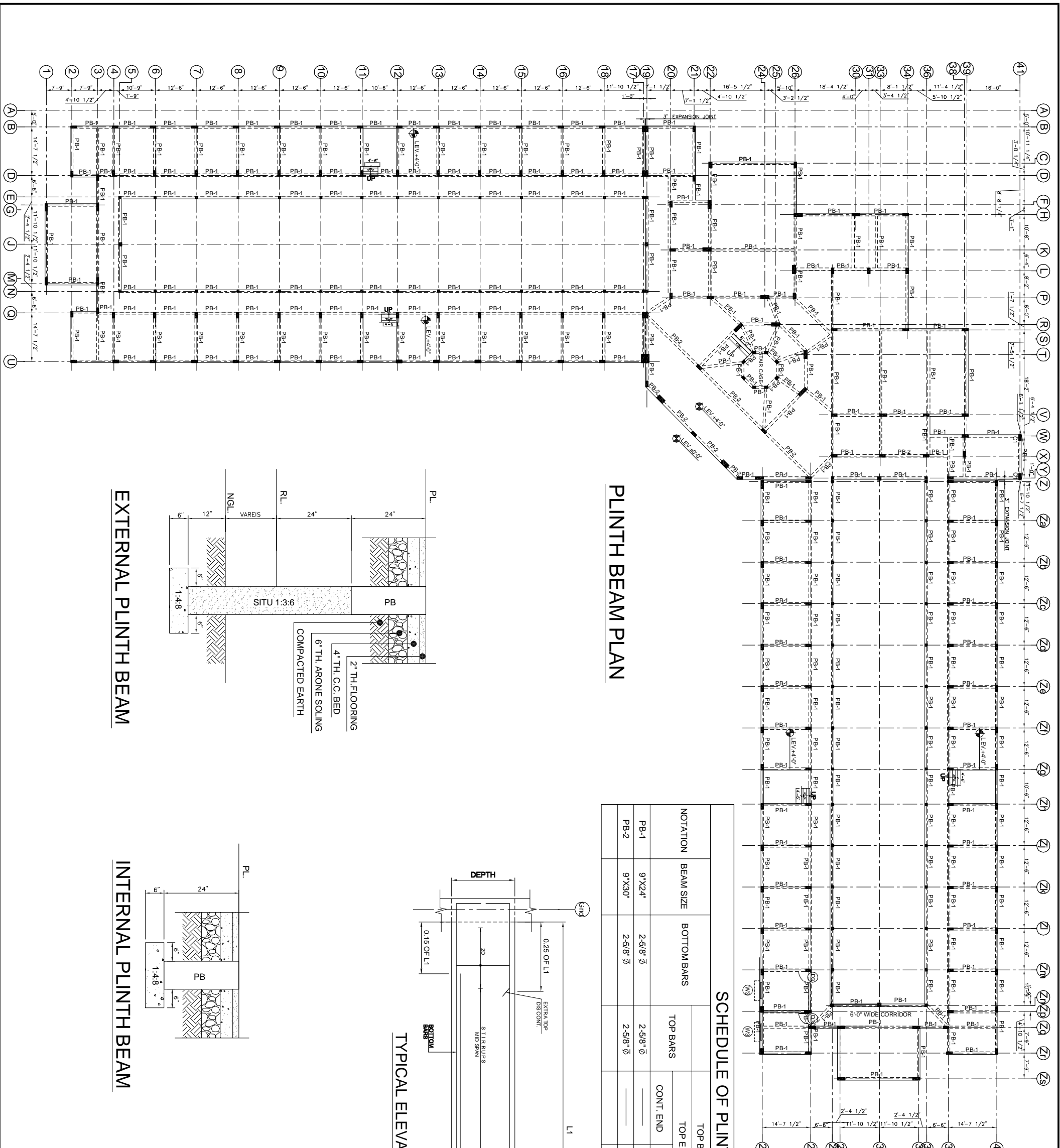

PLINTH BEAM PLAN

EXTERNAL PLINTH BEAM

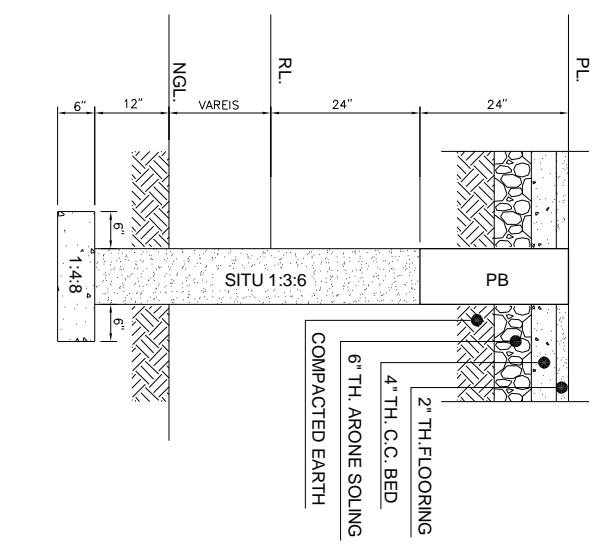

INTERNAL PLINTH BEAM

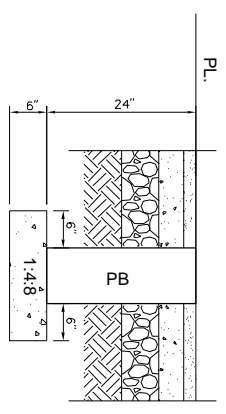

TYPICAL ELEVATION OF BEAM

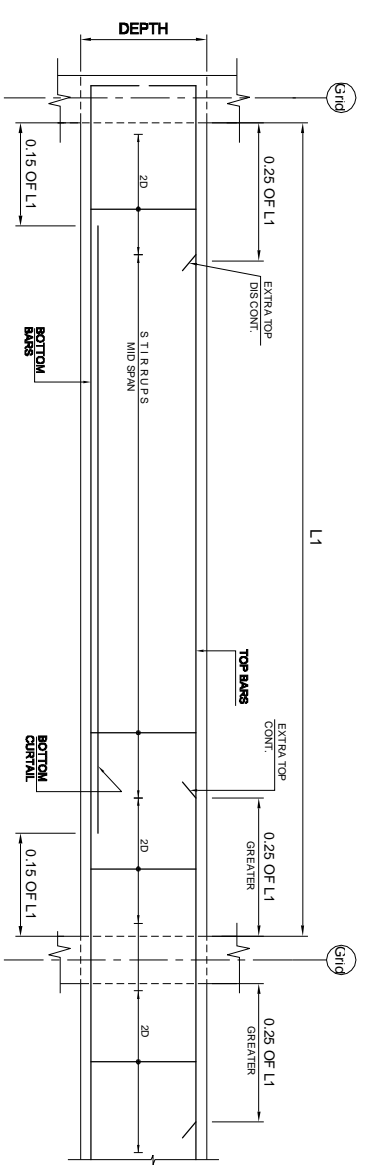

NOTATION	BEAM SIZE	BOTTOM BARS	TOP BARS		REMARKS
			CONT. END	DISCONT. END	
PB-1	9"X24"	2-5/8" ∅	2-5/8" ∅	3/8" ∅ @ 8" C/C	3/8" ∅ @ 6" C/C
PB-2	9"X30"	2-5/8" ∅	2-5/8" ∅	3/8" ∅ @ 8" C/C	3/8" ∅ @ 6" C/C

SCHEDULE OF PLINTH BEAMS

3rd Revision : _____	Date : _____
2nd Revision : _____	Date : _____
1322-ST-Revision : _____	Date : _____
ISSUED FOR : _____	DATE : 18-11-2021
TENDER DRAWING	
YOUNG ASSOCIATES	
CONSULTING ENGINEERS & ARCHITECTS	
9-C 24th Commercial Street, Phase 2, Ekmf,	
Difference Housing Authority, Karachi-75500	
Tel: 021-35389144, 021-35312244	
Fax: 021-35389144, 021-35312244	
Email: info@youngassociates.com.pk	
JOB TITLE : HOSTEL FOR MALE POST GRADUATE STUDENTS	
CLIENT : LAQUAT UNIVERSITY OF MEDICAL & HEALTH SCIENCES, JAMSHORO, SINDH PAKISTAN	
DESCRIPTION : PLINTH BEAM PLAN & REINFORCEMENT DETAILS	
JOB NO. : 322	
DRG. NO. : 322-ST-104	
DRAWN BY : M.K. ABBASI	CHECKED BY : ZEESHAN
SCALE : 1"=30'-0"	DATE : 18-11-2021

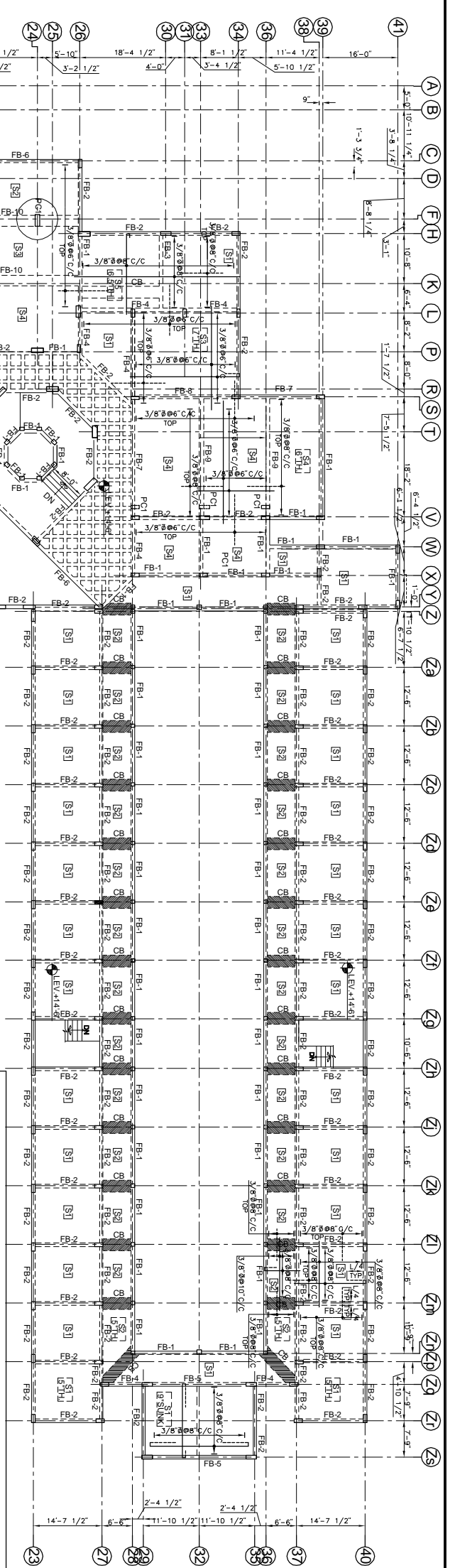

FIRST FLOOR FRAMING

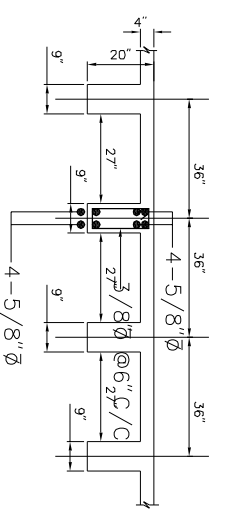

TYP. SECTION FIRST FLOOR WAFLE SLAB
SCALE : 1"=7'-0"

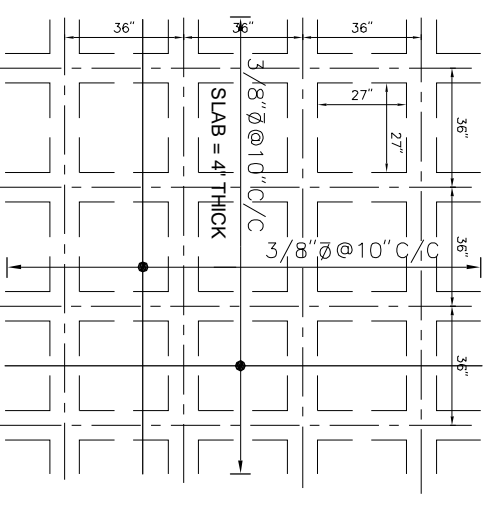

TYP. FIRST FLOOR WAFLE SLAB PLAN
SCALE : 1"=7'-0"

SCHEDULE OF FIRST FLOOR BEAMS

NOTATION	BEAM SIZE	BOTTOM BARS	TOP BARS		REMARKS
			TOP EXTRA	DISCONT. END	
FB-1	9"X24"	2-5/8" ∅	2-5/8" ∅		3/8" ∅ @ 8"C/C
FB-2	9"X30"	2-5/8" ∅	2-5/8" ∅		3/8" ∅ @ 8"C/C
FB-3	9"X24"	4-5/8" ∅	2-5/8" ∅		3/8" ∅ @ 8"C/C
FB-4	9"X24"	2-5/8" ∅	2-5/8" ∅		3/8" ∅ @ 8"C/C
FB-5	9"X24"	2-5/8" ∅	3-5/8" ∅		3/8" ∅ @ 8"C/C
FB-6	9"X30"	3-5/8" ∅	3-5/8" ∅		3/8" ∅ @ 8"C/C
FB-7	9"X30"	3-5/8" ∅	2-5/8" ∅		3/8" ∅ @ 8"C/C
FB-8	9"X30"	7-5/8" ∅	3-5/8" ∅		3/8" ∅ @ 8"C/C
FB-9	12"X30"	7-5/8" ∅	4-5/8" ∅		3/8" ∅ @ 8"C/C
FB-10	15"X30"	9-5/8" ∅	9-1/2" ∅		3/8" ∅ @ 4"C/C
FB-11	15"X30"	4-5/8" ∅	5-5/8" ∅		3/8" ∅ @ 4"C/C
FB-12	21"X27"	7-5/8" ∅	7-5/8" ∅		3/8" ∅ @ 4"C/C
CB-1	30"X6"	5-5/8" ∅	5-5/8" ∅		3/8" ∅ @ 6"C/C

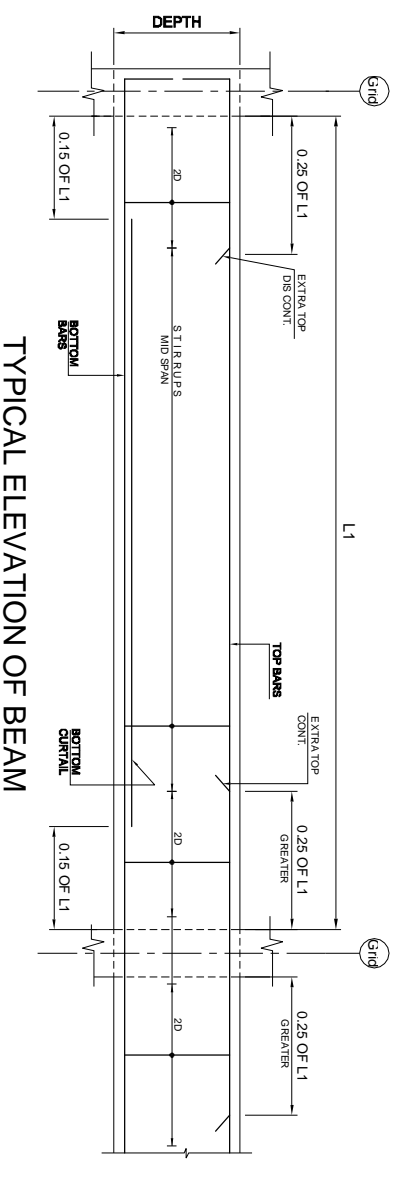

TYPICAL ELEVATION OF BEAM

3rd Revision : _____ Date : _____
 2nd Revision : _____ Date : _____
 1st Revision : _____ Date : _____
 ISSUED FOR : TENDER DRAWING Date : 18-11-2021

YOUNG ASSOCIATES
 CONSULTING ENGINEERS & ARCHITECTS
 9-C 24 th Commercial street, Phase 2 (Ekm),
 Defence Housing Authority, Karachi-75500
 Tel: 021-3538944, 021-35312244
 Email: info@youngassociates.com.pk

JOB TITLE : HOSTEL FOR MALE POST GRADUATE STUDENTS
 CLIENT : LAQUAT UNIVERSITY OF MEDICAL & HEALTH SCIENCES, JAMSHORO, SINDH PAKISTAN
 DESCRIPTION : FR322-ST-FLOOR FRAMING PLAN & REINFORCEMENT DETAILS
 JOB NO. : 322
 DRG. NO. : 322-ST-105
 DRAWN BY : M.K. ABBASI
 CHECKED BY : ZEESHAN
 SCALE : 1"=30'-0" DATE : 18-11-2021

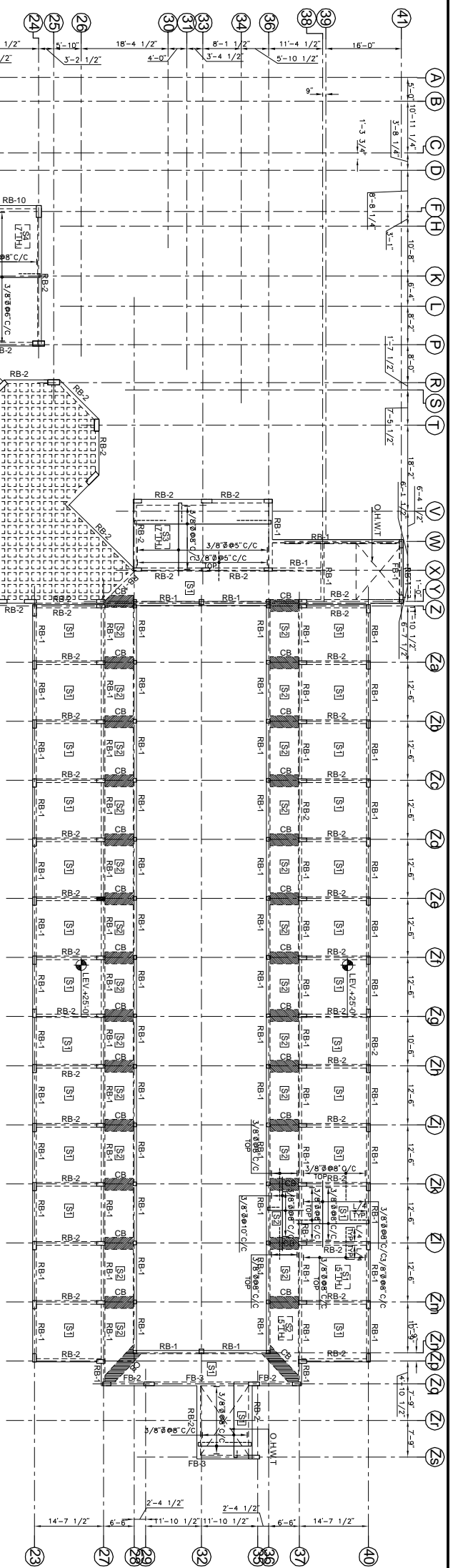

ROOF FRAMING

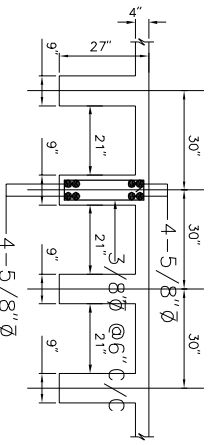

TYP. SECTION ROOF WAFFLE SLAB
SCALE : 1"=7'-0"

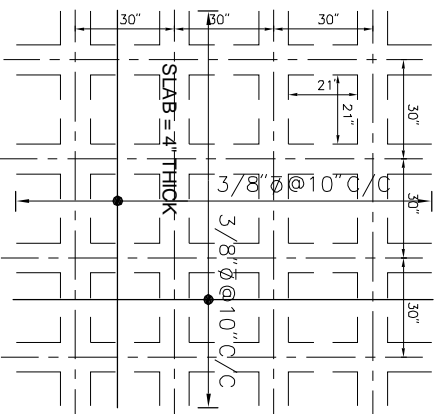

TYP. ROOF WAFFLE SLAB PLAN
SCALE : 1"=7'-0"

SCHEDULE OF ROOF BEAMS

NOTATION	BEAM SIZE	BOTTOM BARS	TOP BARS		REMARKS
			CONT. END	DISCONT. END	
RB-1	9"X24"	2-5/8" ∅	2-5/8" ∅	3/8" ∅ @ 8" C/C	RINGS @ L4
RB-2	9"X24"	2-5/8" ∅	1-5/8" ∅	3/8" ∅ @ 8" C/C	RINGS @ CENTER
RB-3	9"X24"	3-5/8" ∅	2-5/8" ∅	3/8" ∅ @ 5" C/C	
RB-4	9"X30"	3-5/8" ∅	3-5/8" ∅	3/8" ∅ @ 5" C/C	
RB-5	15"X30"	5-5/8" ∅	5-5/8" ∅	3/8" ∅ @ 5" C/C	

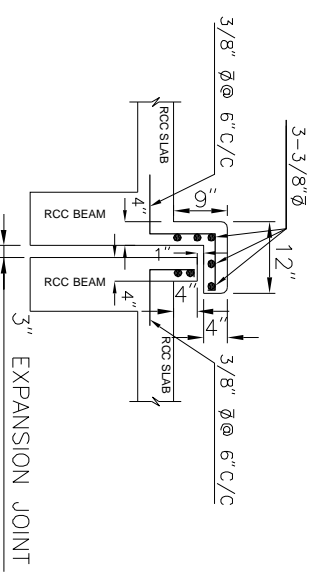
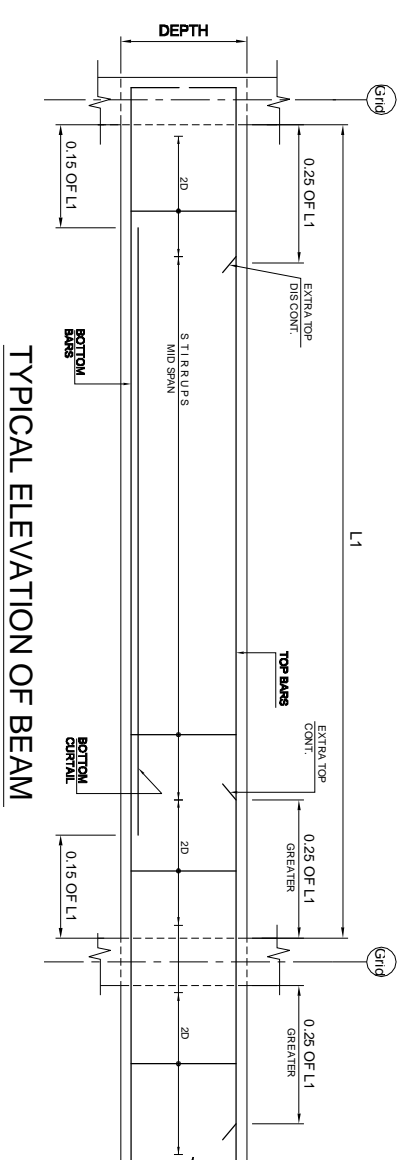

TYP. DETAIL OF EXPANSION JOINT
SCALE : 1"=7'-0"

3rd Revision : _____ Date : _____	1322-ST-Revision : _____ Date : _____	ISSUED FOR : TENDER DRAWING	DATE : 18-11-2021
2nd Revision : _____ Date : _____	1322-ST-Revision : _____ Date : _____	ISSUED FOR : TENDER DRAWING	DATE : 18-11-2021
YOUNG ASSOCIATES CONSULTING ENGINEERS & ARCHITECTS 9-C 24 th Commercial street, Phase 2 (Ekm), Defence Housing Authority, Karachi-75500 Tel: 021-35389444, 021-35312244 Email: info@youngassociates.com.pk		DESCRIPTION: ROOF FRAMING PLAN & REINFORCEMENT DETAILS	
CLIENT: LAQUAT UNIVERSITY OF MEDICAL & HEALTH SCIENCES, JAMSHORO, SINDH PAKISTAN		JOB NO.: 322 DRG. NO.: 322-ST-106 DRAWN BY: MK. ABBASI CHECKED BY: ZEESHAN SCALE: _____ DATE: 18-11-2021	
JOB TITLE : HOSTEL FOR MALE POST GRADUATE STUDENTS		JOB NO.: 322	

**LIAQAT UNIVERSITY OF MEDICAL & HEALTH SCIENCES (LUMHS), JAMSHORO
HOSTEL FOR MALE POST GRADUATE STUDENTS**

**TENDER DRAWINGS
PLUMBING DRAWINGS**

PREPARED BY:

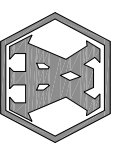

YOUNG ASSOCIATES
CONSULTING ENGINEERS & ARCHITECTS
9-C/24 th Commercial Street, Phase II (Extension) Defence Housing
Authority, Karachi-75500
Tel: 021-36396444, 021-36312244, FAX : 021-36883106
E-mail: info @ young associates .com.pk







" MECHANICAL LIST OF DRAWINGS "

SHEET NO	DESCRIPTION	ISSUED
M-000	MECHANICAL LIST OF DRAWINGS, NOTES & LEGENDS	✓
M-001	MECHANICAL DETAILS	✓
M-002	HVAC LAYOUT FOR GROUND FLOOR	✓
M-003	HVAC LAYOUT FOR FIRST FLOOR	✓
M-004	DRAINAGE LAYOUT FOR GROUND FLOOR	✓
M-005	DRAINAGE LAYOUT FOR FIRST FLOOR	✓
M-006	DRAINAGE LAYOUT FOR ROOF FLOOR	✓
M-007	DRAINAGE ENLARGE PLANS	✓
M-008	WATER SUPPLY LAYOUT FOR GROUND FLOOR	✓
M-009	WATER SUPPLY LAYOUT FOR FIRST FLOOR	✓
M-010	WATER SUPPLY LAYOUT FOR ROOF FLOOR	✓
M-011	WATER SUPPLY ENLARGE PLANS	✓

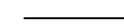
GENERAL NOTES:

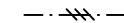
- DO NOT SCALE THE DRAWINGS. THE LOCATIONS OF ALL ITEMS ARE APPROXIMATE ONLY. THE EXACT LOCATIONS NECESSARY TO SECURE THE BEST CONDITIONS AND RESULTS WILL BE DETERMINED BY THE SITE CONDITIONS
- FLOOR PLANS SHALL BE READ IN CONJUNCTION WITH SCHEMATICS
- VERIFY STRUCTURAL INTEGRITY OF ALL TEMPORARY AND PERMANENT OPENINGS. ADDITIONAL FRAMING TO ENSURE STRUCTURE INTEGRITY SHALL BE INCLUDED UNDER THIS CONTRACT
- REFER TO STANDARD DETAILS FOR ADDITIONAL INFORMATION
- SCHEMATICS SHALL BE READ IN CONJUNCTION WITH FLOOR PLANS.
- CONTRACTOR SHALL VERIFY AND ENSURE ALL PIPING FITTINGS AND COMPONENTS ARE SUITABLE AS PER SITE CONDITIONS
- IT IS THE CONTRACTOR RESPONSIBILITY TO ENSURE ALL COMPONENTS ARE LOCATED AND DESIGNED TO WITHSTAND ALL STATIC AND DYNAMIC LOADING.

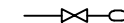
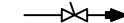
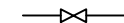
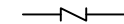
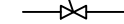





LEGEND

	INCOMING CITY WATER
	COLD WATER MAIN SUPPLY
	COLD WATER SUPPLY
	HOT WATER SUPPLY
	BURIED COLD WATER SUPPLY
	MUSLIM SHOWER
	FLOAT VALVE
	HOSE BIB (HB)
	GATE VALVE
	CHECK VALVE
	BALL VALVE
	SOLENOID VALVE
	GAS HOT WATER

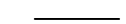
ABBREVIATIONS

FD	FLOOR DRAIN
RWP	RAIN WATER PIPE
SS	SOIL STACK
WS	WASTE STACK
RWS	RAIN WATER STACK
VP	VENT PIPE
COP	CLEAN OUT PLUG
F/A	FROM ABOVE
T/B	TO BLOW
T/A	TO ABOVE
F/B	FROM BELOW
I.L.	INVERT LEVEL
MH	MANHOLE

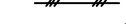
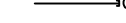
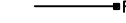
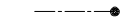
LEGEND

	WASTE PIPE
	SOIL PIPE
	VENT PIPE
	BURIED PIPE
	CLEAN OUT PLUG
	FLOOR CLEAN OUT
	VENT COWL (ROOF TYPE)
	FLOOR DRAIN
	GULLEY TRAP
	MANHOLE

2nd Revision : _____	Date : _____
1st Revision : _____	Date : _____
ISSUED FOR : _____	Date : 20-11-2021
CLIENT: LANGKAT UNIVERSITY OF MEDICAL & HEALTH SCIENCES, JAMBEKOR, BENGKAL PARIWISATA	DESCRIPTION: LIST OF DRAWINGS, NOTES & LEGENDS
JOB TITLE: HOSTEL FOR MALE POST GRADUATE STUDENTS	JOB NO: 202
YOUNG ASSOCIATES CONSULTING ENGINEERS & ARCHITECTS 8-C-24 B, Commercial Area, Phase 2 (Block) Dulurus Housing Authority, Muar, Johor Tel: 07-851-8284, 07-851-8284 FAX: 07-851-8284 Email: info@youngassociates.com.my	ENGR. NO.: 0204-000
	DRAWN BY: SPK
	CHECKED BY: SPK
	SCALE: NTD
	DATE: 03-09-2021

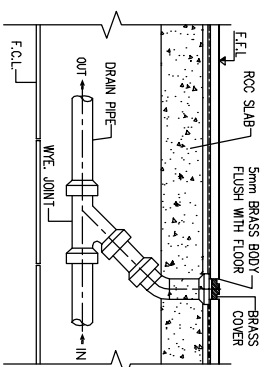

1) DETAIL OF FLOOR CLEAN OUT PLUG (FCO)
SCALE: NTS

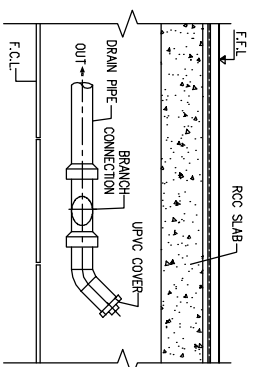

2) DETAIL OF CEILING TYPE CLEAN OUT PLUG (COP)
SCALE: NTS

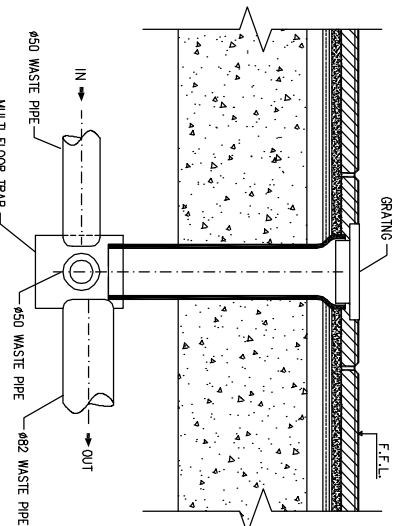

3) DETAIL OF MULTI FLOOR TRAP WITH GRATING
SCALE: NTS

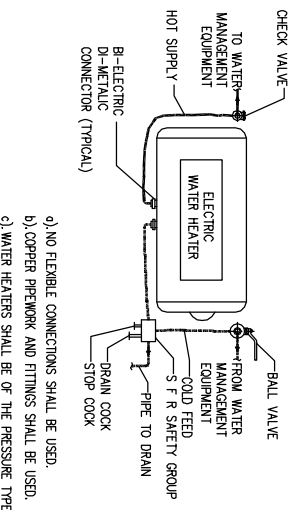

- a) NO FLEXIBLE CONNECTIONS SHALL BE USED.
- b) COPPER PIPERWORK AND FITTINGS SHALL BE USED.
- c) WATER HEATERS SHALL BE OF THE PRESSURE TYPE SUITABLE FOR NON-VENTED SYSTEMS.
- d) S.F.R SAFETY GROUP PIPED TO DRAIN WITH COPPER PIPE.

4) DETAIL OF WATER HEATER CONNECTION
SCALE: NTS

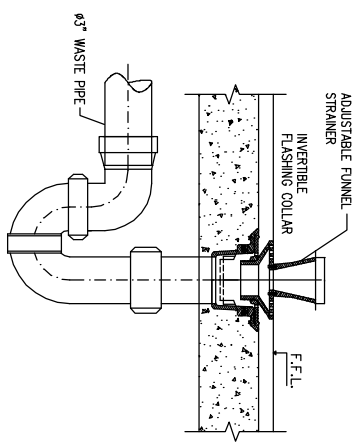

5) FUNNEL/STRAINER W/ROUND BODY W/STRAINER W/ROUND FUNNEL EQUIPMENT FLOOR DRAIN
SCALE: NTS

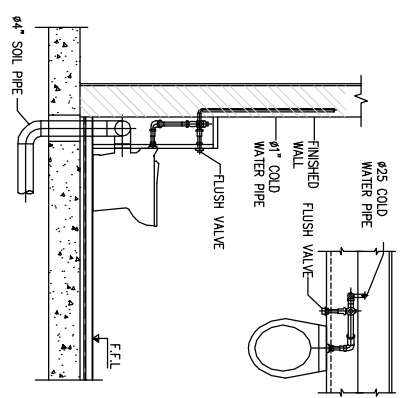

6) DETAIL OF WATER CLOSET CONNECTION
SCALE: NTS

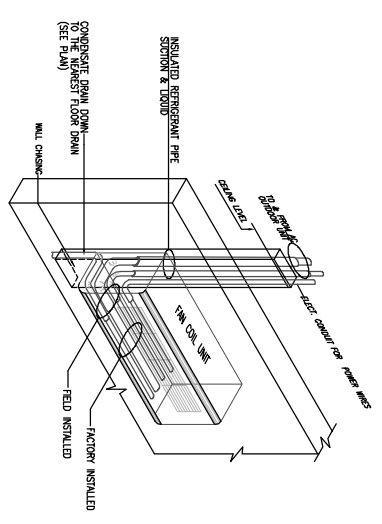

7) INSTALLATION OF SPLIT AC UNIT
SCALE: NTS

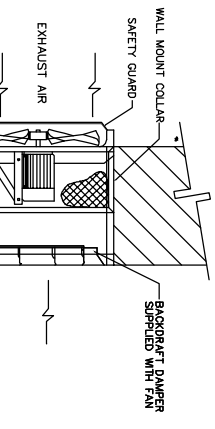

9) WALL FAN DETAIL
SCALE: NTS

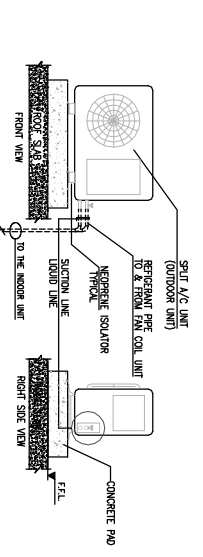

10) AIR - COOLED CONDENSING MOUNTING DETAIL
SCALE: NTS

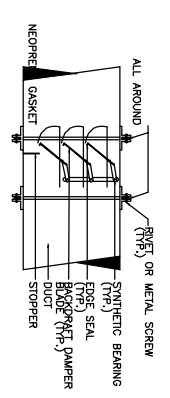

8) PIPE INSULATION DETAIL
SCALE: NTS

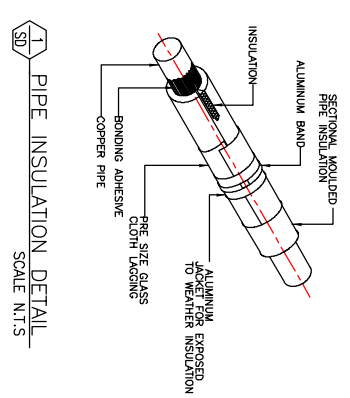

12) CO2 FIRE EXTINGUISHER
SCALE: NTS

GENERAL NOTES

1. THE CONTRACTOR SHALL COMPLY WITH THE CURRENT BS (*OR RELEVANT ASTM)S) WITH RESPECT TO ANY MATERIALS OR WORK NOT SPECIFIED IN DETAIL IN THE CONSULTANT'S SPECIFICATIONS OR DRAWINGS.
2. THE PLUMBING SYSTEM DRAWINGS SHALL BE READ IN CONJUNCTION WITH THE CORRESPONDING ARCHITECTURAL, FIRE PROTECTION, ELECTRICAL, SANITARY, HVAC AND STRUCTURAL DRAWINGS. ANY DISCREPANCY SHALL BE BROUGHT TO THE CONSULTANT ENGINEER'S ATTENTION PRIOR TO CONSTRUCTION.
3. IT IS THE CONTRACTOR'S RESPONSIBILITY TO ENSURE LOCATION OF ALL DRAINAGE EQUIPMENT DUCTING AND PIPING ETC. FORMING PART OF THIS CONTRACT IS COORDINATED WITH:
 - a) ALL ARCHITECTURAL & REFLECTED CEILING PLANS
 - b) ALL OTHER MEP SERVICES.
 - c) STRUCTURAL MEMBERS
4. DO NOT SCALE THE DRAWINGS. ALL DIMENSIONS SHALL BE READ FROM THE DRAWINGS OR COMPUTED.
5. ALL EQUIPMENT AND DEVICES SHALL BE U.I. APPROVED (OR HAVE AN EQUIVALENT CERTIFICATION, WHERE REQUIRED)
6. ALL DIMENSIONS SHOWN ARE FOR GUIDANCE & FROM FINISHED FLOOR/WALL. MAKE NECESSARY DIMENSIONAL ALLOWANCES.
7. ALL WORK SHALL COMPLY WITH ALL APPLICABLE LOCAL, STATE AND HEALTH CODES.
8. LEAVE PROVISION FOR ALL A.C CONDENSATE DRAINS (FOR MAINTENANCE PURPOSES) TO BE CONNECTED IN BUILDINGS.
9. ALL DIMENSIONS ARE IN I.P.I. UNITS UNLESS OTHERWISE INDICATED.
10. FIRE EXTINGUISHERS SHALL BE INSTALLED AS PER NFPA CODE

3rd Revision:	Date:	
2nd Revision:	Date:	
1st Revision:	Date:	
ISSUED FOR:	TENDER DRAWING	Date: 22-11-2021
CLIENT:	LIQAQAT UNIVERSITY OF MEDICAL & HEALTH SCIENCES, JAMSHORO, SINDH PAKISTAN	DESCRIPTION: MECHANICAL STANDARDS DETAILS
JOB TITLE:	HOSTEL FOR MALE POST GRADUATE STUDENTS	JOB NO.: 332
CONSULTING ENGINEERS & ARCHITECTS:	YOUNG ASSOCIATES	DRG. NO.: 322M-001
9-C 24th Commercial Atrium, Phase 2 (E/M), Defence Housing Authority, Karachi-75500	Phone: (021-35386444, 021-35312244	DRAWN BY: SSW
Email: info@youngassociates.com.pk		CHECKED BY: SHK
		SCALE: NTS
		DATE: 05-06-2021

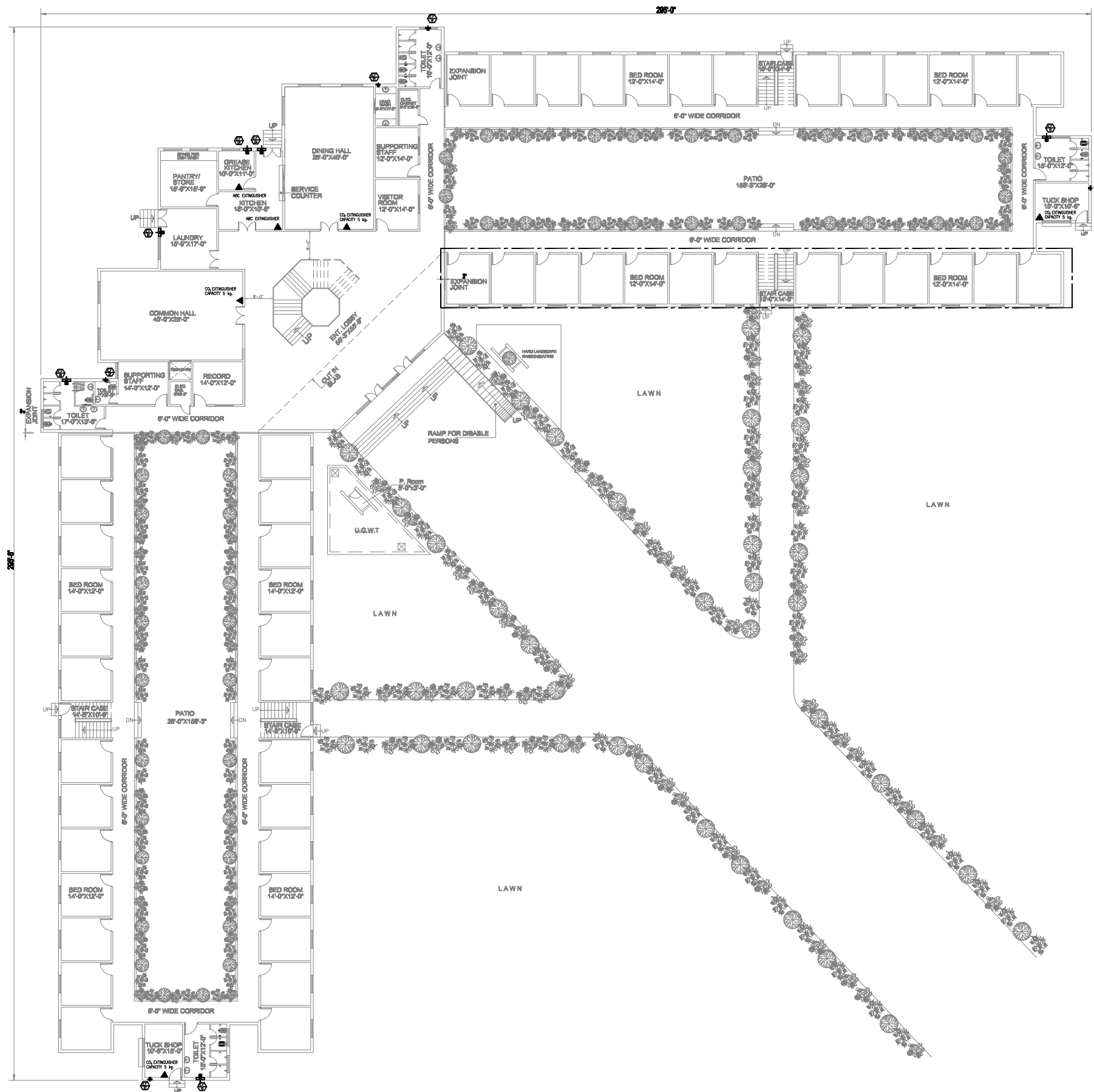

- GENERAL NOTES:
- DO NOT SCALE THE DRAWINGS. THE LOCATIONS OF ALL ITEMS ARE APPROXIMATE ONLY. THE EXACT LOCATIONS NECESSARY TO SECURE THE BEST CONDITIONS AND RESULTS WILL BE DETERMINED BY THE SITE CONDITIONS
 - FLOOR PLANS SHALL BE READ IN CONJUNCTION WITH SCHEMATICS
 - VERIFY STRUCTURAL INTEGRITY OF ALL TEMPORARY AND PERMANENT OPENINGS. ADDITIONAL FRAMING TO ENSURE STRUCTURE INTEGRITY SHALL BE INCLUDED UNDER THIS CONTRACT
 - REFER TO STANDARD DETAILS FOR ADDITIONAL INFORMATION
 - SCHEMATICS SHALL BE READ IN CONJUNCTION WITH FLOOR PLANS.
 - CONTRACTOR SHALL VERIFY AND ENSURE ALL PIPING FITTINGS AND COMPONENTS ARE SUITABLE AS PER SITE CONDITIONS
 - IT IS THE CONTRACTOR RESPONSIBILITY TO ENSURE ALL COMPONENTS ARE LOCATED AND DESIGNED TO WITHSTAND ALL STATIC AND DYNAMIC LOADING.

- HVAC & FIRE NOTES:
- ALL CONDENSATE PIPING TO DRAIN SHALL BE MINIMUM OF 3/4 INCHES AND MAIN CONDENSATE SHALL BE 1 INCH UNLESS INDICATED
 - VERIFY STRUCTURAL INTEGRITY OF ALL TEMPORARY AND PERMANENT OPENINGS. ADDITIONAL FRAMING TO ENSURE STRUCTURE INTEGRITY SHALL BE INCLUDED UNDER THIS CONTRACT
 - ALL REFRIGERANT PIPING SHALL BE AS PER MANUFACTURER RECOMMENDATION WITH PROPER INSULATION
 - ALL PIPING SHALL BE OVERHEAD, TIGHTENED TO UNDERSIDE OF THE STRUCTURE OF ROOM
 - CONTRACTOR MUST ENSURE THE PLACEMENT OF CONDENSING UNIT AS PER STANDARD RECOMMENDATION TO AVOID AIR CHOKING
 - INDOOR UNIT PLACEMENT IS AS PER FURNITURE LAYOUT. FINAL PLACEMENT SHALL BE ON ARCHITECT OR THE OWNER
 - FIRE EXTINGUISHER SHALL COMPLY NFPA 101 COMPLIANCE
 - THE PLACEMENT SHALL BE DONE AS PER SITE CONDITIONS AND ACCORDANCE WITH NFPA 101 STANDARD

ABBREVIATIONS

- A.F.F. ABOVE FINISHED FLOOR
- F.G.L. FINISH GROUND LEVEL
- AC SPLIT UNIT
- CU CONDENSING UNIT

LEGEND

- COND. PIPE
- REF. SUCTION
- REF. LIQUID
- INDOOR UNIT
- CONDENSING UNIT
- EXHAUST FAN

FANS SCHEDULE

S.NO.	SYMBOLS	SERVICE	TYPE	FLOW (CFM)	MOTOR KW	MOTOR R.P.M.	ELECTRICAL CHARACTERISTICS	REMARKS
1	EF-01	EXHAUST FAN	WALL MOUNTED	500	0.5	1750	220V/3PH/50HZ	SASA OR APPROVED MANUFACTURER
2	EF-02	EXHAUST FAN	WALL MOUNTED	100	0.185	1750	220V/3PH/50HZ	SASA OR APPROVED MANUFACTURER
3	EF-03	EXHAUST FAN	WALL MOUNTED	450	0.5	1750	220V/3PH/50HZ	SASA OR APPROVED MANUFACTURER
4	EF-04	EXHAUST FAN	WALL MOUNTED	400	0.5	1750	220V/3PH/50HZ	SASA OR APPROVED MANUFACTURER
5	EF-05	EXHAUST FAN	WALL MOUNTED	300	0.185	1750	220V/3PH/50HZ	SASA OR APPROVED MANUFACTURER
6	EF-06	EXHAUST FAN	WALL MOUNTED	500	0.185	1750	220V/3PH/50HZ	SASA OR APPROVED MANUFACTURER
7	EF-07	EXHAUST FAN	WALL MOUNTED	250	0.185	1750	220V/3PH/50HZ	SASA OR APPROVED MANUFACTURER

2nd Revision : _____ Date : _____
 1st Revision : _____ Date : _____
 1st Revision : _____ Date : _____
 ISSUED FOR TENDER DRAWING Date : 22-11-2021

CLIENT: LIAQUAT UNIVERSITY OF MEDICAL & HEALTH SCIENCES, JAMSHORO, SINDH PAKISTAN JOB TITLE: HOSTEL FOR MALE POAR GRADUATE ARUDENTS	DESCRIPTION: FLOOR LAYOUT FOR GROUND FLOOR JOB NO: 222 DWG. NO.: 322A-002 DRAWN BY: SSW CHECKED BY: SPK SCALE: 1"=30'-0" DATE: 05-08-2021
--	--

YOUNG ASSOCIATES
 CONSULTING ENGINEERS & ARCHITECTS
 8-C 24 9 Commercial Aftab, Phase 2 (Edna),
 Defense Housing Authority, Karachi-75000
 Tel :321-3889444, 321-3891294
 FAX: 321-3889188
 E-mail: info@youngassociates.com.pk

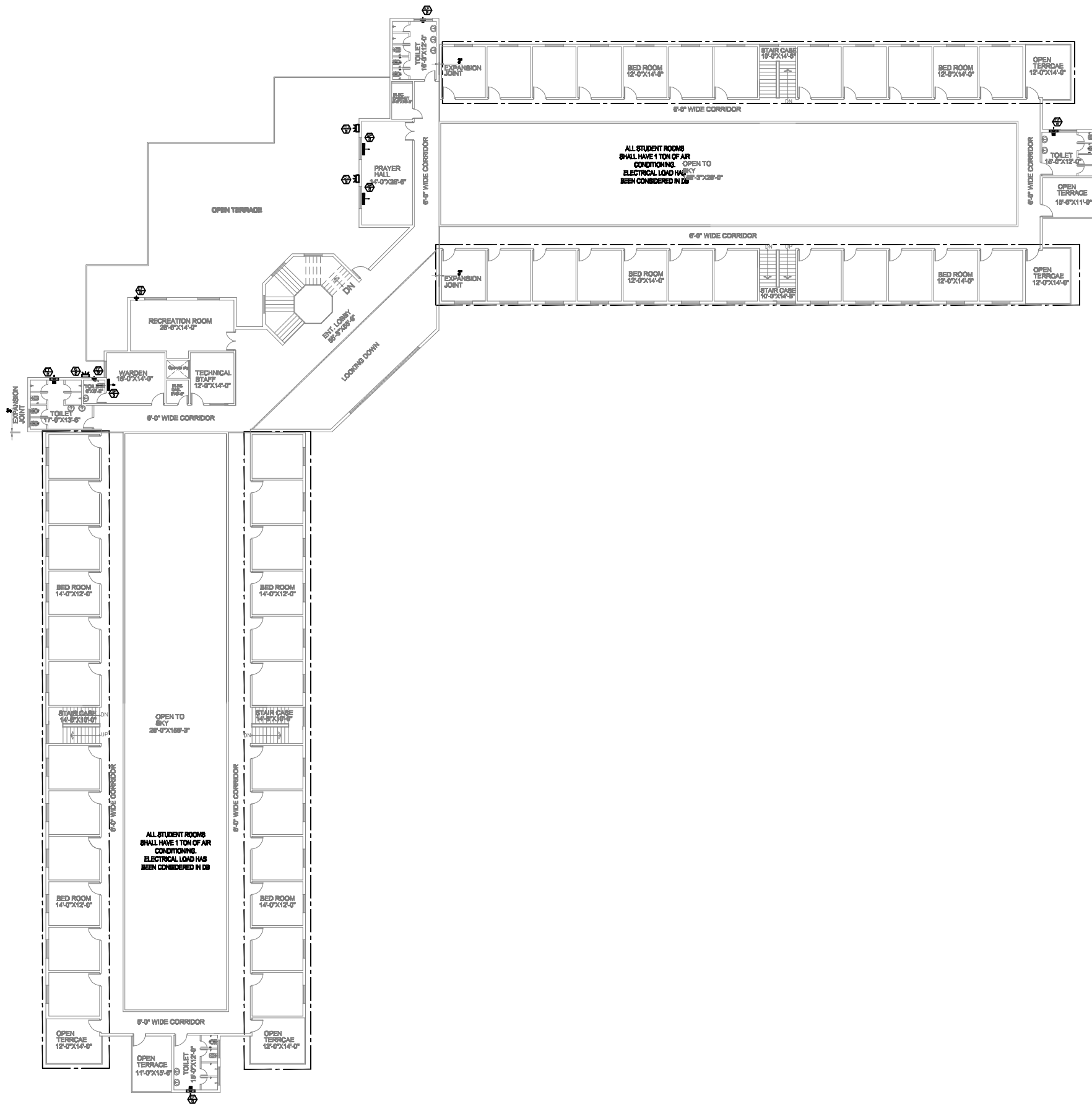

- GENERAL NOTES:**
- DO NOT SCALE THE DRAWINGS. THE LOCATIONS OF ALL ITEMS ARE APPROXIMATE ONLY. THE EXACT LOCATIONS NECESSARY TO SECURE THE BEST CONDITIONS AND RESULTS WILL BE DETERMINED BY THE SITE CONDITIONS
 - FLOOR PLANS SHALL BE READ IN CONJUNCTION WITH SCHEMATICS
 - VERIFY STRUCTURAL INTEGRITY OF ALL TEMPORARY AND PERMANENT OPENINGS. ADDITIONAL FRAMING TO ENSURE STRUCTURE INTEGRITY SHALL BE INCLUDED UNDER THIS CONTRACT
 - REFER TO STANDARD DETAILS FOR ADDITIONAL INFORMATION
 - SCHEMATICS SHALL BE READ IN CONJUNCTION WITH FLOOR PLANS.
 - CONTRACTOR SHALL VERIFY AND ENSURE ALL PIPING FITTINGS AND COMPONENTS ARE SUITABLE AS PER SITE CONDITIONS
 - IT IS THE CONTRACTOR RESPONSIBILITY TO ENSURE ALL COMPONENTS ARE LOCATED AND DESIGNED TO WITHSTAND ALL STATIC AND DYNAMIC LOADING.

- HVAC & FIRE NOTES:**
- ALL CONDENSATE PIPING TO DRAIN SHALL BE MINIMUM OF 3/4 INCHES AND MAIN CONDENSATE SHALL BE 1 INCH UNLESS INDICATED
 - VERIFY STRUCTURAL INTEGRITY OF ALL TEMPORARY AND PERMANENT OPENINGS. ADDITIONAL FRAMING TO ENSURE STRUCTURE INTEGRITY SHALL BE INCLUDED UNDER THIS CONTRACT
 - ALL REFRIGERANT PIPING SHALL BE AS PER MANUFACTURER RECOMMENDATION WITH PROPER INSULATION
 - ALL PIPING SHALL BE OVERHEAD, TIGHTENED TO UNDERSIDE OF THE STRUCTURE OF ROOM
 - CONTRACTOR MUST ENSURE THE PLACEMENT OF CONDENSING UNIT AS PER STANDARD RECOMMENDATION TO AVOID AIR CHOKING
 - INDOOR UNIT PLACEMENT IS AS PER FURNITURE LAYOUT. FINAL PLACEMENT SHALL BE ON ARCHITECT OR THE OWNER
 - FIRE EXTINGUISHER SHALL COMPLY NFPA 101 COMPLIANCE
 - THE PLACEMENT SHALL BE DONE AS PER SITE CONDITIONS AND ACCORDANCE WITH NFPA 101 STANDARD

ABBREVIATIONS

- A.F.F. ABOVE FINISHED FLOOR
- F.G.L. FINISH GROUND LEVEL
- AC SPLIT UNIT
- CU CONDENSING UNIT

LEGEND

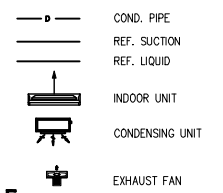

FANS SCHEDULE

S.NO.	SYMBOLS	SERVICE	TYPE	FLOW (CFM)	MOTOR KW	MOTOR R.P.M.	ELECTRICAL CHARACTERISTICS	REMARKS
1	EF-01	EXHAUST FAN	WALL MOUNTED	500	0.5	1750	220V/3PH/50HZ	SASA OR APPROVED MANUFACTURER
2	EF-02	EXHAUST FAN	WALL MOUNTED	100	0.185	1750	220V/3PH/50HZ	SASA OR APPROVED MANUFACTURER

SPLIT AC SCHEDULE

SPLIT TYPE AIR CONDITIONER SCHEDULE

SKID	TAU #	TYPE	CAPACITY (TONS)	CONDENSING COIL DBT / MBT	LEAVING COIL DBT	DESIGN AMBIENT DBT (DEG)	POWER (KW)	POWER SUPPLY (V/PH/Hz)	REMARKS
1	SP-1	WALL MOUNTED	1.0	95.7 / 75	96.12 / 55.0	105	1.65	220 / 50 / 1	ONE OR APPROVED

NOTE: SPLIT AC WITH MINIMUM OF 11.5 EER IS RECOMMENDED

2nd Revision : _____ Date : _____
 1st Revision : _____ Date : _____
 1st Revision : _____ Date : _____
 ISSUED FOR TENDER DRAWING Date : 22-11-2021

CLIENT: LIAQUAT UNIVERSITY OF MEDICAL & HEALTH SCIENCES, JAMSHORO, SINDH PAKISTAN JOB TITLE: HOSTEL FOR MALE POST GRADUATE STUDENTS	DESCRIPTION: HVAC LAYOUT FOR FIRST FLOOR JOB NO: 222 DRG. NO.: 322A-003 DRAWN BY: SSW CHECKED BY: SPK SCALE: 1"=30'-0" DATE: 05-08-2021
--	--

YOUNG ASSOCIATES
 CONSULTING ENGINEERS & ARCHITECTS
 8-C 24 9 Commercial Afters, Phase 2 (Edna),
 Defense Housing Authority, Karachi-75000
 Tel: 321-3689444, 321-3691294
 FAX: 321-36893108
 E-mail: info@youngassociates.com.pk

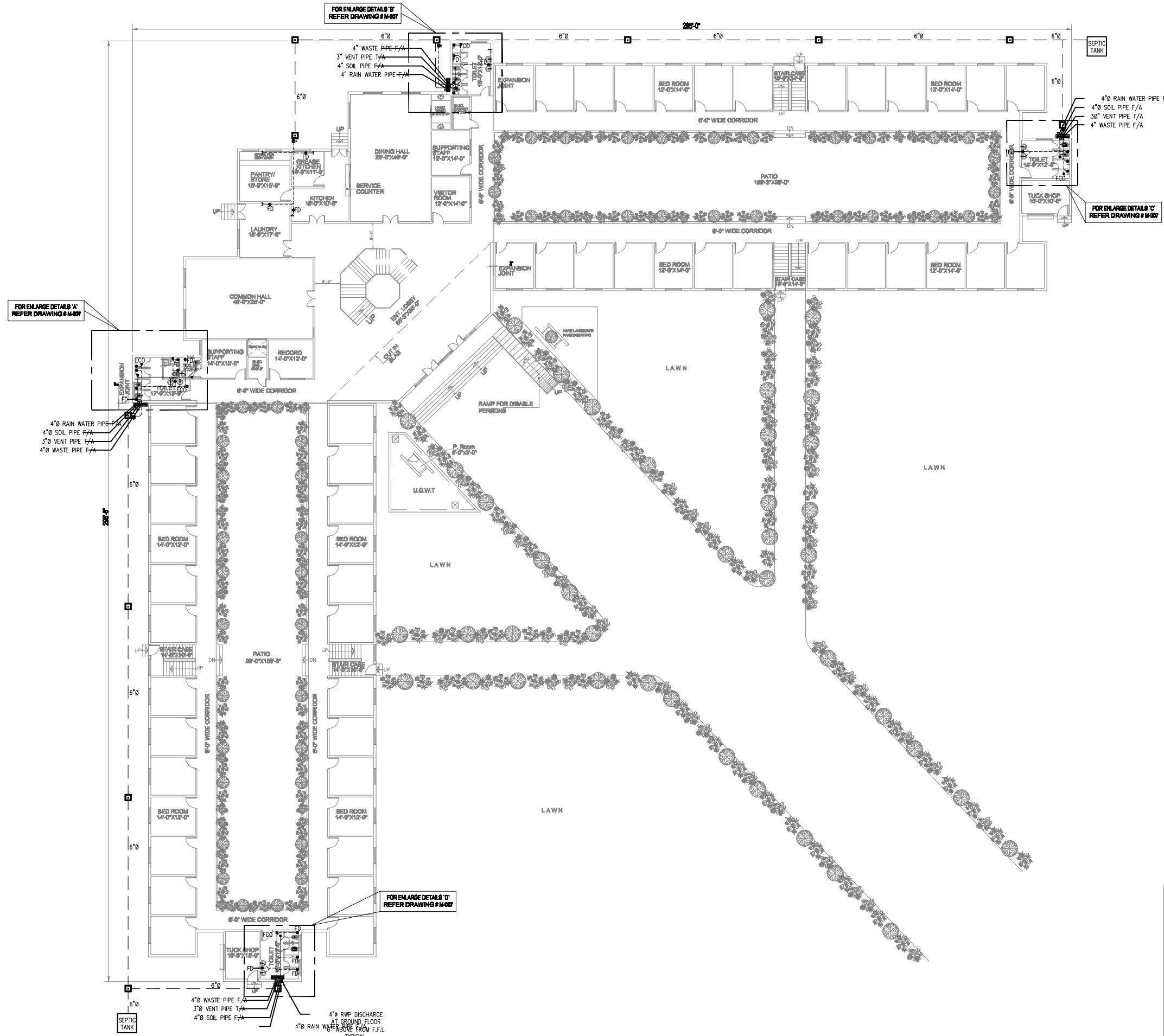

- GENERAL NOTES:
- DO NOT SCALE THE DRAWINGS. THE LOCATIONS OF ALL ITEMS ARE APPROXIMATE ONLY. THE EXACT LOCATIONS NECESSARY TO SECURE THE BEST CONDITIONS AND RESULTS WILL BE DETERMINED BY THE SITE CONDITIONS
 - FLOOR PLANS SHALL BE READ IN CONJUNCTION WITH SCHEMATICS
 - VERIFY STRUCTURAL INTEGRITY OF ALL TEMPORARY AND PERMANENT OPENINGS. ADDITIONAL FRAMING TO ENSURE STRUCTURE INTEGRITY SHALL BE INCLUDED UNDER THIS CONTRACT
 - REFER TO STANDARD DETAILS FOR ADDITIONAL INFORMATION
 - SCHEMATICS SHALL BE READ IN CONJUNCTION WITH FLOOR PLANS.
 - CONTRACTOR SHALL VERIFY AND ENSURE ALL PIPING FITTINGS AND COMPONENTS ARE SUITABLE AS PER SITE CONDITIONS
 - IT IS THE CONTRACTOR RESPONSIBILITY TO ENSURE ALL COMPONENTS ARE LOCATED AND DESIGNED TO WITHSTAND ALL STATIC AND DYNAMIC LOADING.

- DRAINAGE NOTES:
- ALL SANITARY BELOW GRADE IS MINIMUM 3 / 4 INCHES UNLESS OTHERWISE
 - ALL FLOOR DRAINS SHALL BE COMPLETE WITH TRAPS AND TRAP PRIMERS
 - ALL STORM DRAINAGE SHALL BE MINIMUM OF 4 INCHES BELOW GRADE UNLESS OTHERWISE INDICATED
 - ALL PIPING SHALL BE OVERHEAD, TIGHTENED TO UNDERSIDE OF THE STRUCTURE OF ROOM
 - INVERT LEVEL SHALL BE VERIFY BY CONTRACTOR AT SITE PRIOR TO EXECUTION

ABBREVIATIONS

FD	FLOOR DRAIN
RWP	RAIN WATER PIPE
SS	SOIL STACK
WS	WASTE STACK
RWS	RAIN WATER STACK
VP	VENT PIPE
COP	CLEAN OUT PLUG
F/A	FROM ABOVE
T/B	TO BELOW
T/A	TO ABOVE
F/B	FROM BELOW
LL	INVERT LEVEL
WH	WINDHOLE

LEGEND

---	WASTE PIPE
---	SOIL PIPE
---	VENT PIPE
---	BANKED PIPE
---	CLEAN OUT PLUG
---	FLOOR CLEAN OUT
---	VENT COIL (ROOF TYPE)
FD	FLOOR DRAIN
CT	GALLEY TRAP
WH	WINDHOLE

2nd Revision : _____	Date : _____
1st Revision : _____	Date : _____
ISSUED FOR : TENDER DRAWING	Date : 22-12-2021
CLIENT: LIAQUAT UNIVERSITY OF MEDICAL & HEALTH SCIENCES, JAMSHORO, SINDH PAKISTAN	DESCRIPTION: DRAINAGE LAYOUT FOR GROUND FLOOR
JOB TITLE: HOSTEL FOR MALE POST GRADUATE STUDENTS	JOB NO: 222
YOUNG ASSOCIATES CONSULTING ENGINEERS & ARCHITECTS 8-C 24 9 Commercial Aftab, Phase 2 (Edna), Defense Housing Authority, Karachi-75200 Tel: 321-3889444, 321-3891294 FAX: 321-3889188 E-mail: info@youngassociates.com.pk	DRG. NO.: 322M-004
	DRAWN BY: SSW
	CHECKED BY: SPK
	SCALE: 1"=30'-0" DATE: 05-08-2021

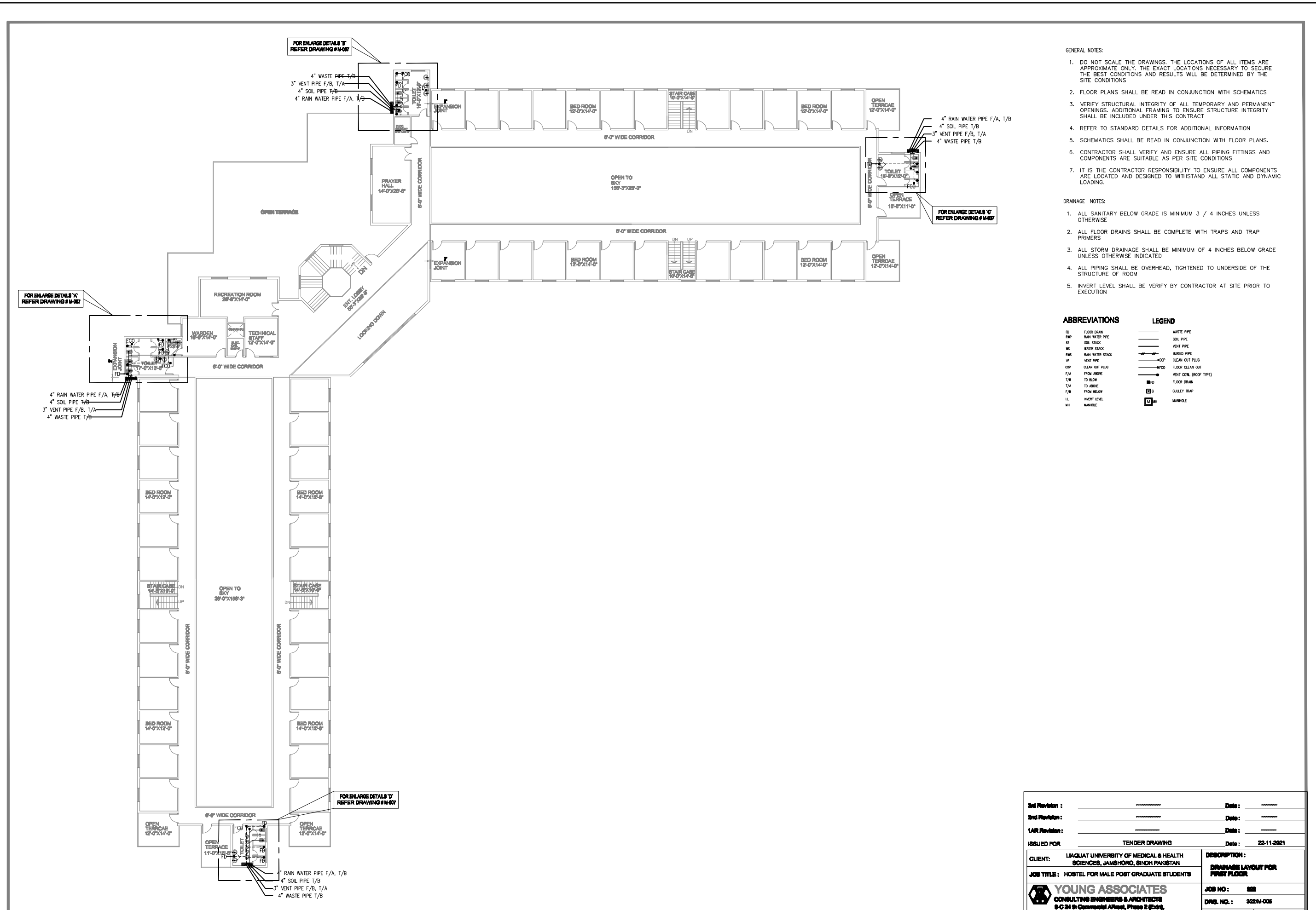

- GENERAL NOTES:
- DO NOT SCALE THE DRAWINGS. THE LOCATIONS OF ALL ITEMS ARE APPROXIMATE ONLY. THE EXACT LOCATIONS NECESSARY TO SECURE THE BEST CONDITIONS AND RESULTS WILL BE DETERMINED BY THE SITE CONDITIONS
 - FLOOR PLANS SHALL BE READ IN CONJUNCTION WITH SCHEMATICS
 - VERIFY STRUCTURAL INTEGRITY OF ALL TEMPORARY AND PERMANENT OPENINGS. ADDITIONAL FRAMING TO ENSURE STRUCTURE INTEGRITY SHALL BE INCLUDED UNDER THIS CONTRACT
 - REFER TO STANDARD DETAILS FOR ADDITIONAL INFORMATION
 - SCHEMATICS SHALL BE READ IN CONJUNCTION WITH FLOOR PLANS.
 - CONTRACTOR SHALL VERIFY AND ENSURE ALL PIPING FITTINGS AND COMPONENTS ARE SUITABLE AS PER SITE CONDITIONS
 - IT IS THE CONTRACTOR RESPONSIBILITY TO ENSURE ALL COMPONENTS ARE LOCATED AND DESIGNED TO WITHSTAND ALL STATIC AND DYNAMIC LOADING.

- DRAINAGE NOTES:
- ALL SANITARY BELOW GRADE IS MINIMUM 3 / 4 INCHES UNLESS OTHERWISE
 - ALL FLOOR DRAINS SHALL BE COMPLETE WITH TRAPS AND TRAP PRIMERS
 - ALL STORM DRAINAGE SHALL BE MINIMUM OF 4 INCHES BELOW GRADE UNLESS OTHERWISE INDICATED
 - ALL PIPING SHALL BE OVERHEAD, TIGHTENED TO UNDERSIDE OF THE STRUCTURE OF ROOM
 - INVERT LEVEL SHALL BE VERIFY BY CONTRACTOR AT SITE PRIOR TO EXECUTION

ABBREVIATIONS

- FD FLOOR DRAIN
- RWP RAIN WATER PIPE
- SS SOIL STACK
- WS WASTE STACK
- RWS RAIN WATER STACK
- VP VENT PIPE
- COP CLEAN OUT PLUG
- F/A FROM ABOVE
- T/B TO BLOW
- T/A TO ABOVE
- F/B FROM BELOW
- IL INVERT LEVEL
- WH MANHOLE

LEGEND

- WASTE PIPE
- SOIL PIPE
- VENT PIPE
- BURNED PIPE
- CLEAN OUT PLUG
- FLOOR CLEAN OUT
- VENT COIL (ROOF TYPE)
- FLOOR DRAIN
- GALLEY TRAP
- MANHOLE

2nd Revision : _____	Date : _____
1st Revision : _____	Date : _____
ISSUED FOR TENDER DRAWING	Date : 22-11-2021
CLIENT: LIAQUAT UNIVERSITY OF MEDICAL & HEALTH SCIENCES, JAMSHORO, SINDH PAKISTAN	DESCRIPTION: DRAINAGE LAYOUT FOR FIRST FLOOR
JOB TITLE: HOSTEL FOR MALE POST GRADUATE STUDENTS	JOB NO: 222
YOUNG ASSOCIATES CONSULTING ENGINEERS & ARCHITECTS 8-C 24 9 Commercial Aftab, Phase 2 (Edna), Defense Housing Authority, Karachi-75000 Tel: 321-3229444, 321-3221234 PASC: 221-2222123 E-mail: info@youngassociates.com.pk	DWG. NO.: 322M-005
	DRAWN BY: SSW
	CHECKED BY: SPK
SCALE: 1"=30'-0"	DATE: 05-08-2021

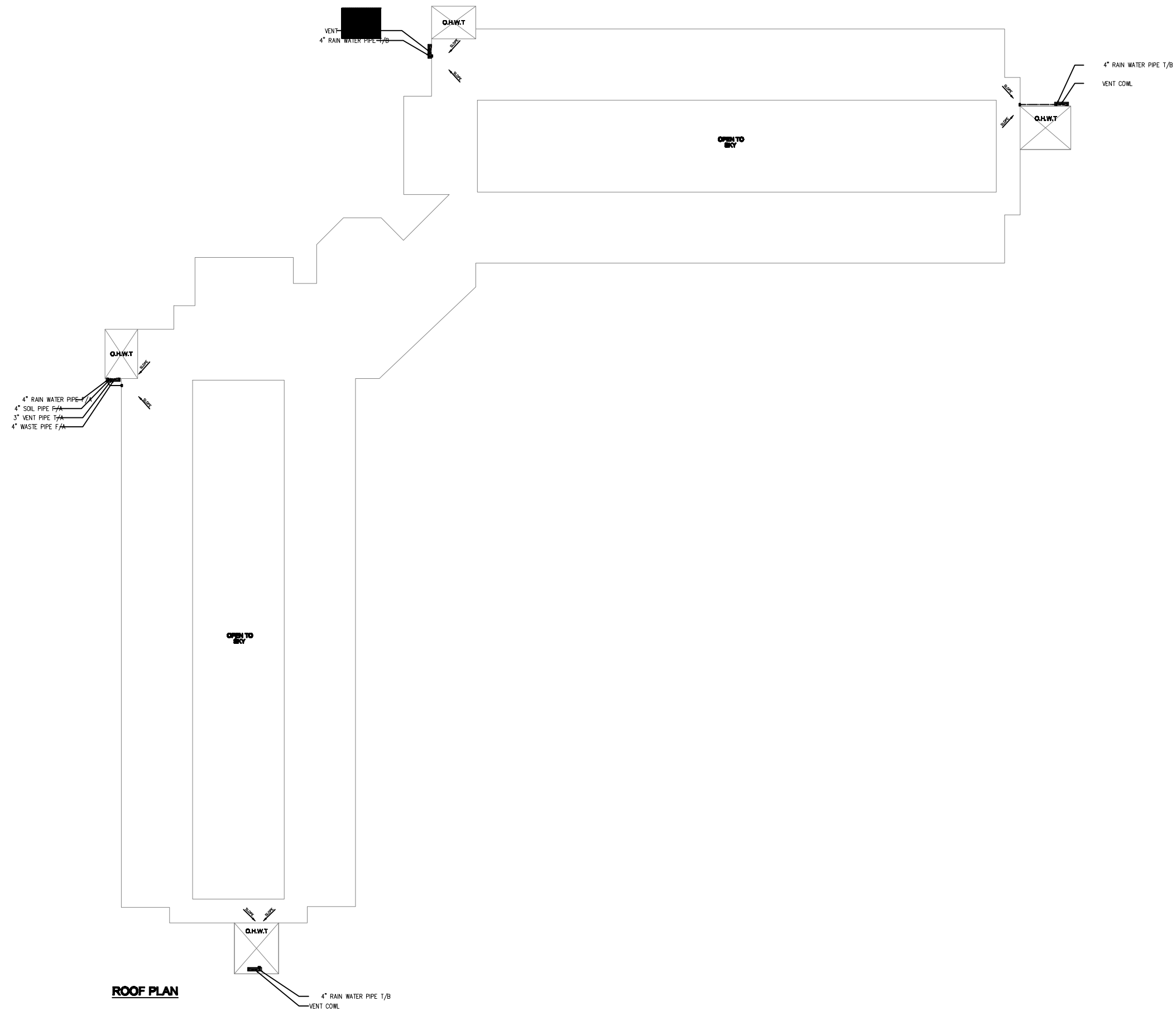

- GENERAL NOTES:**
- DO NOT SCALE THE DRAWINGS. THE LOCATIONS OF ALL ITEMS ARE APPROXIMATE ONLY. THE EXACT LOCATIONS NECESSARY TO SECURE THE BEST CONDITIONS AND RESULTS WILL BE DETERMINED BY THE SITE CONDITIONS
 - FLOOR PLANS SHALL BE READ IN CONJUNCTION WITH SCHEMATICS
 - VERIFY STRUCTURAL INTEGRITY OF ALL TEMPORARY AND PERMANENT OPENINGS. ADDITIONAL FRAMING TO ENSURE STRUCTURE INTEGRITY SHALL BE INCLUDED UNDER THIS CONTRACT
 - REFER TO STANDARD DETAILS FOR ADDITIONAL INFORMATION
 - SCHEMATICS SHALL BE READ IN CONJUNCTION WITH FLOOR PLANS.
 - CONTRACTOR SHALL VERIFY AND ENSURE ALL PIPING FITTINGS AND COMPONENTS ARE SUITABLE AS PER SITE CONDITIONS
 - IT IS THE CONTRACTOR RESPONSIBILITY TO ENSURE ALL COMPONENTS ARE LOCATED AND DESIGNED TO WITHSTAND ALL STATIC AND DYNAMIC LOADING.

- DRAINAGE NOTES:**
- ALL SANITARY BELOW GRADE IS MINIMUM 3 / 4 INCHES UNLESS OTHERWISE
 - ALL FLOOR DRAINS SHALL BE COMPLETE WITH TRAPS AND TRAP PRIMERS
 - ALL STORM DRAINAGE SHALL BE MINIMUM OF 4 INCHES BELOW GRADE UNLESS OTHERWISE INDICATED
 - ALL PIPING SHALL BE OVERHEAD, TIGHTENED TO UNDERSIDE OF THE STRUCTURE OF ROOM
 - INVERT LEVEL SHALL BE VERIFY BY CONTRACTOR AT SITE PRIOR TO EXECUTION

ABBREVIATIONS	LEGEND		
RD	RAIN DOWN	—	WASTE PIPE
RUP	RAIN WATER PIPE	—	SOIL PIPE
RS	RAIN WATER PIPE	—	VENT PIPE
WS	WASTE STACK	—	SOIL PIPE
RWS	RAIN WATER STACK	—	WASTE PIPE
VP	VENT PIPE	—	CLEAN OUT FLUG
CFP	CLEAN OUT FLUG	—	FLOOR CLEAN OUT
F/A	FLOOR ABOVE	—	VENT COWL (ROOF TYPE)
T/B	TO BELOW	—	FLOOR DRAIN
T/A	TO ABOVE	—	GALLEY TRAP
F/A	FLOOR ABOVE	—	WASTEWATER
IL	INVERT LEVEL	—	
W	WASTEWATER	—	

ROOF PLAN

2nd Revision : _____	Date : _____
1st Revision : _____	Date : _____
ISSUED FOR : TENDER DRAWING	Date : 22-11-2021
CLIENT: LIAQUAT UNIVERSITY OF MEDICAL & HEALTH SCIENCES, JAMSHORO, SINDH PAKISTAN	DESCRIPTION: DRAINAGE LAYOUT FOR GROUND FLOOR
JOB TITLE: HOSTEL FOR MALE POST GRADUATE STUDENTS	JOB NO: 222
 YOUNG ASSOCIATES CONSULTING ENGINEERS & ARCHITECTS 8-C 24 9 Commercial Aftab, Phase 2 (Edna), Defense Housing Authority, Karachi-75000 Tel: 321-3222444, 321-3221234 PASC: 221-3222444 E-mail: info@youngassociates.com.pk	DRAW. NO.: 322A-008 DRAWN BY: SSW CHECKED BY: SPK SCALE: 1"=30'-0" DATE: 05-08-2021

- GENERAL NOTES:
- DO NOT SCALE THE DRAWINGS. THE LOCATIONS OF ALL ITEMS ARE APPROXIMATE ONLY. THE EXACT LOCATIONS NECESSARY TO SECURE THE BEST CONDITIONS AND RESULTS WILL BE DETERMINED BY THE SITE CONDITIONS.
 - FLOOR PLANS SHALL BE READ IN CONJUNCTION WITH SCHEMATICS.
 - VERIFY STRUCTURAL INTEGRITY OF ALL TEMPORARY AND PERMANENT OPENINGS. ADDITIONAL FRAMING TO ENSURE STRUCTURE INTEGRITY SHALL BE INCLUDED UNDER THIS CONTRACT.
 - REFER TO STANDARD DETAILS FOR ADDITIONAL INFORMATION.
 - SCHEMATICS SHALL BE READ IN CONJUNCTION WITH FLOOR PLANS.
 - CONTRACTOR SHALL VERIFY AND ENSURE ALL PIPING FITTINGS AND COMPONENTS ARE SUITABLE AS PER SITE CONDITIONS.
 - IT IS THE CONTRACTOR RESPONSIBILITY TO ENSURE ALL COMPONENTS ARE LOCATED AND DESIGNED TO WITHSTAND ALL STATIC AND DYNAMIC LOADING.

- WATER SUPPLY NOTES:
- ALL DOMESTIC COLD AND HOT WATER LINES SHALL BE MINIMUM 3/4 INCHES UNLESS OTHERWISE INDICATED.
 - VERIFY STRUCTURAL INTEGRITY OF ALL TEMPORARY AND PERMANENT OPENINGS. ADDITIONAL FRAMING TO ENSURE STRUCTURE INTEGRITY SHALL BE INCLUDED UNDER THIS CONTRACT.
 - REFER TO PLUMBING STANDARD DETAILS FOR ADDITIONAL INFORMATION.
 - ALL PIPING SHALL BE OVERHEAD, TIGHTENED TO UNDERSIDE OF THE STRUCTURE OF ROOM.

LEGEND

—	INCOMING CITY WATER	FD	FLOOR DRAIN
—	COLD WATER MAIN SUPPLY	RWP	RAIN WATER PIPE
—	COLD WATER SUPPLY	SS	SOIL STACK
—	HOT WATER SUPPLY	WS	WASTE STACK
—	BURIED COLD WATER SUPPLY	RWS	RAIN WATER STACK
—	MUSLIM SHOWER	VP	VENT PIPE
—	FLOOR VALVE	CP	CLEAN OUT PLUG
—	GATE VALVE	T/A	TO ABOVE
—	CHECK VALVE	T/B	TO BELOW
—	BALL VALVE	T/A	TO ABOVE
—	SOLENOID VALVE	T/B	TO BELOW
—	GAS HOT WATER	LL	LOW LEVEL
—		MI	MANHOLE

TRANSFER PUMP SCHEDULE

S.NO.	SYMBOLS	QTY.	SERVICE	TYPE	FLOW (CFM)	NET DISCHARGE HEAD (FT)	MOTOR KW	MOTOR R.P.M.	ELECTRICAL CHARACTERISTICS	REMARKS
1		1	TRANSFER OVERHEAD PUMP	CENTRIFUGAL PUMP	250	115	3.73	1750	220V/1PH/50HZ	LOCATED AT GROUND FLOOR

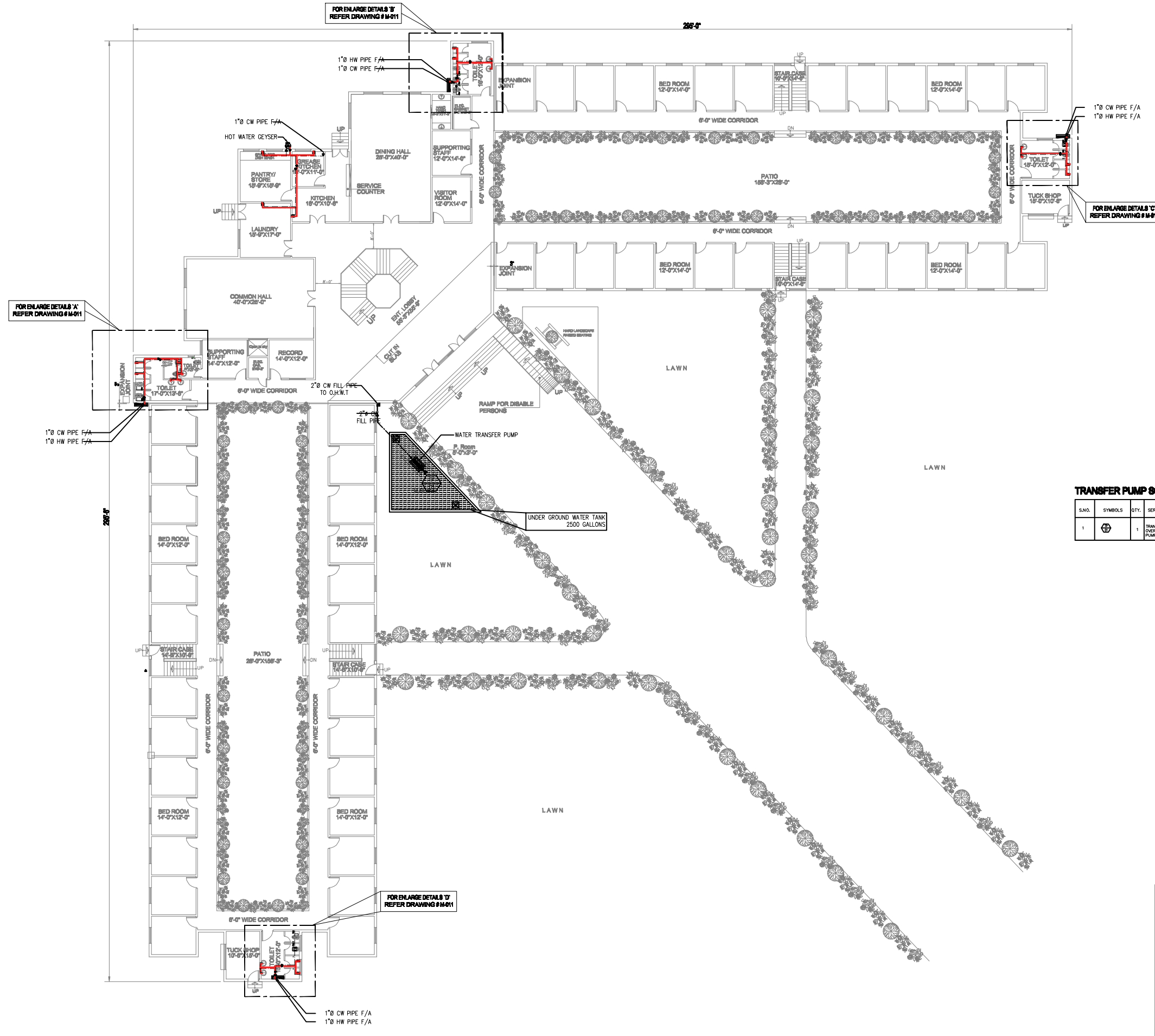

2nd Revision : _____	Date : _____
1st Revision : _____	Date : _____
ISSUED FOR : TENDER DRAWING	Date : 00-10-2021
CLIENT: LIAQUAT UNIVERSITY OF MEDICAL & HEALTH SCIENCES, JAMSHORO, SINDH PAKISTAN	DESCRIPTION: WATER SUPPLY LAYOUT FOR GROUND FLOOR
JOB TITLE: HOSTEL FOR MALE POST GRADUATE STUDENTS	JOB NO: 222
YOUNG ASSOCIATES CONSULTING ENGINEERS & ARCHITECTS 8-C 24 St Commercial Aftab, Phase 2 (Edna), Defense Housing Authority, Karachi-75000 Tel: 321-3222444, 321-3221234 FAX: 321-3222123 E-mail: info@youngassociates.com.pk	DWG. NO.: 322AM-008
	DRAWN BY: SSW
	CHECKED BY: SPK
SCALE: 1"=30'-0"	DATE: 05-08-2021

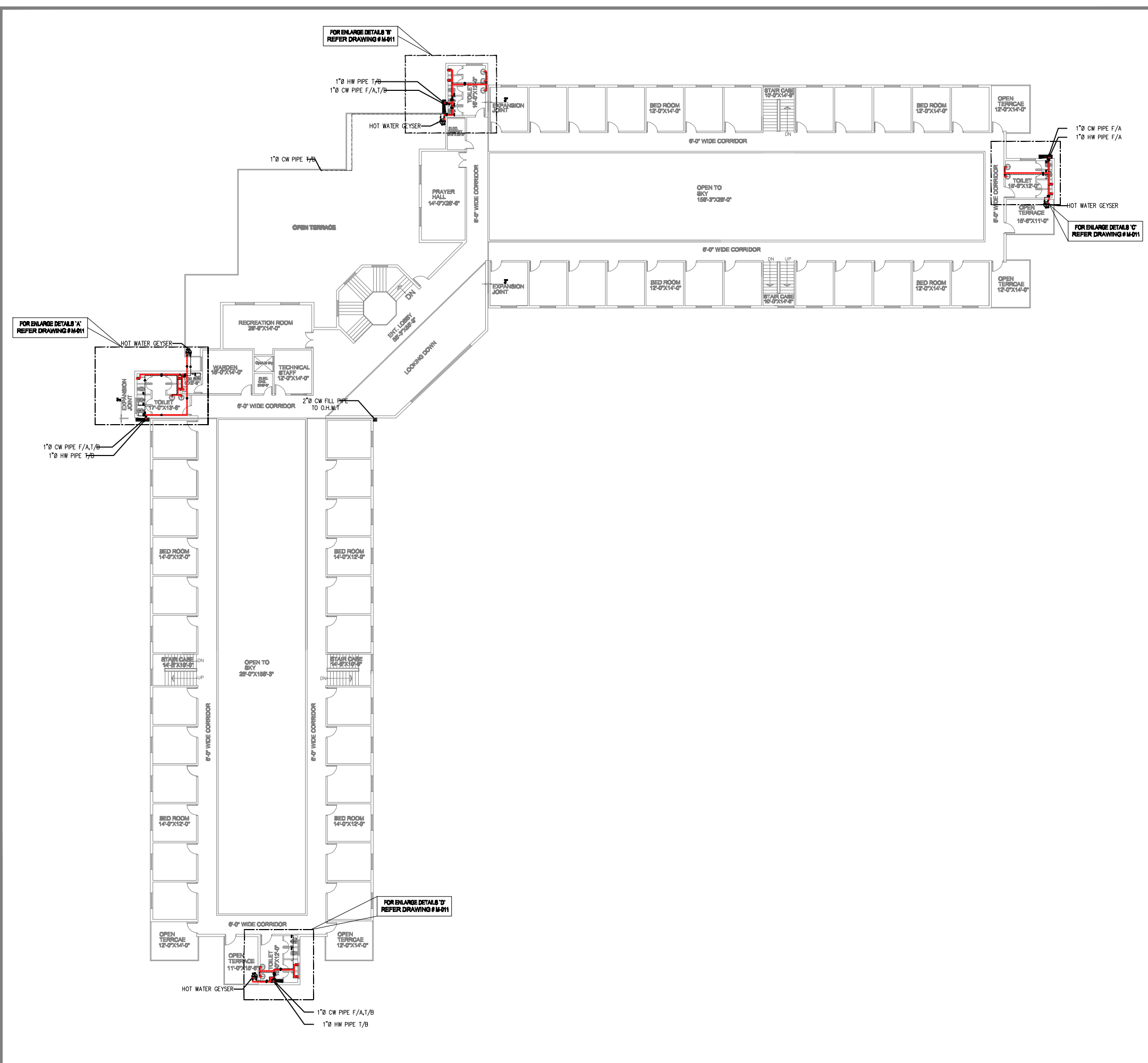

- GENERAL NOTES:
- DO NOT SCALE THE DRAWINGS. THE LOCATIONS OF ALL ITEMS ARE APPROXIMATE ONLY. THE EXACT LOCATIONS NECESSARY TO SECURE THE BEST CONDITIONS AND RESULTS WILL BE DETERMINED BY THE SITE CONDITIONS
 - FLOOR PLANS SHALL BE READ IN CONJUNCTION WITH SCHEMATICS
 - VERIFY STRUCTURAL INTEGRITY OF ALL TEMPORARY AND PERMANENT OPENINGS. ADDITIONAL FRAMING TO ENSURE STRUCTURE INTEGRITY SHALL BE INCLUDED UNDER THIS CONTRACT
 - REFER TO STANDARD DETAILS FOR ADDITIONAL INFORMATION
 - SCHEMATICS SHALL BE READ IN CONJUNCTION WITH FLOOR PLANS.
 - CONTRACTOR SHALL VERIFY AND ENSURE ALL PIPING FITTINGS AND COMPONENTS ARE SUITABLE AS PER SITE CONDITIONS
 - IT IS THE CONTRACTOR RESPONSIBILITY TO ENSURE ALL COMPONENTS ARE LOCATED AND DESIGNED TO WITHSTAND ALL STATIC AND DYNAMIC LOADING.

- WATER SUPPLY NOTES:
- ALL DOMESTIC COLD AND HOT WATER LINES SHALL BE MINIMUM 3/4 INCHES UNLESS OTHERWISE INDICATED
 - VERIFY STRUCTURAL INTEGRITY OF ALL TEMPORARY AND PERMANENT OPENINGS. ADDITIONAL FRAMING TO ENSURE STRUCTURE INTEGRITY SHALL BE INCLUDED UNDER THIS CONTRACT
 - REFER TO PLUMBING STANDARD DETAILS FOR ADDITIONAL INFORMATION
 - ALL PIPING SHALL BE OVERHEAD, TIGHTENED TO UNDERSIDE OF THE STRUCTURE OF ROOM

LEGEND		ABBREVIATIONS	
—	INCOMING CITY WATER	FD	FLOOR DRAIN
—	COLD WATER MAIN SUPPLY	RWP	RAIN WATER PIPE
—	HOT WATER SUPPLY	SS	SOIL STACK
—	BURIED COLD WATER SUPPLY	MS	WASTE STACK
—	MUSLIM SHOWER	RWS	RAIN WATER STACK
—	FLOAT VALVE	VP	VENT PIPE
—	HOSE END (HE)	COP	CLEAN OUT PLUG
—	GATE VALVE	F/A	FROM ABOVE
—	CHECK VALVE	T/B	TO BELOW
—	BALL VALVE	T/A	TO ABOVE
—	SOLVED VALVE	F/B	FROM BELOW
—	GAS HOT WATER	LL	HIGHER LEVEL
		WH	WHAIR

2nd Revision : _____	Date : _____
1st Revision : _____	Date : _____
ISSUED FOR : TENDER DRAWING	Date : 22-11-2021
CLIENT: LIAQUAT UNIVERSITY OF MEDICAL & HEALTH SCIENCES, JAMSHORO, SINDH PAKISTAN	DESCRIPTION: WATER SUPPLY LAYOUT FOR FIRST FLOOR
JOB TITLE: HOSTEL FOR MALE POST GRADUATE STUDENTS	JOB NO: 222
YOUNG ASSOCIATES CONSULTING ENGINEERS & ARCHITECTS 8-C 24 9 Commercial Aftab, Phase 2 (Edna), Defense Housing Authority, Karachi-75000 Tel: 321-3222444, 321-3221234 PASC: 221-2222222 E-mail: info@youngassociates.com.pk	DRG. NO.: 322M-008
	DRAWN BY: SSW
	CHECKED BY: SPK
SCALE: 1"=30'-0"	DATE: 05-08-2021

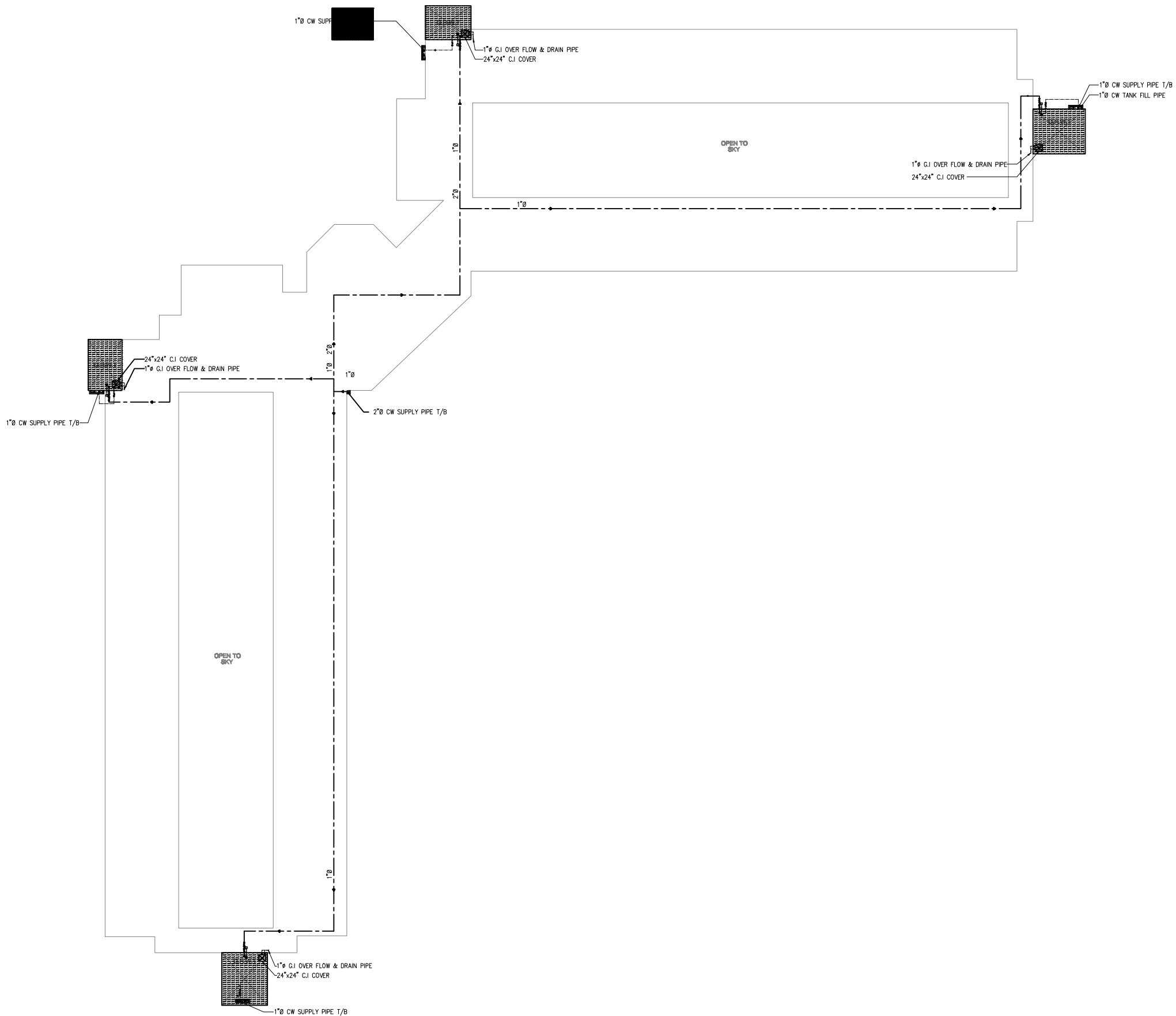

ROOF PLAN

- GENERAL NOTES:**
- DO NOT SCALE THE DRAWINGS. THE LOCATIONS OF ALL ITEMS ARE APPROXIMATE ONLY. THE EXACT LOCATIONS NECESSARY TO SECURE THE BEST CONDITIONS AND RESULTS WILL BE DETERMINED BY THE SITE CONDITIONS
 - FLOOR PLANS SHALL BE READ IN CONJUNCTION WITH SCHEMATICS
 - VERIFY STRUCTURAL INTEGRITY OF ALL TEMPORARY AND PERMANENT OPENINGS. ADDITIONAL FRAMING TO ENSURE STRUCTURE INTEGRITY SHALL BE INCLUDED UNDER THIS CONTRACT
 - REFER TO STANDARD DETAILS FOR ADDITIONAL INFORMATION
 - SCHEMATICS SHALL BE READ IN CONJUNCTION WITH FLOOR PLANS.
 - CONTRACTOR SHALL VERIFY AND ENSURE ALL PIPING FITTINGS AND COMPONENTS ARE SUITABLE AS PER SITE CONDITIONS
 - IT IS THE CONTRACTOR RESPONSIBILITY TO ENSURE ALL COMPONENTS ARE LOCATED AND DESIGNED TO WITHSTAND ALL STATIC AND DYNAMIC LOADING.

- WATER SUPPLY NOTES:**
- ALL DOMESTIC COLD AND HOT WATER LINES SHALL BE MINIMUM 3/4 INCHES UNLESS OTHERWISE INDICATED
 - VERIFY STRUCTURAL INTEGRITY OF ALL TEMPORARY AND PERMANENT OPENINGS. ADDITIONAL FRAMING TO ENSURE STRUCTURE INTEGRITY SHALL BE INCLUDED UNDER THIS CONTRACT
 - REFER TO PLUMBING STANDARD DETAILS FOR ADDITIONAL INFORMATION
 - ALL PIPING SHALL BE OVERHEAD, TIGHTENED TO UNDERSIDE OF THE STRUCTURE OF ROOM

LEGEND		ABBREVIATIONS	
—	INCOMING CITY WATER	FD	FLOOR DRAIN
—	COLD WATER MAIN SUPPLY	SDP	SOIL DRAIN PIPE
—	COLD WATER SUPPLY	SD	SOIL DRAIN
—	HOT WATER SUPPLY	SDP	SOIL DRAIN PIPE
—	BURIED COLD WATER SUPPLY	SD	SOIL DRAIN
—	MURDER SHOWER	SD	SOIL DRAIN
—	FLOOR VALVE	SDP	SOIL DRAIN PIPE
—	HOSE BB (DE)	SD	SOIL DRAIN
—	GATE VALVE	SDP	SOIL DRAIN PIPE
—	CHECK VALVE	SD	SOIL DRAIN
—	BALL VALVE	SDP	SOIL DRAIN PIPE
—	SOLENOID VALVE	SD	SOIL DRAIN
—	GAS HOT WATER	SD	SOIL DRAIN

2nd Revision :	_____	Date :	_____
1st Revision :	_____	Date :	_____
ISSUED FOR	TENDER DRAWING	Date :	22-11-2021
CLIENT:	LIAQUAT UNIVERSITY OF MEDICAL & HEALTH SCIENCES, JAMSHORO, SINDH PAKISTAN	DESCRIPTION:	WATER SUPPLY LAYOUT FOR ROOF
JOB TITLE :	HOSTEL FOR MALE POST GRADUATE STUDENTS	JOB NO :	222
YOUNG ASSOCIATES CONSULTING ENGINEERS & ARCHITECTS 8-C 24 St Commercial Aftab, Phase 2 (Edna), Defense Housing Authority, Karachi-75200 Tel :321-3229444, 321-3221234 FAX :321-3229199 E-mail: info@youngassociates.com.pk		DWG. NO. :	322M-010
		DRAWN BY :	SSW
		CHECKED BY :	SPK
		SCALE :	1"=30'-0"
		DATE :	06-08-2021

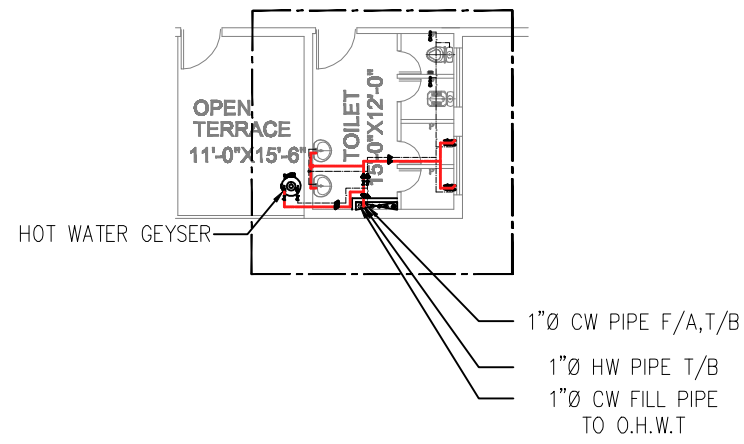

1 PLUMBING ENLARGE DETAILS 'D'
M08/ M-008 1/16"=1'-0"

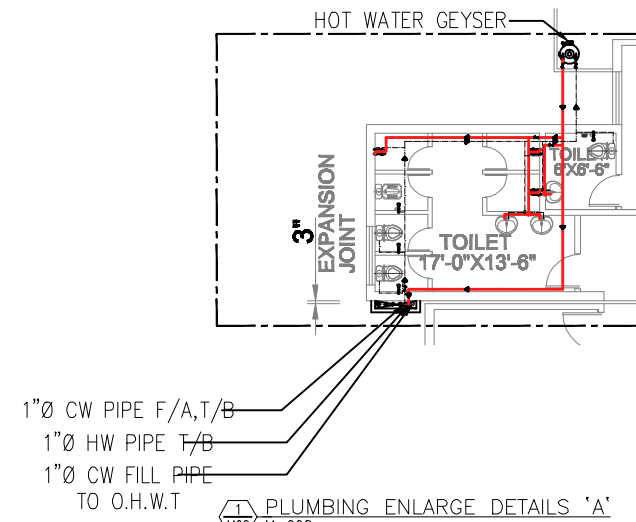

1 PLUMBING ENLARGE DETAILS 'A'
M08/ M-008 1/16"=1'-0"

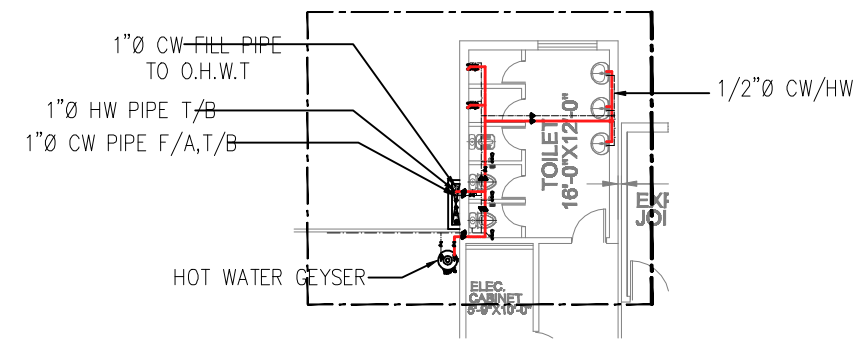

1 PLUMBING ENLARGE DETAILS 'B'
M08/ M-008 1/16"=1'-0"

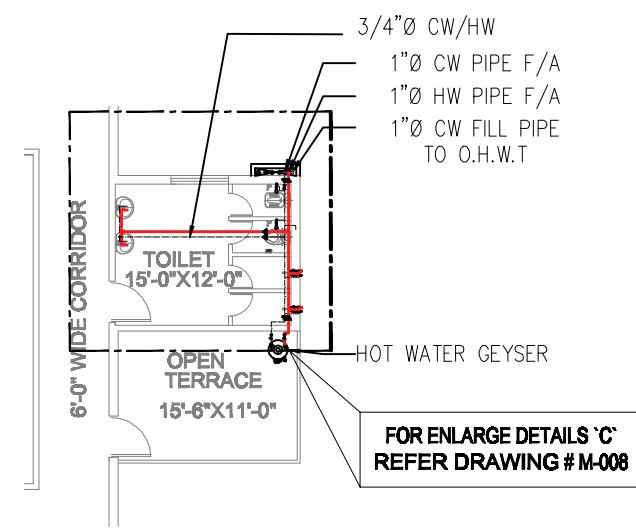

1 PLUMBING ENLARGE DETAILS 'C'
M08/ M-008 1/16"=1'-0"

- GENERAL NOTES:**
- DO NOT SCALE THE DRAWINGS. THE LOCATIONS OF ALL ITEMS ARE APPROXIMATE ONLY. THE EXACT LOCATIONS NECESSARY TO SECURE THE BEST CONDITIONS AND RESULTS WILL BE DETERMINED BY THE SITE CONDITIONS
 - FLOOR PLANS SHALL BE READ IN CONJUNCTION WITH SCHEMATICS
 - VERIFY STRUCTURAL INTEGRITY OF ALL TEMPORARY AND PERMANENT OPENINGS. ADDITIONAL FRAMING TO ENSURE STRUCTURE INTEGRITY SHALL BE INCLUDED UNDER THIS CONTRACT
 - REFER TO STANDARD DETAILS FOR ADDITIONAL INFORMATION
 - SCHEMATICS SHALL BE READ IN CONJUNCTION WITH FLOOR PLANS.
 - CONTRACTOR SHALL VERIFY AND ENSURE ALL PIPING FITTINGS AND COMPONENTS ARE SUITABLE AS PER SITE CONDITIONS
 - IT IS THE CONTRACTOR RESPONSIBILITY TO ENSURE ALL COMPONENTS ARE LOCATED AND DESIGNED TO WITHSTAND ALL STATIC AND DYNAMIC LOADING.

- DRAINAGE NOTES:**
- ALL SANITARY BELOW GRADE IS MINIMUM 3 / 4 INCHES UNLESS OTHERWISE
 - ALL FLOOR DRAINS SHALL BE COMPLETE WITH TRAPS AND TRAP PRIMERS
 - ALL STORM DRAINAGE SHALL BE MINIMUM OF 4 INCHES BELOW GRADE UNLESS OTHERWISE INDICATED
 - ALL PIPING SHALL BE OVERHEAD, TIGHTENED TO UNDERSIDE OF THE STRUCTURE OF ROOM
 - INVERT LEVEL SHALL BE VERIFY BY CONTRACTOR AT SITE PRIOR TO EXECUTION

ABBREVIATIONS	LEGEND		
SD	FLASH DRAIN	—	WASTE PIPE
SDP	SOIL DRAIN PIPE	—	SOIL PIPE
SDS	SOIL STACK	—	VENT PIPE
WS	WASTE STACK	—	WASTE PIPE
SDS	SOIL DRAIN STACK	—	CLEAN OUT FLUG
SD	SOIL PIPE	—	—
SDP	CLEAN OUT PIPE	—	FLOOR CLEAN OUT
F/A	FLOOR AREA	—	VENT COIL (ROOF TYPE)
T/B	TOILET	—	—
T/B	TOILET	—	FLOOR DRAIN
F/A	FLOOR AREA	—	—
IL	INVERT LEVEL	—	—
SH	SHOWER	—	—

2nd Revision : _____	Date : _____
1st Revision : _____	Date : _____
ISSUED FOR : TENDER DRAWING	Date : 22-11-2021
CLIENT: LIAQUAT UNIVERSITY OF MEDICAL & HEALTH SCIENCES, JAMSHORO, SINDH PAKISTAN	DESCRIPTION: DRAINAGE LAYOUT FOR GROUND FLOOR
JOB TITLE: HOSTEL FOR MALE POST GRADUATE STUDENTS	JOB NO: 222
YOUNG ASSOCIATES CONSULTING ENGINEERS & ARCHITECTS 8-C 24 St Commercial Aftab, Phase 2 (Edna), Defense Housing Authority, Karachi-75000 Tel: 321-3222444, 321-3221234 FAX: 321-3222999 E-mail: info@youngassociates.com.pk	DWG. NO.: 322AM-011 DRAWN BY: SSW CHECKED BY: SPK SCALE: 1"=30'-0" DATE: 05-09-2021

**LIAQAT UNIVERSITY OF MEDICAL & HEALTH SCIENCES (LUMHS), JAMSHORO
HOSTEL FOR MALE POST GRADUATE STUDENTS**

**TENDER DRAWINGS
ELECTRICAL DRAWINGS**

PREPARED BY:

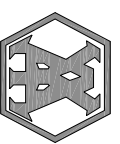

YOUNG ASSOCIATES
CONSULTING ENGINEERS & ARCHITECTS
9-C/24 th Commercial Street, Phase II (Extension) Defence Housing
Authority, Karachi-75500
Tel: 021-36396444, 021-36312244, FAX : 021-36883106
E-mail: info @ young associates .com.pk

LIST OF DRAWINGS

DWG NO.	DRAWING TITLE
EL-101	LIST OF DRAWINGS, LEGENDS & EARTHING DETAIL
EL-102	GENERAL NOTES
EL-103	LIGHT FIXTURE SCHEDULE
EL-104	SINGLE LINE DIAGRAM
EL-105	GROUND FLOOR PLAN LIGHTING & EM LAYOUT
EL-106	FIRST FLOOR PLAN LIGHTING & EM LAYOUT
EL-107	GROUND FLOOR PLAN POWER & ELV LAYOUT
EL-108	FIRST FLOOR PLAN POWER & ELV LAYOUT

MOUNTING HEIGHTS

1	LIGHT SWITCH	4'-0" BOTTOM FROM F.F.L.
2	SOCKETS , TELEPHONE, DATA OUTLETS.	
	a.LOW LEVEL	=0'-8" BOTTOM FROM F.F.L.
	b.HIGH LEVEL	=3'-3" BOTTOM F.F.L.
3	DB HEIGHT.	=6'-0" TOP FROM F.F.L.
4	BELL	=7'-0" MID FROM F.F.L.

NOTE: THE ABOVE DETAILS ARE SHOWN FOR REFERENCE ONLY, THE HEIGHT SHALL BE AS PER ARCHITECT.

LEGEND

SYMBOL	DESCRIPTION
	LIGHT SWITCH
	FAN DIMMER
	13 AMP UNIVERSAL SWITCH SOCKET OUTLET
	13 AMP DUPLEX SWITCH SOCKET OUTLET
	15 AMP SWITCH SOCKET OUTLET
	SPUR SOCKET OUTLET
	ISOLATOR SPN
	ISOLATOR TPN
	VIVACE ROCKER 20A DP 1 GANG SWITCH WITH NEON & EARTH
	RJ-45 WIFI OUTLET
	DUAL RJ-45 DATA & VOICE OUTLET
	RJ-45 DATA OUTLET
	18U DATA RACK
	MAIN DISTRIBUTION BOARD (MDB)
	SUB MAIN DISTRIBUTION BOARD (SMDB)
	DISTRIBUTION BOARD (DB)
	WALL BRACKET FAN
	CEILING FAN
	WIRING FOR SMALL POWER
	WIRING FOR FIRE ALARM
	WIRING FOR TELEPHONE & DATA
	ROAD CROSSING SLEEVES
	MANHOLE 600mmx600mmx900mm
	50mm Ø UPVC CLASS "D" PIPE
	PULL BOX

EARTHING DETAILS

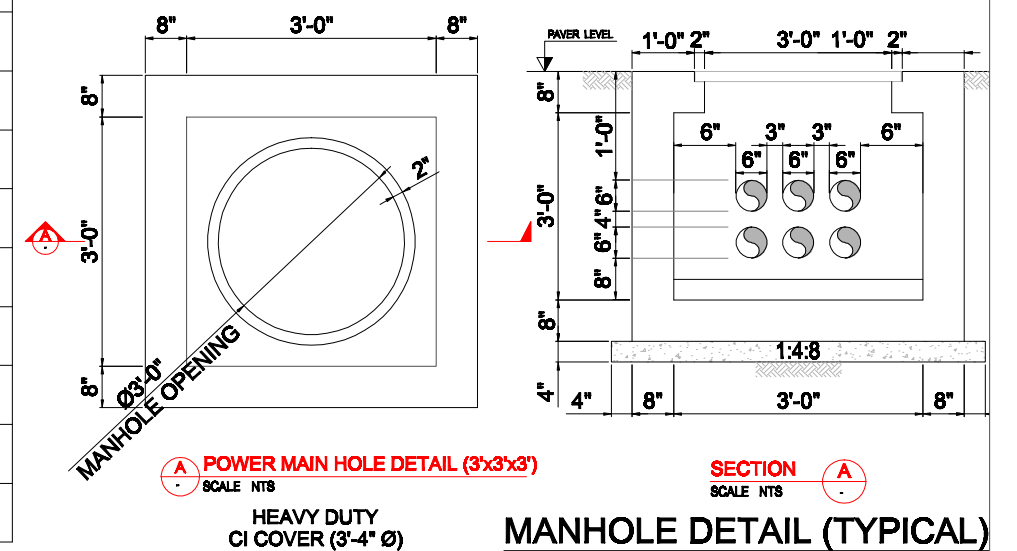
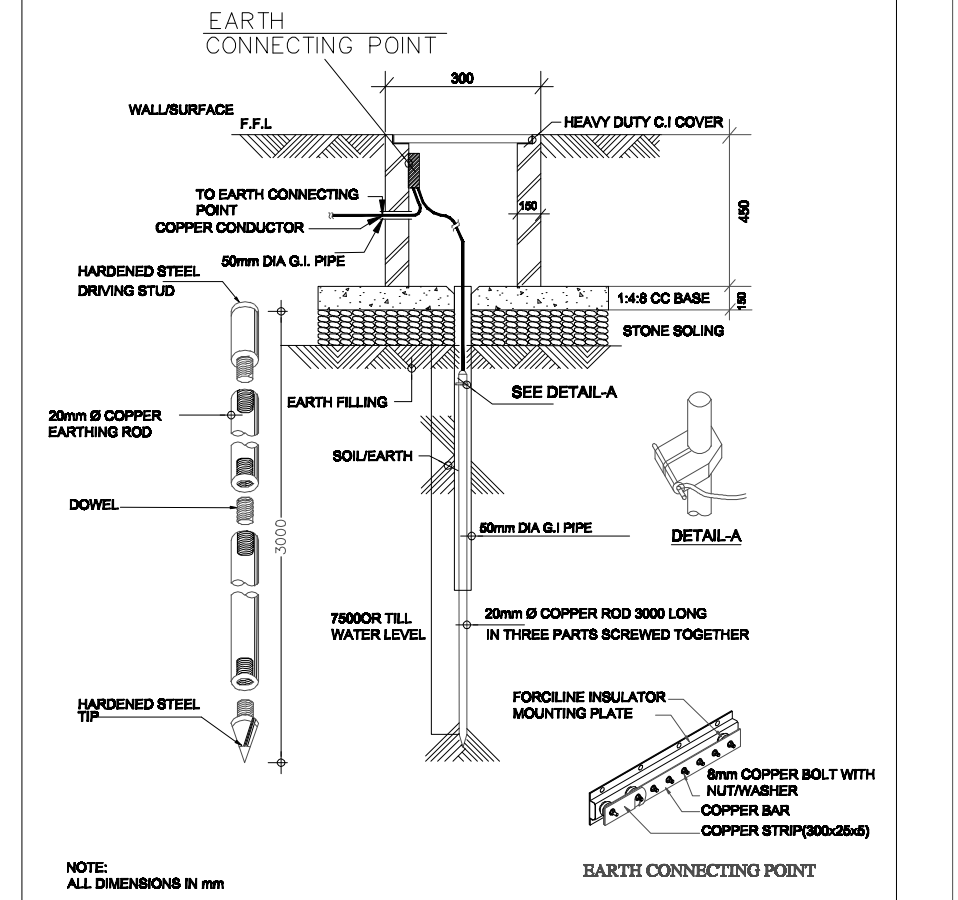

3rd Revision :	_____	Date :	_____
2nd Revision :	_____	Date :	_____
1st Revision :	_____	Date :	_____
ISSUED FOR	TENDER DRAWING	Date :	00-10-2021
CLIENT:	LIAGUAT UNIVERSITY OF MEDICAL & HEALTH SCIENCES, JAMSHORO, SINDH PAKISTAN	DESCRIPTION :	LIST OF DRAWINGS, LEGENDS & EARTHING DETAILS
JOB TITLE :	HOSTEL FOR MALE POST GRADUATE STUDENTS	JOB NO. :	322
	YOUNG ASSOCIATES CONSULTING ENGINEERS & ARCHITECTS 9-C 24 th Commercial Street, Phase 2 (Entr), Defence Housing Authority, Karachi-75500 Tel :021-35306444, 021-35312244 FAX: 021-35883108 E-mail: info@youngassociates.com.pk	DRG. NO. :	322/EL-101
		DRAWN BY :	ZNI
		CHECKED BY :	AH
		SCALE :	NTS
		DATE :	06-08-2021

POWER OUTLETS

- 1 COLOUR FOR ALL SWITCHES, SWITCH SOCKET OUTLETS SHALL BE AS PER CLIENT / CONSULTANT SELECTION.
- 2 THE ELECTRICAL CONTRACTOR SHALL NOTE THAT THE POSITIONS OF ELECTRICAL POINTS, LUMINAIRES, LIGHTING SWITCHES, SWITCH SOCKET OUTLETS ETC. ARE INDICATIVE AND APPROXIMATE AS SHOWN ON DRAWINGS. THE ACTUAL POSITIONS SHALL BE BASED ON THE ARCHITECT'S DRAWING. THE CONTRACTOR IS DEEMED TO HAVE ALLOWED IN HIS TENDER PRICE FOR ALL NECESSARY SITE ADJUSTMENT TO SUIT THE FINAL POSITIONS.
- 3 LOCATIONS FOR ELECTRICAL DISTRIBUTION BOARDS AND SHOWN IN THE PLANS ARE INDICATIVE ONLY. ELECTRICAL CONTRACTOR SHALL VERIFY ON SITE AND PROPOSE THEIR ACTUAL LOCATIONS ON THE SHOP DRAWING FOR CLEARANCE.

CABLES AND ANCILLARY PRODUCTS

- 1 ALL PVC CABLES FOR FINAL SUB-CIRCUIT WIRINGS SHALL BE MULTI-STRAND COPPER CONDUCTORS & INSULATION COLOUR OF THE CABLES SHALL BE AS FOLLOWS :-
LIVE WIRES - RED OR YELLOW OR BLUE FOR SINGLE-PHASE CIRCUIT.
(TO CORRESPOND TO THE PHASE OF THE SUPPLY)
RED, YELLOW, BLUE FOR THREE PHASE CIRCUIT
NEUTRAL WIRES - BLACK
EARTH WIRE GREEN & YELLOW
- 2 SPACE FACTOR OF CONDUIT & TRUNKING SHALL COMPLY WITH BS 7671 CODE OF PRACTICE FOR WIRING OF ELECTRICAL EQUIPMENT.
- 3 ALL SUB-MAINS CIRCUITS TO BE COMPLETE WITH CIRCUIT PROTECTIVE CONDUCTOR(CPC) COMPLYING TO BS 7671 CODE OF PRACTICE
- 4 NEUTRAL & EARTH CABLES FOR EACH DIFFERENT CIRCUIT SHALL BE BROUGHT BACK TO THE SOURCE PANEL AND SHALL NOT BE LOOPED TOGETHER OUTSIDE THE PANEL.

CO-ORDINATION AND INSTALLATION

- 1 THE ELECTRICAL CONTRACTOR SHALL OBTAIN APPROVAL FROM STRUCTURAL ENGINEERS & ARCHITECT FOR PENETRATION THROUGH STRUCTURE AND FLOOR SLABS PRIOR TO CONSTRUCTION.
- 2 ALL MATERIALS/ CABLES USED AND INSTALLATION METHOD SHALL COMPLY WITH THE TECHNICAL SPECIFICATION, STANDARDS, CODE OF PRACTICE AND AUTHORITY REQUIREMENT.
- 3 ALL CABLES/ UNDERGROUND PIPE ROUTES SHOWN ON THE DRAWINGS ARE INDICATIVE ONLY. ELECTRICAL CONTRACTOR SHALL CHECK AND VERIFY THEM ON SITE.
- 4 THE CONTRACTOR IS REQUIRED TO SUBMIT DETAILS OF FINAL ARRANGEMENT AND DIMENSIONAL LAYOUT OF ALL ITEMS OF EQUIPMENT IN RESPECTIVE ROOMS TO SUIT SITE CONDITIONS, ETC. FOR REVIEW BY THE ARCHITECT BEFORE COMMENCEMENT OF INSTALLATION.
- 5 THE TENDERER IS REQUIRED TO CHECK AND HIGHLIGHT IN THEIR TENDER SUBMISSION IF ANY OF THE SWITCHBOARDS, ELECTRICAL EQUIPMENTS, ETC. AS PROVIDED ON THE SPECIFICATION DRAWINGS ARE NOT ADEQUATE TO ACCOMMODATE ALL THE EQUIPMENT TO BE SUPPLIED UNDER THIS CONTRACT.

GENERAL NOTES

- 1 ALL ELECTRICAL WORKS CARRIED OUT SHALL COMPLY WITH THE LATEST STANDARD.
- 2 EARTHING INSTALLATION SYSTEM SHALL COMPLY WITH THE LATEST STANDARD ALL WIRING SHALL BE IN CONCEALED CONDUIT/TRUNKING UNLESS OTHERWISE APPROVED BY CONSULTING ENGINEERS.
- 3 THE POSITIONING OF ALL LIGHTING LUMINAIRES, SWITCH SOCKET OUTLETS, DISTRIBUTION BOARDS ETC. AS SHOWN IN THE DRAWINGS ARE APPROXIMATE ONLY. THE EXACT POSITIONS SHALL BE DETERMINED ON SITE.
- 4 THE ELECTRICAL CONTRACTOR SHALL BE RESPONSIBLE FOR THE ELECTRICAL LOAD BALANCING AND LABELING OF ALL EQUIPMENT AND SWITCHBOARDS THROUGHOUT THE INSTALLATION.
- 5 THE ELECTRICAL CONTRACTOR SHALL BE RESPONSIBLE TO LIAISE WITH ELECTRIC INSPECTOR FOR ALL CLEARANCE, CABLE JOINTING, TESTING AND ELECTRICITY METERING FOR THE INSTALLATION. (IF REQUIRED)
- 6 THE OVERALL RESISTANCE FOR THE EARTHING SYSTEM (ELECTRICAL) SHALL COMPLY WITH LATEST CODES / STANDARDS REQUIREMENTS.
- 7 THE ELECTRICAL CONTRACTOR SHALL BE RESPONSIBLE FOR SEALING OF ALL CABLE PENETRATION OPENINGS BETWEEN FLOOR SLAB, MANHOLE AND WALLS ETC. WITH APPROVED FIRE RATING MATERIAL/CONSULTING ENGINEER'S APPROVAL.
- 8 ELECTRICAL CONTRACTOR SHALL BE RESPONSIBLE FOR SEALING OF ALL CABLE PENETRATION OPENINGS THROUGH ROOF STRUCTURE WALL WITH APPROVED WATER-PROOF MATERIALS AFTER THE INSTALLATION OF CABLES.
- 9 THE ELECTRICAL CONTRACTOR SHALL BACKFILL WITH SAND THE MANHOLES AND DRAWPITS TO COMPLY TO TECHNICAL SPECIFICATIONS.
- 10 ELECTRICAL CONTRACTOR SHALL BE RESPONSIBLE FOR THE EQUIPOTENTIAL EARTHING BONDING TO ALL METAL PARTS COMPLETED BY THE OTHER TRADES TO THE NEARBY ELECTRICAL PANEL IN ACCORDANCE WITH STANDARD.
- 11 ALL WIRING TO LIGHTING LUMINAIRES SHALL COMPRISE OF APPROVED CEILING ROSE FOR INDOOR INSTALLATION AND WEATHERPROOF JUNCTION BOX FOR OUTDOOR INSTALLATION. CONNECTION TO LIGHT FIXTURE SHALL BE BY MEANS OF PVC SHEATHED FLEXIBLE CABLE FOR NORMAL SUPPLY, FR CABLE FOR EMERGENCY SUPPLY.
- 12 OUTDOOR INSTALLATION SHALL BE IN HEAVY DUTY UPVC PIPES.
- 13 THE ELECTRICAL CONTRACTOR SHALL FURNISH ALL NECESSARY LABOUR, MATERIALS AND EQUIPMENTS FOR SATISFACTORY COMPLETION OF THE ENTIRE ELECTRICAL INSTALLATION AS GENERALLY DESCRIBED IN THE SPECIFICATION AND/OR SHOWN ON DRAWINGS.
- 14 ALL LOCATIONS OF EQUIPMENT AND CABLE ROUTES SHOWN ON THE DRAWING ARE APPROXIMATE. THE EXACT LOCATIONS MUST BE CO-ORDINATED ON SITE BEFORE INSTALLATION. FULLY CO-ORDINATED SHOP DRAWINGS MUST BE SUBMITTED TO THE CONSULTANT FOR APPROVAL BEFORE COMMENCEMENT OF WORK.
- 15 ALL SWITCHBOARDS AND DISTRIBUTION BOARDS SHALL BE CONSTRUCTED IN ACCORDANCE WITH THE LATEST STANDARD AND TO THE APPROVAL OF CONSULTANT. THEY SHALL BE PAINTED WITH A COAT OF ANTI-RUST PAINT AND TWO COATS OF SEMI-GLOSS TEAK PAINT OF BEST QUALITY TO THE APPROVAL OF THE CONSULTANT.
- 16 ALL CONDUITS SHALL COMPLY WITH THE LATEST STANDARD AND MINIMUM SIZE SHALL NOT BE LESS THAN 25mm. ALL THREADS IN CONDUITS SHALL BE TREATED WITH ALUMINIUM PAINT OR SIMILAR ANTI-RUST PAINT TO PREVENT CORROSION AT JOINTS AND TERMINATIONS. CONNECTION SHALL BE BY MEANS OF BUSH & COUPLER.
- 17 PHASE SEGREGATION SHALL COMPLY WITH THE LATEST REQUIREMENTS OF THE IEE WIRING REGULATIONS. SEPARATE CONDUITS SHALL BE USED FOR CABLES OF DIFFERENT CIRCUIT CATEGORIES. FOR 3 PHASE FINAL CIRCUITS, SEPARATE CONDUITS SHALL BE USED FOR DIFFERENT CIRCUITS.
- 18 ALL LIGHTING POINTS SHALL BE PROVIDED WITH CIRCUIT PROTECTIVE CONDUCTORS AND ALL METAL PARTS SHALL BE CONTINUOUSLY EARTHED THROUGHOUT.
- 19 THE ELECTRICAL CONTRACTOR SHALL SUPPLY AND INSTALL ALL LIGHT LUMINAIRES AS SHOWN ON THE DRAWINGS. EACH FITTING SHALL HAVE ITS OWN INDEPENDENT SUPPORT REGARDLESS OF SURFACE, RECESSED OR SUSPENDED MOUNTING.
- 20 EACH CIRCUIT SHALL BE TESTED FOR GROUNDS AND SHORTS BY MEANS OF A MEGGER INSULATION RESISTANCE TESTING INSTRUMENT APPLYING A VOLTAGE OF NOT LESS THAN 500V D.C. UPON CIRCUIT UNDER TEST.
- 21 ALL EARTH TESTS SHALL BE CARRIED OUT WITH A 1000V MEGGER TEST INSTRUMENT AND IN ACCORDANCE WITH THE LATEST REQUIREMENTS OF THE IEE WIRING REGULATIONS.

3rd Revision : _____	Date : _____
2nd Revision : _____	Date : _____
1st Revision : _____	Date : _____
ISSUED FOR : TENDER DRAWING	Date : 00-10-2021
CLIENT: LAQUAT UNIVERSITY OF MEDICAL & HEALTH SCIENCES, JAMSHORO, SINDH PAKISTAN	DESCRIPTION : GENERAL NOTES
JOB TITLE: HOSTEL FOR MALE POST GRADUATE STUDENTS	JOB NO : 322
 YOUNG ASSOCIATES CONSULTING ENGINEERS & ARCHITECTS 9-C 24 th Commercial Street, Phase 2 (Estr), Defence Housing Authority, Karachi-7500 Tel :021-35306444, 021-35312244 FAX: 021-3583108 E-mail: info@youngassociates.com.pk	DRG. NO. : 222/EL-102
	DRAWN BY : ZN
	CHECKED BY : AH
	SCALE : NTS
	DATE : 06-08-2021

SYMBOL		FIXTURE IMAGE	
TYPE-A	LED LIGHT FIXTURE		
HOUSING	UV SHIELD POLY CARBONATE WITH STAINLESS STEEL BRACKET		
MOUNTING	SURFACE		
LAMP TYPE	LED		
WATT	40 WATTS		
IP RATING	IP20		
MAKE	PIERLITE / nVC / PHILIPS		

SYMBOL		FIXTURE IMAGE	
TYPE-B	LED DOWN LIGHT		
HOUSING	ALUMINUM / DIE CAST WITH GLASS COVER		
MOUNTING	SURFACE MOUNTED		
LAMP TYPE	LED		
WATT	18 WATTS		
IP RATING	IP20		
MAKE	PIERLITE / nVC / PHILIPS		

SYMBOL		FIXTURE IMAGE	
TYPE-C	LED WALL BRACKET LIGHT		
HOUSING	UV SHIELD POLY CARBONATE WITH STAINLESS STEEL BRACKET		
MOUNTING	WALL		
LAMP TYPE	LED		
WATT	20 WATTS		
IP RATING	IP54		
MAKE	PIERLITE / nVC / PHILIPS		

SYMBOL		FIXTURE IMAGE	
TYPE-D	PENDENT LIGHT		
HOUSING	DECORATIVE		
MOUNTING	SUSPENDED		
LAMP TYPE	LED		
WATT	20 WATTS		
IP RATING	IP20		
MAKE	PIERLITE / nVC / PHILIPS		

SYMBOL		FIXTURE IMAGE	
TYPE-Q	EMERGENCY EXIT LIGHT (MAINTAINED TYPE) (3 HOURS BATTERY BACKUP)		
HOUSING	POLY CARBONATE		
REFLECTOR	AS PER MANUFACTURER		
MOUNTING	SURFACE MOUNTED		
LAMP TYPE	LED		
WATT	8 WATTS		
IP RATING	IP20		
MAKE	TECHNOWARE / COOPER / MENVIER		

SYMBOL		FIXTURE IMAGE	
TYPE-R	EMERGENCY LIGHT (NON-MAINTAINED TYPE) (3 HOURS BATTERY BACKUP)		
HOUSING	POLY CARBONATE		
REFLECTOR	AS PER MANUFACTURER		
MOUNTING	SURFACE		
LAMP TYPE	LED		
WATT	8 WATTS		
IP RATING	IP65		
MAKE	TECHNOWARE / COOPER / MENVIER		

NOTE: FIXTURE IMAGES ARE SHOWN FOR REFERENCE ONLY
CONTRACTOR SHOULD SUBMIT DATA SHEETS ALONG
WITH FIXTURE SAMPLE TO CLIENT/ENGINEER FOR APPROVAL

3rd Revision :	_____	Date :	_____
2nd Revision :	_____	Date :	_____
1st Revision :	_____	Date :	_____
ISSUED FOR	TENDER DRAWING	Date :	00-10-2021
CLIENT:	LIAGUAT UNIVERSITY OF MEDICAL & HEALTH SCIENCES, JAMSHORO, SINDH PAKISTAN	DESCRIPTION :	LIGHTING FIXTURE SCHEDULE
JOB TITLE :	HOSTEL FOR MALE POST GRADUATE STUDENTS	JOB NO :	322
 YOUNG ASSOCIATES	CONSULTING ENGINEERS & ARCHITECTS	DRG. NO. :	222/EL-103
9-C 24 th Commercial Street, Phase 2 (Estr), Defence Housing Authority, Karachi-75500	Tel :021-35306444, 021-35312244	DRAWN BY :	ZNI
FAX: 021-35883108	E-mail: info@youngassociates.com.pk	CHECKED BY :	AH
		SCALE :	NTS
		DATE :	06-08-2021

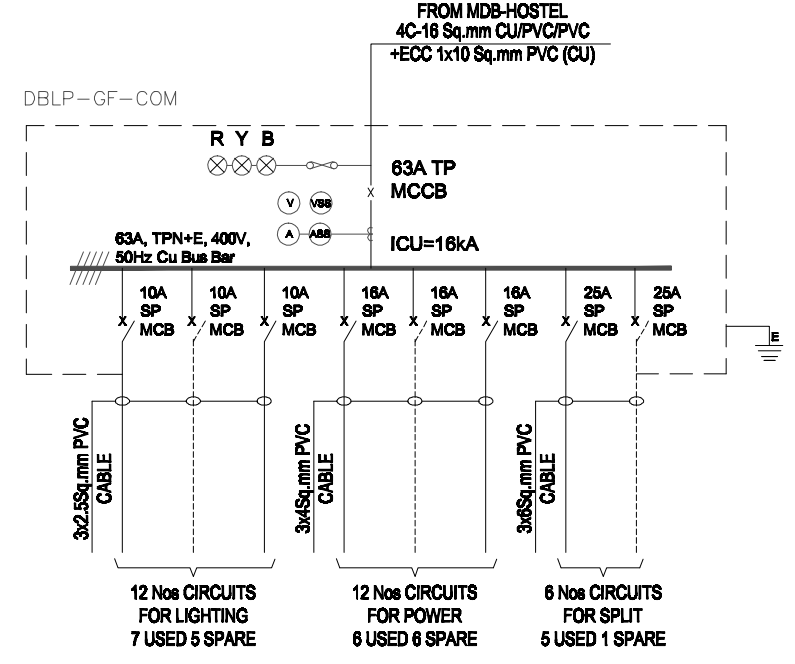
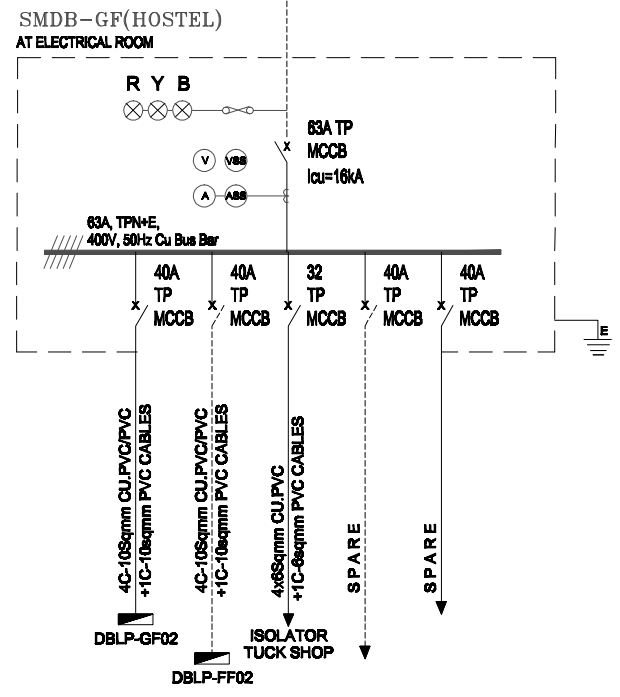
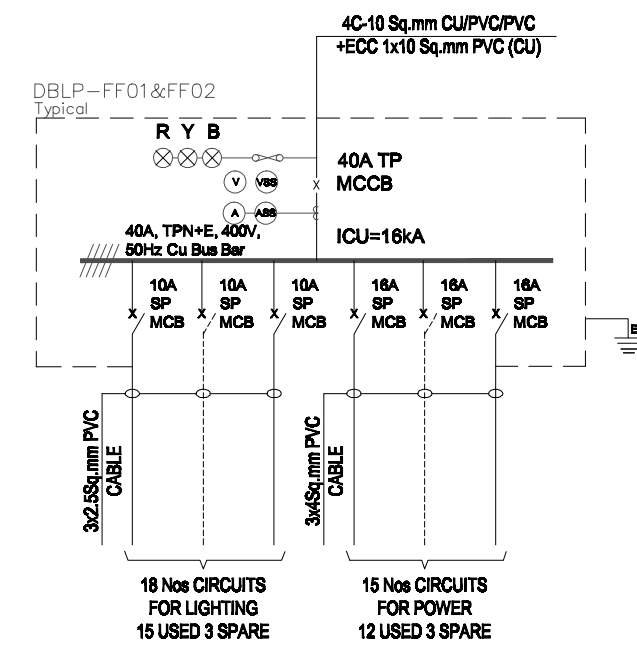
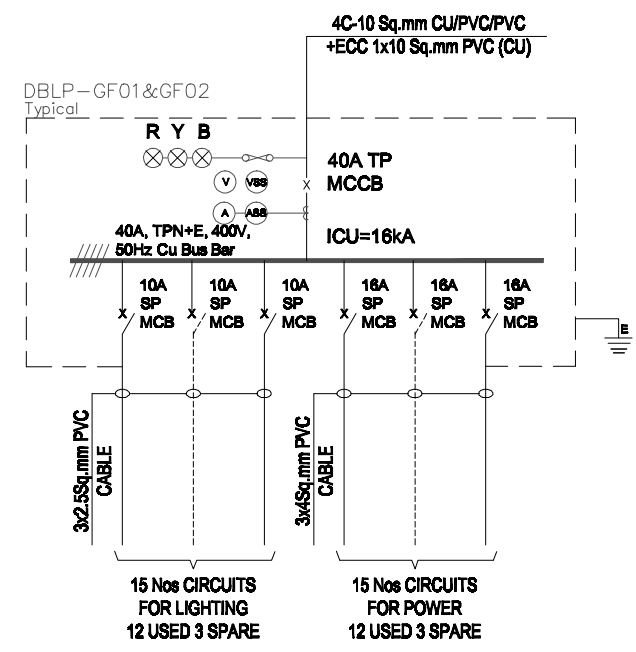
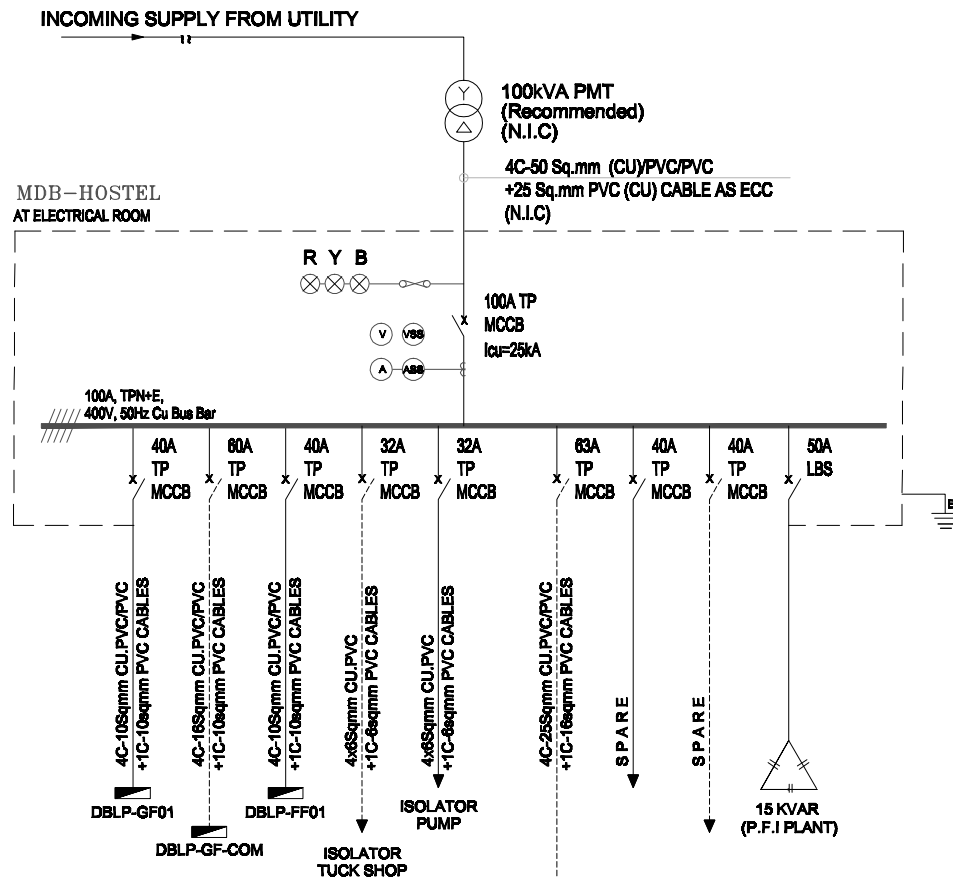

LEGENDS	
SYMBOL	DESCRIPTION
	DIGITAL / ANALOG VOLTS SELECTOR SWITCH
	DIGITAL / ANALOG AMPS SELECTOR SWITCH
	PHASE INDICATION LAMPS (R,Y,B)
	SINGLE POLE MINIATURE CIRCUIT BREAKER (MCB)
	MOULDED CASE CIRCUIT BREAKER (MCCB)
	CURRENT TRANSFORMER (CT)
	FUSE
	EARTH PIT WITH EARTH ROD

- NOTES**
1. THE ELECTRICAL CONTRACTOR SHALL BE RESPONSIBLE FOR THE ELECTRICAL LOAD BALANCING AND LABELING OF ALL EQUIPMENT AND SWITCHBOARDS THROUGHOUT THE INSTALLATION.
 2. THE ELECTRICAL CONTRACTOR SHALL BE RESPONSIBLE FOR SEALING OF ALL CABLE PENETRATION OPENINGS BETWEEN FLOOR SLAB, MANHOLE AND WALLS ETC. WITH APPROVED FIRE RATING MATERIAL/CONSULTING ENGINEER'S APPROVAL.
 3. ALL DISTRIBUTION BOARDS SHALL BE CONSTRUCTED IN ACCORDANCE WITH THE LATEST STANDARD AND CONTRACTOR SHOULD SUBMIT SHOP DRAWINGS WITH ALL RELEVANT DETAILS TO THE CONSULTANT FOR APPROVAL. THEY SHALL BE PAINTED WITH A COAT OF ANTI-RUST PAINT AND TWO COATS OF SEMI-GLOSS TEAK PAINT OF BEST QUALITY TO THE APPROVAL OF THE ARCHITECT.

3rd Revision : _____	Date : _____
2nd Revision : _____	Date : _____
1st Revision : _____	Date : _____
ISSUED FOR : TENDER DRAWING	Date : 00-10-2021
CLIENT: LIAQIAT UNIVERSITY OF MEDICAL & HEALTH SCIENCES, JAMSHORO, SINDH PAKISTAN	DESCRIPTION: SINGLE LINE DIAGRAM
JOB TITLE: HOSTEL FOR MALE POST GRADUATE STUDENTS	JOB NO: 322
YOUNG ASSOCIATES CONSULTING ENGINEERS & ARCHITECTS 8-C 24 th Commercial Street, Phase 2 (E-24), Defence Housing Authority, Karachi-75200 Tel: 021-35395444, 021-35312244 FAX: 021-35395988 E-mail: info@youngassociates.com.pk	DRG. NO.: 322EL-104
	DRAWN BY: ZN
	CHECKED BY: AH
	SCALE: NTS
	DATE: 06-08-2021

A B C D F H K L P R S T V W X Y Z Z₁ Z₂ Z₃ Z₄ Z₅ Z₆ Z₇ Z₈ Z₉ Z₁₀ Z₁₁ Z₁₂ Z₁₃ Z₁₄ Z₁₅ Z₁₆ Z₁₇ Z₁₈ Z₁₉ Z₂₀ Z₂₁ Z₂₂ Z₂₃ Z₂₄ Z₂₅ Z₂₆ Z₂₇ Z₂₈ Z₂₉ Z₃₀ Z₃₁ Z₃₂ Z₃₃ Z₃₄ Z₃₅ Z₃₆ Z₃₇ Z₃₈ Z₃₉ Z₄₀

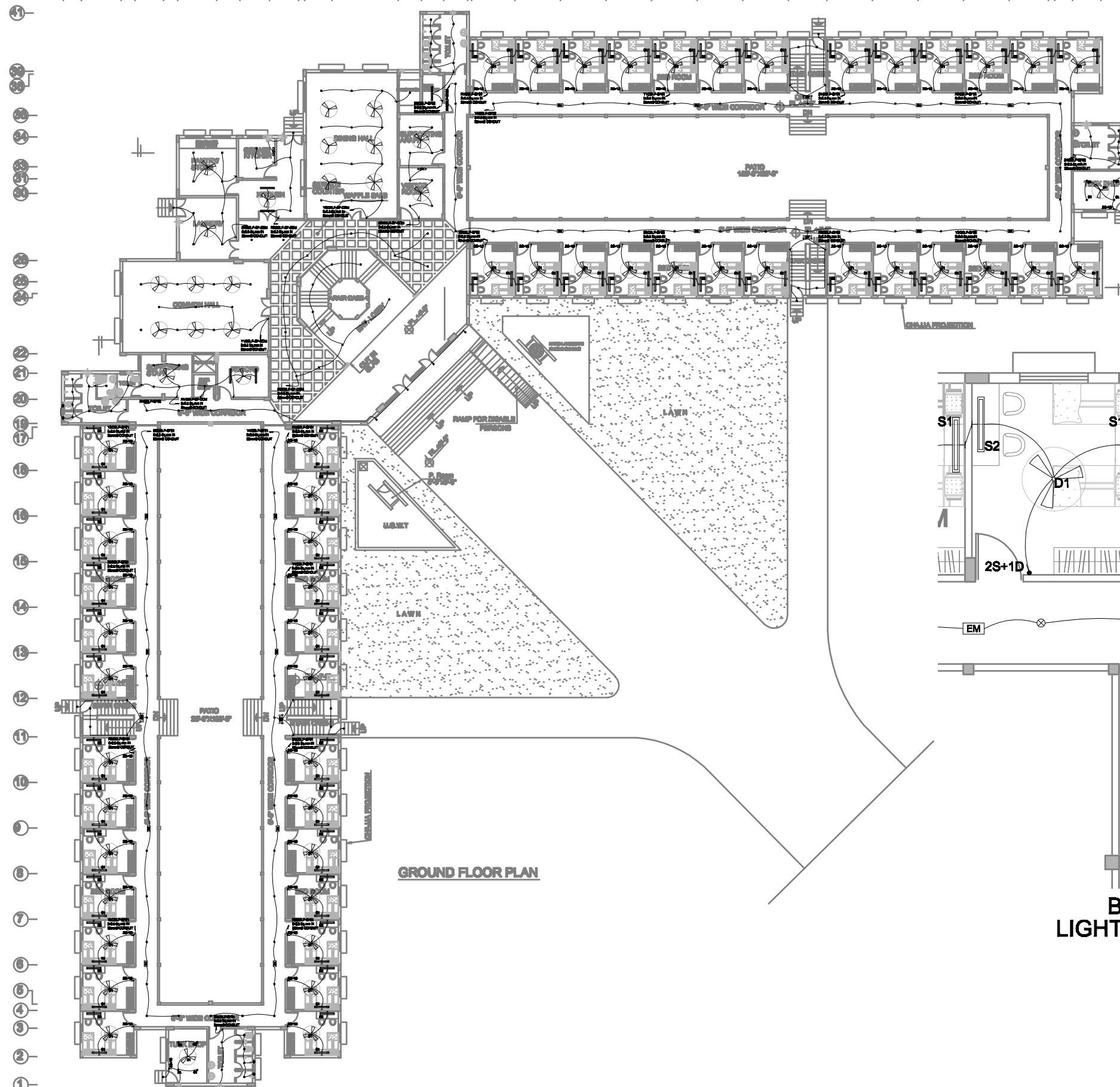
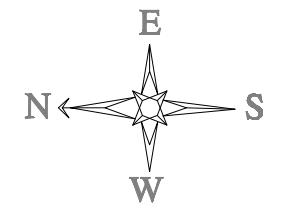

GROUND FLOOR PLAN

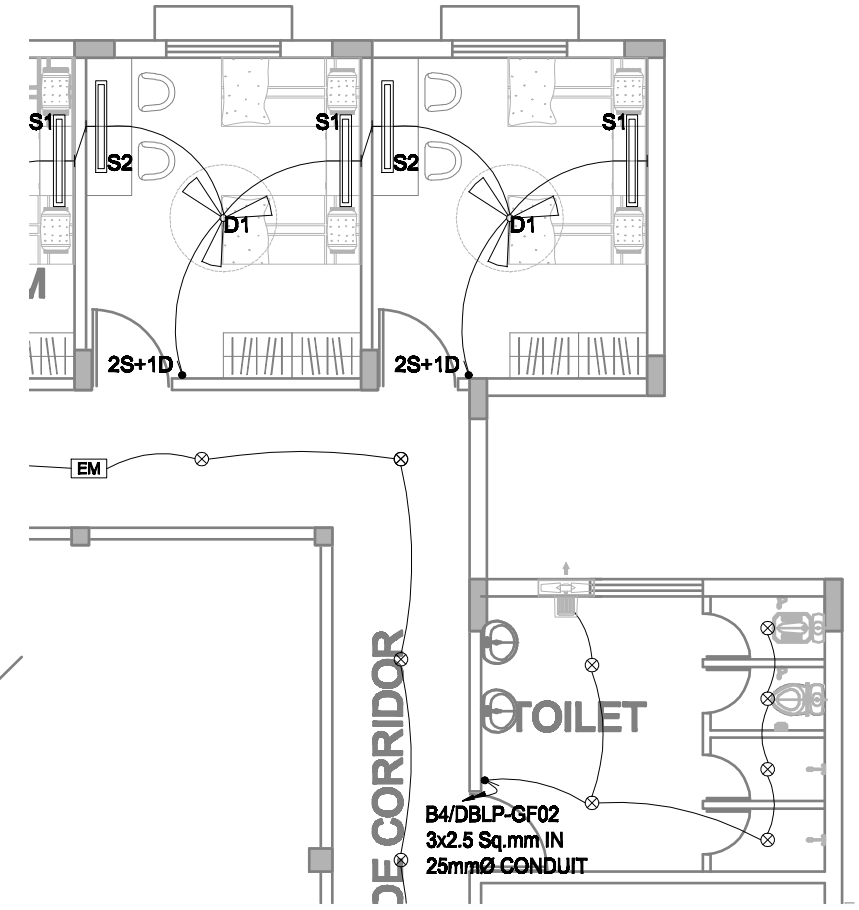

BLOWUP PLAN
LIGHTING & EM LAYOUT

A B D E G J M N Q U

3rd Revision : _____	Date : _____
2nd Revision : _____	Date : _____
1st Revision : _____	Date : _____
ISSUED FOR : TENDER DRAWING	Date : 00-10-2021
CLIENT : LAQIAT UNIVERSITY OF MEDICAL & HEALTH SCIENCES, JAMSHORO, SINDH PAKISTAN	DESCRIPTION : GROUND FLOOR PLAN LIGHTING & EM LAYOUT
JOB TITLE : HOSTEL FOR MALE POST GRADUATE STUDENTS	JOB NO : 322
YOUNG ASSOCIATES CONSULTING ENGINEERS & ARCHITECTS 9-C 24 th Commercial Street, Phase 2 (E:st), Defence Housing Authority, Karachi-75500 Tel: 021-36398444, 021-36312344 Fax: 021-36883108 E-mail: info@youngassociates.com.pk	DRG. NO. : 322/EL-106
	DRAWN BY : ZN
	CHECKED BY : AH
	SCALE : 1"=30'-0"
	DATE : 05-08-2021

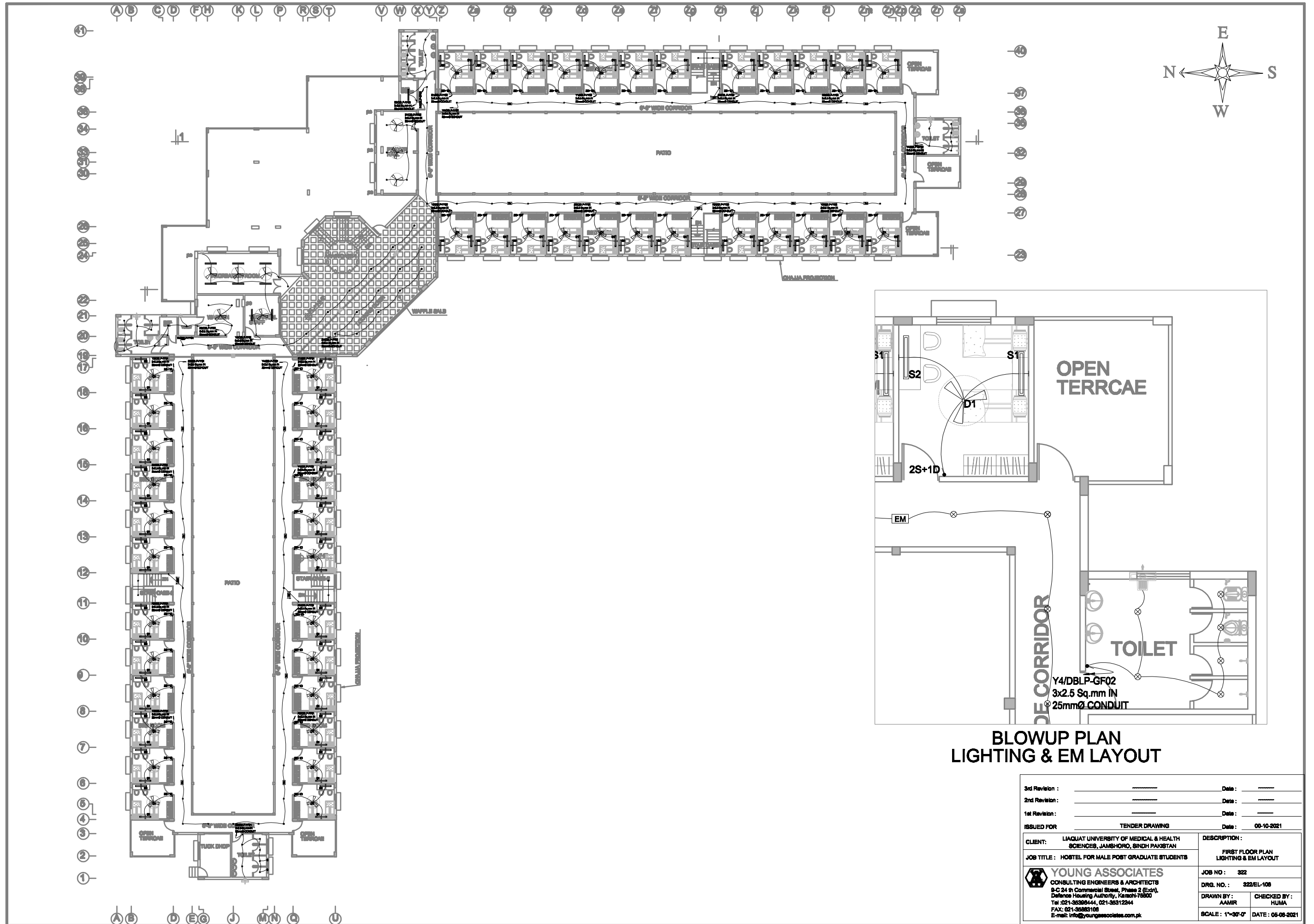

**BLOWUP PLAN
LIGHTING & EM LAYOUT**

3rd Revision :	_____	Date :	_____
2nd Revision :	_____	Date :	_____
1st Revision :	_____	Date :	_____
ISSUED FOR	TENDER DRAWING	Date :	00-10-2021
CLIENT:	IAQUAT UNIVERSITY OF MEDICAL & HEALTH SCIENCES, JAMSHORO, SINDH PAKISTAN	DESCRIPTION :	FIRST FLOOR PLAN LIGHTING & EM LAYOUT
JOB TITLE :	HOSTEL FOR MALE POST GRADUATE STUDENTS	JOB NO :	322
YOUNG ASSOCIATES CONSULTING ENGINEERS & ARCHITECTS 9-C 24 th Commercial Street, Phase 2 (Edn), Defence Housing Authority, Karachi-75500 Tel :021-3539444, 021-35312244 FAX: 021-35393108 E-mail: info@youngassociates.com.pk		DRG. NO. :	322/EL-108
		DRAWN BY :	AAMIR
		CHECKED BY :	HUMA
		SCALE :	1"=30'-0"
		DATE :	05-06-2021

A B C D F H K L P R S T V W X Y Z Z1 Z2 Z3 Z4 Z5 Z6 Z7 Z8 Z9 Z10 Z11 Z12 Z13 Z14 Z15 Z16 Z17 Z18 Z19 Z20 Z21 Z22 Z23 Z24 Z25 Z26 Z27 Z28

41
39
38
37
36
35
34
33
32
31
30
29
28
27
26
25
24
23
22
21
20
19
18
17
16
15
14
13
12
11
10
9
8
7
6
5
4
3
2
1

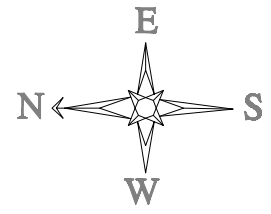
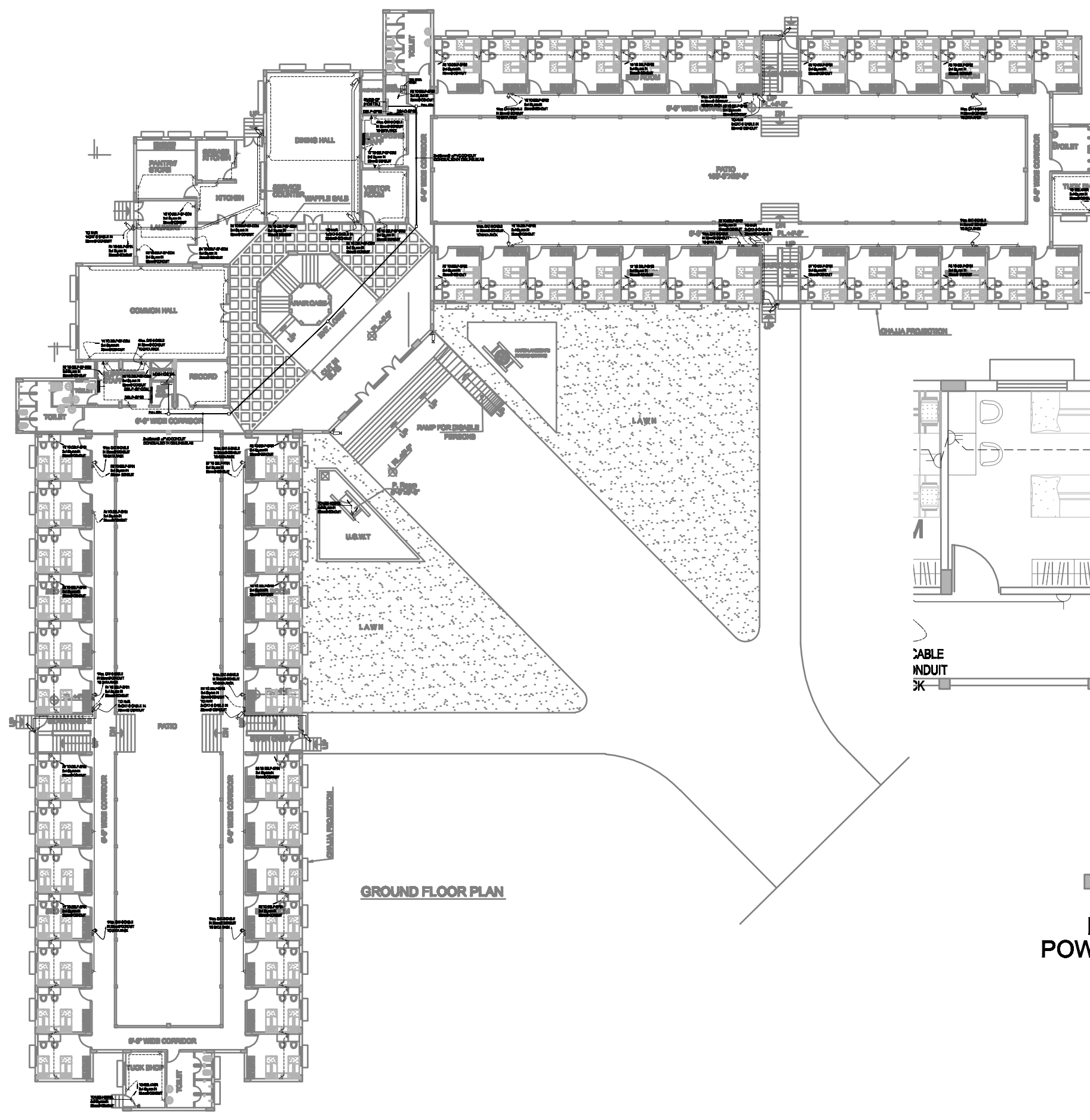

GROUND FLOOR PLAN

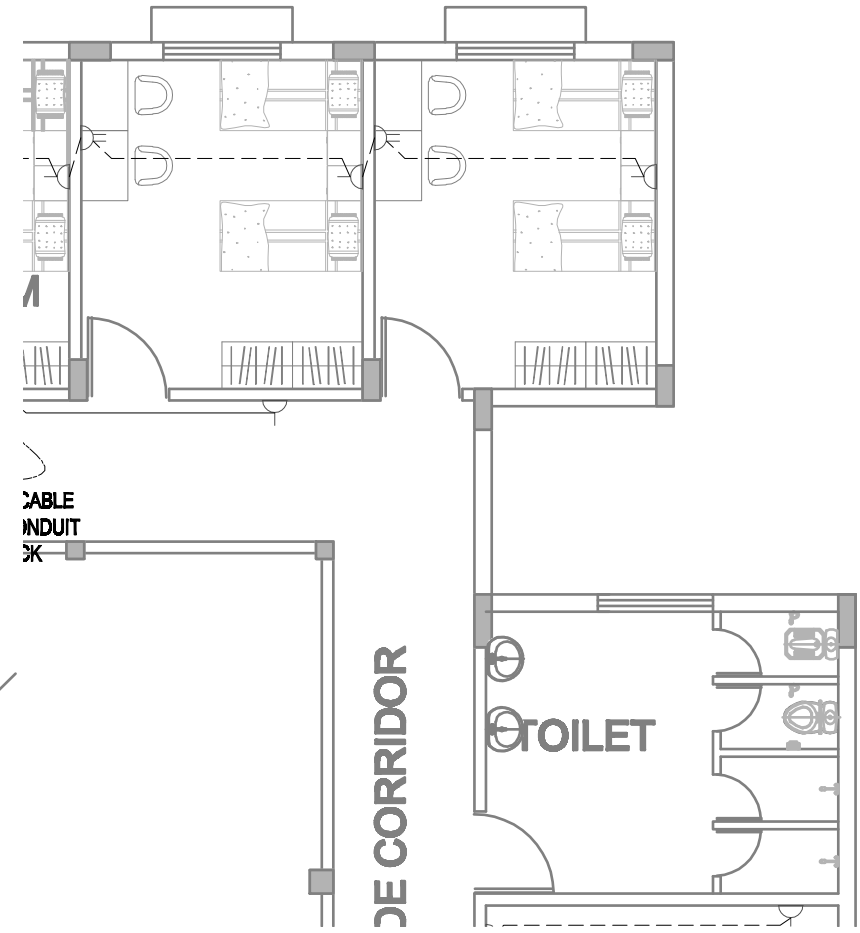

BLOWUP PLAN
POWER & ELV LAYOUT

A B D E G J M N Q U

3rd Revision :	_____	Date :	_____
2nd Revision :	_____	Date :	_____
1st Revision :	_____	Date :	_____
ISSUED FOR	TENDER DRAWING	Date :	00-10-2021
CLIENT:	LAGUAT UNIVERSITY OF MEDICAL & HEALTH SCIENCES, JAMBHORO, SINDH PAKISTAN	DESCRIPTION:	GROUND FLOOR PLAN POWER & ELV LAYOUT
JOB TITLE:	HOSTEL FOR MALE POST GRADUATE STUDENTS	JOB NO. :	322
YOUNG ASSOCIATES CONSULTING ENGINEERS & ARCHITECTS 9-C 24 th Commercial Street, Phase 2 (Edn), Defence Housing Authority, Karachi-75500 Tel : 021-3539444, 021-35312244 FAX: 021-35393108 E-mail: info@youngassociates.com.pk		DRG. NO. :	322/EL-107
		DRAWN BY :	ZN
		CHECKED BY :	AH
		SCALE :	1"=30'-0"

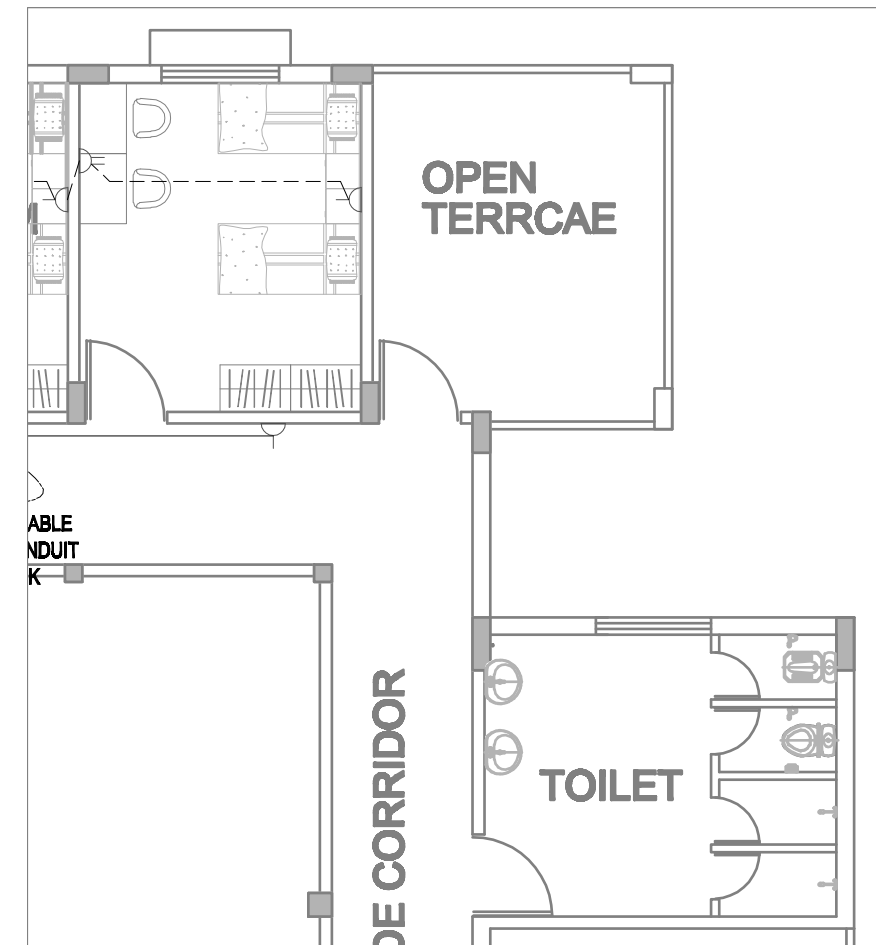
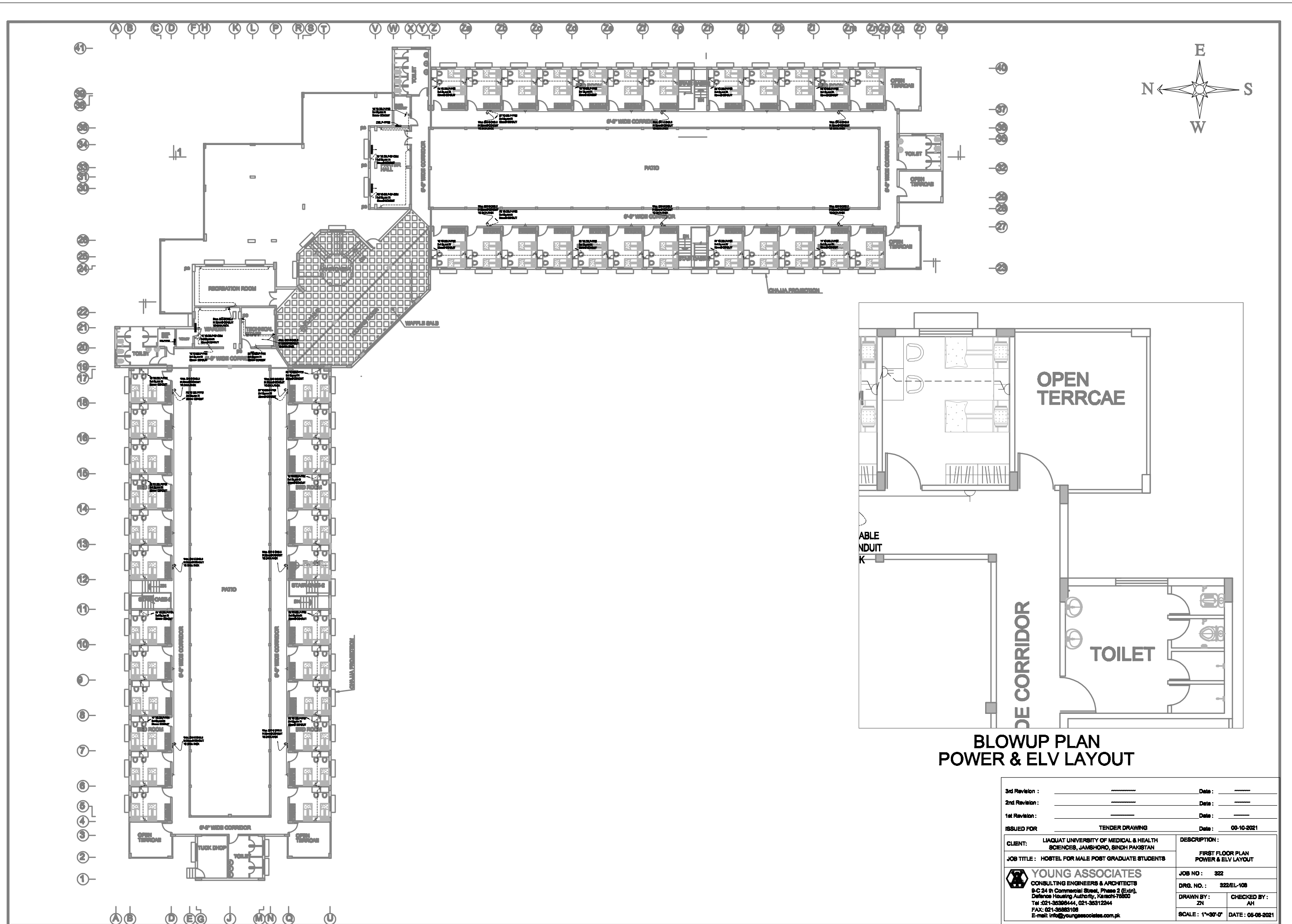
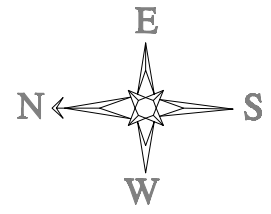

**BLOWUP PLAN
POWER & ELV LAYOUT**

3rd Revision :	_____	Date :	_____
2nd Revision :	_____	Date :	_____
1st Revision :	_____	Date :	_____
ISSUED FOR	TENDER DRAWING	Date :	00-10-2021
CLIENT:	LAGUAT UNIVERSITY OF MEDICAL & HEALTH SCIENCES, JAMSHORO, SINDH PAKISTAN	DESCRIPTION :	FIRST FLOOR PLAN POWER & ELV LAYOUT
JOB TITLE :	HOSTEL FOR MALE POST GRADUATE STUDENTS	JOB NO :	322
YOUNG ASSOCIATES CONSULTING ENGINEERS & ARCHITECTS B-C 24 th Commercial Street, Phase 2 (Edn), Defence Housing Authority, Karachi-75500 Tel :021-3539444, 021-35312344 FAX: 021-35383108 E-mail: info@youngassociates.com.pk		DRG. NO. :	322/EL-108
		DRAWN BY :	ZNI
		CHECKED BY :	AH
		SCALE :	1"=30'-0"
		DATE :	05-06-2021